

100%

ONE HUNDRED PERCENT

COMPREHENSIVE
AUTHORITATIVE
WHAT YOU NEED

ONE HUNDRED PERCENT

Defend corporate systems and wireless networks against intrusion

Apply the latest techniques for protecting information, testing your system, and responding to attacks

Learn from recognized experts in government, media, academic, and corporate security



Network Security

Bible

The first comprehensive, A-to-Z guide to network security, by nationally acclaimed authorities in the field

Eric Cole, PhD, CISSP; Ronald Krutz, PhD, PE, CISSP, ISSEP;
and James W. Conley, CISSP, Security+, CCNA

www.allitebooks.com

Network Security Bible

Dr. Eric Cole, Dr. Ronald Krutz, and James W. Conley



WILEY

Wiley Publishing, Inc.

Network Security Bible

Network Security Bible

Dr. Eric Cole, Dr. Ronald Krutz, and James W. Conley



WILEY

Wiley Publishing, Inc.

Network Security Bible

Published by
Wiley Publishing, Inc.
10475 Crosspoint Boulevard
Indianapolis, IN 46256
www.wiley.com

Copyright © 2005 by Wiley Publishing, Inc., Indianapolis, Indiana

Published simultaneously in Canada

ISBN: 0-7645-7397-7

Manufactured in the United States of America

10 9 8 7 6 5 4 3 2 1

1B/SZ/RS/QU/IN

No part of this publication may be reproduced, stored in a retrieval system or transmitted in any form or by any means, electronic, mechanical, photocopying, recording, scanning or otherwise, except as permitted under Sections 107 or 108 of the 1976 United States Copyright Act, without either the prior written permission of the Publisher, or authorization through payment of the appropriate per-copy fee to the Copyright Clearance Center, 222 Rosewood Drive, Danvers, MA 01923, (978) 750-8400, fax (978) 646-8600. Requests to the Publisher for permission should be addressed to the Legal Department, Wiley Publishing, Inc., 10475 Crosspoint Blvd., Indianapolis, IN 46256, (317) 572-3447, fax (317) 572-4355, E-Mail: brandreview@wiley.com.

LIMIT OF LIABILITY/DISCLAIMER OF WARRANTY: THE PUBLISHER AND THE AUTHOR MAKE NO REPRESENTATIONS OR WARRANTIES WITH RESPECT TO THE ACCURACY OR COMPLETENESS OF THE CONTENTS OF THIS WORK AND SPECIFICALLY DISCLAIM ALL WARRANTIES, INCLUDING WITHOUT LIMITATION WARRANTIES OF FITNESS FOR A PARTICULAR PURPOSE. NO WARRANTY MAY BE CREATED OR EXTENDED BY SALES OR PROMOTIONAL MATERIALS. THE ADVICE AND STRATEGIES CONTAINED HEREIN MAY NOT BE SUITABLE FOR EVERY SITUATION. THIS WORK IS SOLD WITH THE UNDERSTANDING THAT THE PUBLISHER IS NOT ENGAGED IN RENDERING LEGAL, ACCOUNTING, OR OTHER PROFESSIONAL SERVICES. IF PROFESSIONAL ASSISTANCE IS REQUIRED, THE SERVICES OF A COMPETENT PROFESSIONAL PERSON SHOULD BE SOUGHT. NEITHER THE PUBLISHER NOR THE AUTHOR SHALL BE LIABLE FOR DAMAGES ARISING HEREFROM. THE FACT THAT AN ORGANIZATION OR WEBSITE IS REFERRED TO IN THIS WORK AS A CITATION AND/OR A POTENTIAL SOURCE OF FURTHER INFORMATION DOES NOT MEAN THAT THE AUTHOR OR THE PUBLISHER ENDORSES THE INFORMATION THE ORGANIZATION OR WEBSITE MAY PROVIDE OR RECOMMENDATIONS IT MAY MAKE. FURTHER, READERS SHOULD BE AWARE THAT INTERNET WEBSITES LISTED IN THIS WORK MAY HAVE CHANGED OR DISAPPEARED BETWEEN WHEN THIS WORK WAS WRITTEN AND WHEN IT IS READ.

For general information on our other products and services or to obtain technical support, please contact our Customer Care Department within the U.S. at (800) 762-2974, outside the U.S. at (317) 572-3993 or fax (317) 572-4002.

Wiley also publishes its books in a variety of electronic formats. Some content that appears in print may not be available in electronic books.

Library of Congress Cataloging-in-Publication Data

Cole, Eric.

Network security bible / Eric Cole, Ronald Krutz, James W. Conley.

p. cm.

ISBN 0-7645-7397-7 (pbk.)

1. Computer security. 2. Computer networks — Security measures. I. Krutz, Ronald L., 1938- II. Conley,

James W. III. Title.

QA76.9.A25C5985 2005

005.8—dc22

2004025696

Trademarks: Wiley, the Wiley logo, and related trade dress are registered trademarks of John Wiley & Sons, Inc. and/or its affiliates, in the United States and other countries, and may not be used without written permission. All other trademarks are the property of their respective owners. Wiley Publishing, Inc., is not associated with any product or vendor mentioned in this book.

*To Kerry, Jackson, and Anna, who provide constant
inspiration and energy. EBC*

To my family—the real meaning of life. RLK

To my beautiful wife, Jill, and handsome children, Matthew and Andrew. JWC

Credits

Acquisitions Editor

Carol Long

Technical Editor

Patrick Santy

Editorial Manager

Mary Beth Wakefield

Vice President & Executive Group**Publisher**

Richard Swadley

Vice President and Publisher

Joseph B. Wikert

Project Coordinators

Maridee Ennis

Erin Smith

Graphics and Production Specialists

Sean Decker

Carrie A. Foster

Denny Hager

Joyce Haughey

Quality Control Technician

Amanda Briggs

John Greenough

Leeann Harney

Proofreading and Indexing

TECHBOOKS Production Services

About the Authors

Dr. Eric Cole is the best-selling author of *Hackers Beware* and one of the highest-rated speakers on the training circuit. Eric has earned rave reviews for his ability to educate and train network security professionals worldwide. He has appeared on CNN and has been interviewed on various TV programs, including “CBS News” and “60 Minutes.”

An information security expert for more than 15 years, Eric holds several professional certificates and helped develop several certifications and corresponding courses. He obtained his M.S. in Computer Science at the New York Institute of Technology and recently earned his Doctorate degree in Network Steganography from Pace University.

Eric has created and directed corporate security programs for several large organizations, built numerous security consulting practices, and worked for more than five years at the Central Intelligence Agency. He is currently Chief Scientist for The Sytex Group, Inc Information Research Center, where he heads up cutting-edge research.

Dr. Ronald L. Krutz is a Senior Information Security Researcher in the Advanced Technology Research center of The Sytex Group, Inc. In this capacity, he works with a team responsible for advancing the state of the art in information systems security. He has more than 30 years of experience in distributed computing systems, computer architectures, real-time systems, information assurance methodologies, and information security training. He holds the CISSP and ISSEP information security certifications.

He has been an information security consultant at REALTECH Systems Corporation and BAE Systems, an associate director of the Carnegie Mellon Research Institute (CMRI), and a professor in the Carnegie Mellon University Department of Electrical and Computer Engineering. Ron founded the CMRI Cybersecurity Center and was founder and director of the CMRI Computer, Automation, and Robotics Group. He is a former lead instructor for the (ISC)² CISSP Common Body of Knowledge review seminars. Ron is also a Distinguished Special Lecturer in the Center for Forensic Computer Investigation at the University of New Haven, a part-time instructor in the University of Pittsburgh Department of Electrical and Computer Engineering, and a Registered Professional Engineer. In addition, he is the author of six best-selling publications in the area of information systems security. Ron holds B.S., M.S., and Ph.D. degrees in Electrical and Computer Engineering.

James W. Conley is a Senior Researcher in the Advanced Technology Research Center of The Sytex Group, Inc. He has more than 20 years of experience in security, beginning as a Security Officer in the United States Navy, then as a Senior Security Specialist on CIA development efforts, and now as a security professional with certifications of CISSP/Security+/CCNA. Additionally, he has over 18 years of experience

in project management, software engineering, and computer science. He has a strong foundation in personnel management, software development, and systems integration. Prior to joining Sytex, he held prominent positions in various companies, such as Chief Information Officer, Director of Security, Vice President of Security Solutions, and finally as President/CEO (ThinkSecure, LLC). Jim has extensive experience developing applications and securing systems in both UNIX and Windows environments, and has a B.S. in Physics, M.S. in Computer Science, and is pursuing a Ph.D. in Machine Learning at George Mason University, Fairfax, Virginia.

Contents at a Glance

Acknowledgments	xxv
Introduction	xxvii
Part I: Security Principles and Practices	1
Chapter 1: Information System Security Principles	3
Chapter 2: Information System Security Management	43
Chapter 3: Access Control Considerations	79
Part II: Operating Systems and Applications	97
Chapter 4: Windows Security	99
Chapter 5: UNIX and Linux Security	155
Chapter 6: Web Browser and Client Security	201
Chapter 7: Web Security	237
Chapter 8: E-mail Security	273
Chapter 9: Domain Name System	309
Chapter 10: Server Security	333
Part III: Network Security Fundamentals	365
Chapter 11: Network Protocols	367
Chapter 12: Wireless Security	381
Chapter 13: Network Architecture Fundamentals	417
Part IV: Communications	445
Chapter 14: Secret Communication	447
Chapter 15: Covert Communication	479
Chapter 16: Applications of Secure/Covert Communication	529
Part V: The Security Threat and the Response	555
Chapter 17: Intrusion Detection and Response	557
Chapter 18: Security Assessments, Testing, and Evaluation	591
Chapter 19: Putting Everything Together	613
Index	625

Contents

Acknowledgments xxv

Introduction xxvii

Part I: Security Principles and Practices 1

Chapter 1: Information System Security Principles 3

- Key Principles of Network Security 3
 - Confidentiality 4
 - Integrity 4
 - Availability 4
 - Other important terms 4
- Formal Processes 5
 - The systems engineering process 5
 - The Information Assurance Technical Framework 6
 - The Information Systems Security Engineering process 11
 - The Systems Development Life Cycle 21
 - Information systems security and the SDLC 22
- Risk Management 31
 - Definitions 32
 - Risk management and the SDLC 33
- Summary 42

Chapter 2: Information System Security Management 43

- Security Policies 43
 - Senior management policy statement 44
 - Standards, guidelines, procedures, and baselines 45
- Security Awareness 46
 - Training 46
 - Measuring awareness 47
- Managing the Technical Effort 48
 - Program manager 48
 - Program management plan 48
 - Systems engineering management plan 48
- Configuration Management 56
 - Primary functions of configuration management 56
 - Definitions and procedures 57

Business Continuity and Disaster Recovery Planning	59
Business continuity planning	60
Disaster recovery planning	64
Physical Security	67
Controls	68
Environmental issues	72
Fire suppression	73
Object reuse and data remanence	74
Legal and Liability Issues	75
Types of computer crime	75
Electronic monitoring	76
Liability	76
Summary	77
Chapter 3: Access Control Considerations	79
Control Models	79
Discretionary access control	79
Mandatory access control	80
Non-discretionary access control	81
Types of Access Control Implementations	81
Preventive/Administrative	81
Preventive/Technical	82
Preventive/Physical	82
Detective/Administrative	82
Detective/Technical	83
Detective/Physical	83
Centralized/Decentralized access controls	84
Identification and Authentication	84
Passwords	85
Biometrics	85
Single Sign-On	86
Databases	90
Relational databases	90
Other database types	92
Remote Access	93
RADIUS	93
TACACS and TACACS+	93
Password Authentication Protocol	94
Challenge Handshake Authentication Protocol	94
Callback	95
Summary	95

Part II: Operating Systems and Applications

97

Chapter 4: Windows Security 99

Windows Security at the Heart of the Defense	101
Who would target me?	101
Be afraid	102
Microsoft recommendations	103
Out-of-the-Box Operating System Hardening	105
Prior to system hardening	105
The general process of system hardening	105
Windows 2003 new installation example	107
Specifics of system hardening	110
Securing the typical Windows business workstation	114
Securing the typical Windows gaming system	114
Installing Applications	115
Antivirus protection	116
Personal firewalls	118
Secure Shell	118
Secure FTP	119
Pretty Good Privacy	119
Putting the Workstation on the Network	120
Test the hardened workstation	120
Physical security	120
Architecture	120
Firewall	121
Intrusion detection systems	122
Operating Windows Safely	122
Separate risky behavior	122
Physical security issues	124
Configuration issues	125
Configuration control	127
Operating issues	130
Upgrades and Patches	138
Keep current with Microsoft upgrades and patches	138
Keep current with application upgrades and patches	139
Keep current with antivirus signatures	139
Use the most modern Windows version	140
Maintain and Test the Security	140
Scan for vulnerabilities	141
Test questionable applications	141
Be sensitive to the performance of the system	141
Replace old Windows systems	142
Periodically re-evaluate and rebuild	142
Monitoring	143
Logging and auditing	144

Clean up the system	144
Prepare for the eventual attack	145
Attacks Against the Windows Workstation	145
Viruses	145
Worms	146
Trojan horses	147
Spyware and ad support	148
Spyware and “Big Brother”	149
Physical attacks	149
TEMPEST attacks	150
Backdoors	150
Denial-of-service attacks	151
File extensions	151
Packet sniffing	152
Hijacking and session replay	152
Social engineering	152
Summary	153
Chapter 5: UNIX and Linux Security	155
The Focus of UNIX/Linux Security	155
UNIX as a target	155
UNIX/Linux as a poor target	157
Open source issues	158
Physical Security	160
Limiting access	161
Detecting hardware changes	162
Disk partitioning	163
Prepare for the eventual attack	164
Controlling the Configuration	166
Installed packages	166
Kernel configurations	167
Operating UNIX Safely	174
Controlling processes	174
Controlling users	187
Encryption and certificates	194
Hardening UNIX	196
Configuration items	196
TCP wrapper	198
Checking strong passwords	198
Packet filtering with iptables	199
Summary	200
Chapter 6: Web Browser and Client Security	201
Web Browser and Client Risk	201
Privacy versus security	202
Web browser convenience	202

Web browser productivity and popularity	202
Web browser evolution	203
Web browser risks	204
Issues working against the attacker	205
How a Web Browser Works	205
HTTP, the browser protocol	205
Cookies	208
Maintaining state	210
Caching	212
Secure Socket Layer	212
Web Browser Attacks	216
Hijacking attack	216
Replay attack	217
Browser parasites	218
Operating Safely	219
Keeping current with patches	220
Avoiding viruses	220
Using secure sites	220
Securing the network environment	222
Using a secure proxy	223
Avoid using private data	223
General recommendations	224
Web Browser Configurations	225
Cookies	225
Plugins	226
Netscape-specific issues	230
Internet Explorer-specific issues	231
Summary	236
Chapter 7: Web Security	237
What Is HTTP?	237
How Does HTTP Work?	239
HTTP implementation	242
Persistent connections	244
The client/server model	248
Put	249
Get	250
Burstable TCP	250
HTML	251
Server Content	252
CGI scripts	252
PHP pages	253
Client Content	254
JavaScript	254
Java	255
ActiveX	257

State	260
What is state?	260
How does it relate to HTTP?	260
What applications need state?	260
Tracking state	261
Cookies	261
Web bugs	264
URL tracking	265
Hidden frames	265
Hidden fields	266
Attacking Web Servers	266
Account harvesting	266
SQL injection	267
E-commerce Design	269
Physical location	269
Summary	271

Chapter 8: E-mail Security 273

The E-mail Risk	273
Data vulnerabilities	273
Simple e-mail versus collaboration	274
Spam	285
Maintaining e-mail confidentiality	288
Maintaining e-mail integrity	289
E-mail availability issues	290
The E-mail Protocols	290
SMTP	290
POP	294
IMAP	295
E-mail Authentication	296
Plain login	296
Login authentication	297
APOP	297
NTLM/SPA	298
+OK logged onPOP before SMTP	299
Kerberos and GSSAPI	299
Operating Safely When Using E-mail	300
Be paranoid	300
Mail client configurations	301
Application versions	302
Architectural considerations	302
SSH tunnel	303
PGP and GPG	307
Summary	308

Chapter 9: Domain Name System	309
Purpose of DNS	310
Forward lookups	315
Reverse lookups	316
Alternative Approaches to Name Resolution	318
Security Issues with DNS	319
Misconfigurations	321
Zone transfers	322
Predictable query IDs	325
Recursion and iterative queries	325
DNS Attacks	326
Simple DNS attack	327
Cache poisoning	327
Designing DNS	329
Split DNS	329
Split-split DNS	329
Master Slave DNS	331
Detailed DNS Architecture	331
Summary	332
Chapter 10: Server Security	333
General Server Risks	333
Security by Design	334
Maintain a security mindset	335
Establishing a secure development environment	340
Secure development practices	344
Test, test, test	351
Operating Servers Safely	354
Controlling the server configuration	354
Controlling users and access	356
Passwords	357
Monitoring, auditing, and logging	357
Server Applications	358
Data sharing	358
Peer to peer	362
Instant messaging and chat	363
Summary	364

Part III: Network Security Fundamentals

365

Chapter 11: Network Protocols	367
Protocols	367
The Open Systems Interconnect Model	368

The OSI Layers	369
The Application layer	369
The Presentation layer	370
The Session Layer	370
The Transport layer	371
The Network layer	372
The Data Link layer	373
The Physical layer	374
The TCP/IP Model	375
TCP/IP Model Layers	377
Network Address Translation	379
Summary	379
Chapter 12: Wireless Security	381
Electromagnetic Spectrum	381
The Cellular Phone Network	383
Placing a Cellular Telephone Call	385
Wireless Transmission Systems	386
Time Division Multiple Access	386
Frequency Division Multiple Access	386
Code Division Multiple Access	387
Wireless transmission system types	388
Pervasive Wireless Data Network Technologies	393
Spread spectrum	393
Spread spectrum basics	393
IEEE Wireless LAN Specifications	397
The PHY layer	398
The MAC layer	398
IEEE 802.11 Wireless Security	400
WEP	400
WEP security upgrades	402
802.11i	408
Bluetooth	413
Wireless Application Protocol	414
Summary	416
Chapter 13: Network Architecture Fundamentals	417
Network Segments	418
Public networks	418
Semi-private networks	418
Private networks	419
Perimeter Defense	419
Network Address Translation	420
Basic Architecture Issues	422
Subnetting, Switching, and VLANs	424
Address Resolution Protocol and Media Access Control Addresses	426

Dynamic Host Configuration Protocol and Addressing Control	428
Firewalls	429
Packet filtering firewalls	430
Stateful packet filtering	432
Proxy firewalls	433
Disadvantages of firewalls	434
Intrusion Detection Systems	435
Types of intrusion detection systems	436
Methods and modes of intrusion detection	439
Responses to Intrusion Detection	442
Common Attacks	442
Summary	444

Part IV: Communications

445

Chapter 14: Secret Communication 447

General Terms	448
Historic Cryptography	449
Substitution ciphers	449
Ciphers that shaped history	455
The Four Cryptographic Primitives	455
Random number generation	456
Cast Introduction	460
Symmetric Encryption	460
Stream ciphers	462
Block ciphers	463
Sharing keys	465
Asymmetric Encryption (Two-Key Encryption)	467
Using a Certificate Authority	468
Using a web of trust	469
Digital signatures	470
Hash functions	471
Keyed hash functions	473
Putting These Primitives Together to Achieve CIA	473
The Difference Between Algorithm and Implementation	475
Proprietary Versus Open Source Algorithms	476
Summary	477

Chapter 15: Covert Communication 479

Where Hidden Data Hides	479
Where Did It Come From?	481
Where Is It Going?	482
Overview of Steganography	482
Why do we need steganography?	483
Pros of steganography	484

Cons of steganography	485
Comparison to other technologies	485
History of Steganography	488
Using steganography in the fight for the Roman Empire	488
Steganography during war	489
Core Areas of Network Security and Their Relation to Steganography	490
Confidentiality	490
Integrity	491
Availability	491
Additional goals of steganography	491
Principles of Steganography	492
Steganography Compared to Cryptography	493
Protecting your ring example	493
Putting all of the pieces together	494
Types of Steganography	495
Original classification scheme	496
New classification scheme	497
Color tables	501
Products That Implement Steganography	503
S-Tools	503
Hide and Seek	506
Jsteg	508
EZ-Stego	511
Image Hide	512
Digital Picture Envelope	514
Camouflage	516
Gif Shuffle	517
Spam Mimic	519
Steganography Versus Digital Watermarking	520
What is digital watermarking?	521
Why do we need digital watermarking?	521
Properties of digital watermarking	521
Types of Digital Watermarking	522
Invisible watermarking	522
Visible watermarking	523
Goals of Digital Watermarking	523
Digital Watermarking and Stego	524
Uses of digital watermarking	524
Removing digital watermarks	526
Summary	526
Chapter 16: Applications of Secure/Covert Communication	529
E-mail	530
POP/IMAP protocols	530
Pretty Good Privacy	531
Kerberos	532
Authentication Servers	534

Working Model	535
Public Key Infrastructure	537
Public and private keys	538
Key management	540
Web of trust	541
Virtual Private Networks	541
Design issues	543
IPSec-based VPN	544
IPsec header modes	545
PPTP/PPP-based VPNs	547
Secure Shell	548
Secure Sockets Layer/Transport Layer Security	549
SSL Handshake	550
Summary	554

Part V: The Security Threat and the Response 555

Chapter 17: Intrusion Detection and Response 557

Malicious Code	557
Viruses	557
Review of Common Attacks	559
Denial-of-service/Distributed denial-of-service attacks	559
Back door	560
Spoofing	560
Man-in-the-middle	561
Replay	561
TCP/Hijacking	561
Fragmentation attacks	562
Weak keys	562
Mathematical attacks	563
Social engineering	563
Port scanning	564
Dumpster diving	564
Birthday attacks	564
Password guessing	565
Software exploitation	565
Inappropriate system use	566
Eavesdropping	566
War driving	567
TCP sequence number attacks	567
War dialing/demon dialing attacks	567
Intrusion Detection Mechanisms	567
Antivirus approaches	567
Intrusion detection and response	568
IDS issues	571

Honeypots	573
Purposes	573
Honeypot categories	574
When to use a honeypot	575
When not to use a honeypot	575
Current solutions	576
Honeynet Project	577
Incident Handling	577
CERT/CC practices	578
Internet Engineering Task Force guidance	583
Layered security and IDS	584
Computer Security and Incident Response Teams	585
Security Incident Notification Process	587
Automated notice and recovery mechanisms	588
Summary	589

Chapter 18: Security Assessments, Testing, and Evaluation 591

Information Assurance Approaches and Methodologies	591
The Systems Security Engineering Capability Maturity Model	592
NSA Infosec Assessment Methodology	594
Operationally Critical Threat, Asset, and Vulnerability Evaluation	595
Federal Information Technology Security Assessment Framework	595
Certification and Accreditation	596
The National Information Assurance Certification and Accreditation Process	596
Four phases of NIACAP	597
DoD Information Technology Security Certification and Accreditation Process	598
The four phases of DITSCAP	599
Federal Information Processing Standard 102	600
OMB Circular A-130	601
The National Institute of Standards and Technology Assessment Guidelines	602
SP 800-14	603
SP 800-27	604
SP 800-30	604
SP 800-64	606
Penetration Testing	607
Internal penetration test	608
External penetration test	609
Full knowledge test	609
Partial knowledge test	609
Zero knowledge test	609

Closed-box test	610
Open-box test	610
Auditing and Monitoring	610
Auditing	610
Monitoring	611
Summary	612
Chapter 19: Putting Everything Together	613
Critical Problems Facing Organizations	613
How do I convince management security is a problem and that they should spend money on it?	613
How do I keep up with the increased number of attacks?	615
How do you make employees part of the solution and not part of the problem?	615
How do you analyze all of the log data?	616
How do I keep up with all of the different systems across my enterprise and make sure they are all secure?	617
How do I know if I am a target of corporate espionage or some other threat?	617
Top 10 common mistakes	618
General Tips for Protecting a Site	620
Defense in depth	620
Principle of least privilege	621
Know what is running on your system	621
Prevention is ideal but detection is a must	622
Apply and test patches	623
Regular checks of systems	623
Summary	623
Index	625

Acknowledgments

John Wiley is a wonderful publisher to work with. Carol Long is an insightful and energetic executive editor who provides continual support. Marcia Ellett provided constant guidance and expertise, and without all of her help and hard work, this book would not be where it is today.

As deadlines approach you reach out to your co-workers who are truly friends to tap into the expertise and knowledge. Sandy Ring, Bill Speirs, and Vignesh Kumar all wrote or helped write chapters in the book. Their technical knowledge is top notch and their input was critical to the success of the book.

The authors would not be working together or be able to complete the book without having the opportunity to work for such a great company, TSGI (The Sytex Group, Inc.). Continuing thanks to Syd Martin for understanding the importance of research and for allowing creative minds to think of solutions to complex technical problems. Syd's support is critical to the success of this book and the success of the cutting-edge research the team produces.

Most of all we want to thank God for blessing us with a great life and a wonderful family.

Eric has Kerry, who is a loving and supportive wife. Without her none of this would be possible. Eric's wonderful son, Jackson, and his princess, Anna, bring joy and happiness to him everyday.

Ron is blessed with an understanding and supporting wife; children, Sheri and Lisa; and wonderful grandchildren, Patrick, Ryan, Aaron, and Emma.

Jim receives unlimited love and support from his lovely wife, Jill, and his exceptional children, Matthew and Andrew.

In addition, we thank all of our friends, family, and co-workers who have supported us in a variety of ways through this entire process.

Introduction

Network security spans a large number of disciplines, ranging from management and policy topics to operating system kernel fundamentals. Historically, the coverage of these and the other network security areas was presented in multiple, specialized publications or given a high-level treatment that was not suited to the practitioner. *Network Security Bible* approaches network security from the view of the individual who wants to learn and apply the associated network security best practices without having to sort through a myriad of extraneous material from multiple sources. The information provided in this text includes “secrets” learned by practicing professionals in the field of network security through many years of real-world experience.

The Goal of This Book

Network Security Bible provides comprehensive coverage of the fundamental concepts of network security and the processes and means required to implement a secure network. The goal of this text is to provide the reader with an understanding of security engineering processes and network security best practices, including in-depth specifics on the following topics:

- ◆ Windows
- ◆ UNIX
- ◆ Linux
- ◆ The World Wide Web
- ◆ E-mail
- ◆ Risk management
- ◆ Server applications
- ◆ Domain Name Systems (DNS)
- ◆ Communications security

Other topics are aimed at providing the reader with insight into information assurance through clear and thorough tutorials on the latest information, including security assessment, evaluation, and testing techniques. This up-to-date and applicable knowledge will benefit practitioners in the commercial, government, and industrial sectors.

Network Security Bible meets the needs of information security professionals and other individuals who have to deal with network security in their everyday activities. It is truly an all-inclusive reference that tells you why and how to achieve a secure network in clear and concise terms.

The Five Parts of This Book

Network Security Bible is organized into the following five parts:

- ◆ **Part I:** Security Principles and Practices
- ◆ **Part II:** Operating Systems and Applications
- ◆ **Part III:** Network Security Fundamentals
- ◆ **Part IV:** Communications
- ◆ **Part V:** The Security Threat and Response

The flow of the material is designed to provide a smooth transition from fundamental principles and basic knowledge to the practical details of network security. In this manner, the text can serve as a learning mechanism for people new to the field as well as a valuable reference and guide for experienced professionals.

Part I: Security Principles and Practices

Part I provides a background in the fundamentals of information system security. Specifically, it comprises chapters on information system security principles, information system security management, and access control.

- ◆ **Chapter 1: Information System Security Principles.** It is important that the network security practitioner be intimately familiar with the fundamental tenets of information system security, particularly the concepts of confidentiality, integrity, and availability (CIA). These topics are explained in detail in this chapter and then related to threats, vulnerabilities, and possible impacts of threats realized. After covering these basic topics, the formal processes of systems engineering (SE), information systems security engineering (ISSE), the systems development life cycle (SDLC), and the relationship of network security to the SDLC are explained. These subject areas provide the reader with an excellent understanding of applying standard rules to incorporate information system security into system development activities. These skills are particularly valuable to individuals working in large companies that need the discipline provided by these methods and to government organizations required to apply formal information security approaches in their everyday operations.

- ◆ **Chapter 2: Information System Security Management.** To continue to provide a basis for delving into network security issues, this chapter discusses the important, but sometimes neglected, roles of management and administration in implementing good network security. All personnel in an organization should be aware of the information security policies, procedures, and guidelines and practice them on an ongoing basis. The existence of these documents and practices are of critical importance to an organization and should be incorporated into the organization's routine operations. For example, the seemingly innocuous requirement of requiring critical personnel to take vacation time in blocks of a week or more might reveal covert and illegal activities on the part of those individuals when they are replaced by new personnel during the vacation interval. Also, corporate officers will be exposed to legal liability if they do not have policies in place addressing the protection of the organization's intellectual property and other critical information.

Chapter 2 also provides clear and concise guidelines on the best practices to ensure the continuity of an organization's critical operations during and after a disaster. Business continuity planning (BCP) and disaster recover planning (DRP) approaches are explained and illustrated, providing for continuity of critical business functions and networked information systems, respectively.

- ◆ **Chapter 3: Access Control Considerations.** Controlling access to critical network and computer resources is one of the most important requirements for any organization. Chapter 4 defines and illustrates the concepts of identifying a user or process to an information system, verifying the identity of that user or process (authentication), and granting access privileges to specific resources (authorization). In addition, this chapter covers the methods of implementing secure access to information systems from remote sites.

Part II: Operating Systems and Applications

In the second part of this book, the security issues and solutions associated with operating systems such as Windows, UNIX, and Linux are detailed. Following these topics, Web browser security, Web security, e-mail security, domain name systems, and server applications are addressed. The authors provide insights and directions to implementing operating system and Web security based on their extensive experience in these areas.

- ◆ **Chapter 4: Windows Security.** Because the many versions of the Windows operating system that are in widespread use, their security vulnerabilities pose serious threats to their host computers. Chapter 4 reviews these security problems and offers steps to be taken to securely install Windows, harden the operating system, operate securely, and maintain a safe system.
- ◆ **Chapter 5: UNIX and Linux Security.** UNIX and the open source Linux operating systems are becoming increasingly popular as counters to the reliability problems of the Windows operating systems. Thus, network security aspects

of UNIX and Linux are covered in Chapter 5, including kernel issues, extraneous services, and specific services such as NFS, Sendmail, BIND, and RIP.

- ◆ **Chapter 6: Web Browser and Client Security.** Web browsers pose serious threats to the security of their host machines and this chapter explores the sources of those threats, focusing on the Netscape and Internet Explorer browsers. The authors provide their solutions to securing a Web browser and protecting corporate portals.
- ◆ **Chapter 7: Web Security.** Building on the information and solutions presented for Web browsers, Chapter 7 continues by examining the Hypertext Transfer Protocol (HTTP); Common Gateway Interface (CGI) security issues; privacy concerns associated with cookies, hidden fields and URL tracking; auditing; and the secure implementation of e-commerce applications.
- ◆ **Chapter 8: E-mail Security.** Because we all use e-mail, the information security knowledge covered in this chapter is directly applicable to users, IT professionals, and security personnel. Chapter 8 explains the different types of e-mail, including SMTP, POP3, and IMAP. The authors describe how to properly configure e-mail systems, and how to handle security problems associated with those types.
- ◆ **Chapter 9: Domain Name System.** This chapter describes the concepts behind the Domain Name System (DNS), Master and Slave Name servers, and the design of Domain Name Systems, including split DNS and split-split DNS. The authors then describe how to set up different types of DNS servers and discuss recursion and zone transfers.
- ◆ **Chapter 10: Server Security.** Another key knowledge component of network security is understanding the different types of servers and their associated applications. Chapter 10 describes the general principles to be observed when putting a server on line and then specifically presents valuable commentary on FTP servers, instant messaging, NetBIOS file sharing, secure shell, Kazaa, and remote access of computer-based information.

Part III: Network Security Fundamentals

This part describes the various network protocols, particularly the specifics of the OSI and TCP models. The fundamental concepts of wireless communication and wireless security are explained, including coding schemes, the different wireless technology generations, and wireless vulnerabilities. The authors then provide detailed recommendations and guidance for securing networks along with descriptions of the components of network architectures.

- ◆ **Chapter 11: Network Protocols.** This chapter explains in detail the OSI and TCP models and the IP, ICMP, TCP, and UDP protocols. It also reviews address resolution concepts and methods and relates them to the general goals of network security.

- ◆ **Chapter 12: Wireless Security.** Wireless connections to the Internet are becoming extremely popular and this chapter covers topics including the wireless frequency spectrum, fundamentals of wireless transmission, the different coding schemes and generations of wireless technology, and security issues associated with wireless applications.
- ◆ **Chapter 13: Network Architecture Fundamentals.** The components of a network and their corresponding configurations for implementing security are critical factors in the protection information systems. Chapter 14 provides clear descriptions and explanations of network bridges, routers, switches, firewalls, gateways, guards, and other important network elements. Their functions and relationship to the overall security of a network are reviewed and guidelines for their application are provided.

Part IV: Communications

Part IV of this book reveals the best practices and approaches related to communications security.

- ◆ **Chapter 14: Secret Communication.** Secret communication involves the means to encrypt and decrypt messages as well as to authenticate the sender. Chapter 14 provides a history of cryptography, reviews the fundamentals of symmetric and asymmetric encryption, explains digital signatures, and concludes with an overview of generally accepted cryptographic axioms.
- ◆ **Chapter 15: Covert Communication.** Covert communication refers to communication that conceals the fact that hidden information is being transmitted. In secret communication, described in Chapter 14, an attacker is aware that sensitive information is being transmitted in scrambled form. The problem for the attacker is to retrieve the information by unscrambling or decrypting it. In covert communication, sensitive information might be hidden somewhere in an image or in a microdot that appears as a period at the end of a sentence. Thus, an attacker does not know that information is hidden unless he or she checks everything that is being transmitted for concealed messages. This type of covert communication is known as steganography. Chapter 15 describes the goals of steganography, its advantages and disadvantages, methods of embedding sensitive information in other components such as images, and tools for detecting hidden information.
- ◆ **Chapter 16: Applications of Secure/Covert Communication.** Chapter 16 details the methods of achieving secure and covert communication. The topics addressed include e-mail security, implementing virtual private networks (VPNs), and applying different protocols to protect information transmitted over the Internet. The chapter also addresses digital certificates to “certify” individuals’ public keys and methods of managing cryptographic keys in an organizational setting.

Part V: The Security Threat and Response

The chapters in this part primarily address the issues of detecting and responding to network intrusions and assuring the security controls that have been put in place actually do provide the expected results. This section and the text conclude with “putting everything together” through detailed descriptions of the most common problems in network security, their solutions, and planning for future situations.

- ◆ **Chapter 17: Intrusion Detection and Response.** The network security practitioner has to be familiar with and understand the various types and effects of malicious code. Chapter 17 explains these different kinds of malware, discusses common types and sources of attacks, and shows how to detect and handle intrusions into a network and its resources.
- ◆ **Chapter 18: Security Assessments, Testing, and Evaluation.** Private and governmental organizations, by necessity, have to ensure that their networks and information systems are secure from attacks. Both entities have critical and sensitive information that have to be protected from violations of confidentiality, integrity, and availability. Therefore, these organizations have developed assessment and evaluation approaches that can be applied to determine whether a network is really secure, even after appropriate controls have been implemented. Chapter 18 discusses these methodologies, including the Systems Security Engineering Capability Maturity Model (SSE-CMM), the different types of certification and accreditation approaches, the National Institute for Standards and Technology (NIST) information security publications, and the various types of testing and auditing practices.
- ◆ **Chapter 19: Putting Everything Together.** At this point in *Network Security Bible*, the elements that comprise a network, security architectures, security threats, countermeasures, incident handling, and assessment approaches have been covered in detail. Chapter 19 ties all these entities together by describing the top 10 problems of network security, the top 10 solutions to these problems, the top 10 mistakes information security and IT practitioners make, and how to develop a framework for future activities and challenges.

How to Use This Book

Network Security Bible is designed for use as a comprehensive tutorial on the field of network security, as a “how to” manual for implementing network security, as a reference document for the information and network security practitioner, and as a guide for planning future network security issues and projects.

Use as a comprehensive tutorial on the field of network security

Network Security Bible is organized to provide the reader with an understanding of the fundamentals of information system security by covering their basic principles, standard processes, management issues, and access control concepts. With this foundation, the text expands into discussions of the popular operating systems, Internet security, and Web security. Following this material, a tutorial on networking protocols, wireless communications, and network architectures provides an understanding of networking and communications. The book then explores the fundamentals of intrusion detection and information security assessment methodologies. All these topics comprise book parts so that the reader can focus on the areas of particular interest to him or her and scan or skip topics that are familiar. Thus, the book is designed to provide either a comprehensive or selective tutorial, based on the experience and training of the reader.

Use as a “how to” manual for implementing network security

The authors of this text have extensive experience in analyzing network security problems and implementing effective solutions. Based on this experience, the authors provide guidance and detail “secrets” used by real-world practitioners to solve real-world problems. These “secrets” apply to the following areas:

- ◆ Risk management
- ◆ Information security system life cycle processes
- ◆ Training
- ◆ Business continuity/disaster recovery
- ◆ Back-ups
- ◆ Remote authentication
- ◆ Windows
- ◆ UNIX
- ◆ Linux
- ◆ Attacks
- ◆ E-mail
- ◆ Server security
- ◆ Wireless security
- ◆ Intrusion detection and handling
- ◆ Assurance evaluation

Use as a reference document for the information and network security practitioner

The chapters of *Network Security Bible* contain fundamental and advanced knowledge on network security and related topics. This content will serve as a useful reference source for the information security practitioner in conducting his or her everyday security-related activities. The chapters on operating systems, access control, wireless security, Web security, intrusion detection and response, and assessment methodologies will be particularly useful in present and future applications.

Use as a guide for planning future network security issues and projects

The book emphasizes topics that are focused on planning for the future and anticipating network security problems and issues. These topics address the following relevant and important areas:

- ◆ How to apply good systems engineering principles to the development of information security systems
- ◆ Recommendations concerning which standards and guidelines are most useful and that should be used in implementing and achieving required network security
- ◆ How to implement organizational security policies and how to ensure that they are understood and institutionalized
- ◆ How to make sure that the organization is prepared for a disaster
- ◆ How to protect against possible future liability suits
- ◆ How to plan for expanded, secure, remote access requirements
- ◆ How to implement wireless security
- ◆ How to protect against future attacks
- ◆ How to handle future attacks
- ◆ How to assess the effectiveness of proposed new security architectures

These issues and approaches are then summarized in the last chapter.

Security Principles and Practices

P A R T



In This Part

Chapter 1

Information System
Security Principles

Chapter 2

Information System
Security Management

Chapter 3

Access Control
Considerations



Information System Security Principles

A number of organizations have defined terminology and methodologies for applying systems engineering (SE) principles to large tasks and undertakings. When information systems and networks are involved, companion Information System Security Engineering (ISSE) processes should be practiced concurrently with SE at project initiation.

This chapter defines the fundamental principles of network security and explains the SE and ISSE processes. It also describes the steps in the systems development life cycle (SDLC) and reviews how network and information technology (IT) security practices can be incorporated into the SDLC activities.

The chapter concludes with coverage of risk management techniques and the application of risk management in the SDLC.

Key Principles of Network Security

Network security revolves around the three key principles of confidentiality, integrity, and availability (C-I-A). Depending upon the application and context, one of these principles might be more important than the others. For example, a government agency would encrypt an electronically transmitted classified document to prevent an unauthorized person from reading its contents. Thus, confidentiality of the information is paramount. If an individual succeeds in breaking the encryption cipher and, then, retransmits a modified encrypted version, the integrity of the message is compromised. On the

CHAPTER



In This Chapter

Reviewing the principles of network security

Understanding the systems engineering and Information Systems Security Engineering process

Summarizing the System Development Life Cycle (SDLC)

Relating information systems security and the SDLC

Managing risk



other hand, an organization such as Amazon.com would be severely damaged if its network were out of commission for an extended period of time. Thus, availability is a key concern of such e-commerce companies.

Confidentiality

Confidentiality is concerned with preventing the unauthorized disclosure of sensitive information. The disclosure could be intentional, such as breaking a cipher and reading the information, or it could be unintentional, due to carelessness or incompetence of individuals handling the information.

Integrity

There are three goals of integrity:

- ♦ Prevention of the modification of information by unauthorized users
- ♦ Prevention of the unauthorized or unintentional modification of information by authorized users
- ♦ Preservation of the internal and external consistency
 - Internal consistency ensures that internal data is consistent. For example, in an organizational database, the total number of items owned by an organization must equal the sum of the same items shown in the database as being held by each element of the organization.
 - External consistency ensures that the data stored in the database is consistent with the real world. Relative to the previous example, the total number of items physically sitting on the shelf must equal the total number of items indicated by the database.

Availability

Availability assures that a system's authorized users have timely and uninterrupted access to the information in the system and to the network.

Other important terms

Also important to network security are the following four C-I-A-related terms:

- ♦ **Identification** — The act of a user professing an identity to the system, such as a logon ID
- ♦ **Authentication** — Verification that the user's claimed identity is valid, such as through the use of a password

- ♦ **Accountability**—Determination of the actions and behavior of a single individual within a system, and holding the individual responsible for his or her actions
- ♦ **Authorization**—The privileges allocated to an individual (or process) that enable access to a computer resource

Formal Processes

The processes associated with specifying, designing, implementing, operating, and maintaining network-based systems are amenable to formal methods. These methods provide a structured approach to achieving effective and maintainable networks and systems. In particular, applying the disciplines of systems engineering and systems security engineering (SSE) in the systems development life cycle can yield functional, secure, robust, and cost-effective networks and systems. These processes are described in the following sections.

The systems engineering process

There are a myriad of definitions of systems engineering, ranging from the view of government and military establishments to commercial organizations. A sampling of these definitions follows:

- ♦ “The function of systems engineering is to guide the engineering of complex systems. ... A system is a set of interrelated components working together toward some common objective.” (Kossiakoff and Sweet, *Systems Engineering, Principles and Practices*, John Wiley & Sons, 2003.)
- ♦ The branch of engineering concerned with the development of large and complex systems, where a system is understood to be an assembly or combination of interrelated elements or parts working together toward a common objective. (General, widely used definition)
- ♦ The selective application of scientific and engineering efforts to:
 - Transform an operational need into a description of the system configuration which best satisfies the operational need according to the measures of effectiveness
 - Integrate related technical parameters and ensure compatibility of all physical, functional, and technical program interfaces in a manner that optimizes the total system definition and design
 - Integrate the efforts of all engineering disciplines and specialties into the total engineering effort

(From the Carnegie Mellon Software Engineering Institute (SEI) “Systems Engineering Capability Model” [SE-CMM-95-01]” document, version 1.1.)

- ♦ Systems engineering integrates all the disciplines and specialty groups into a team effort forming a structured development process that proceeds from concept to production to operation. Systems engineering considers both the business and the technical needs of all customers with the goal of providing a quality product that meets the user needs. (The International Council on Systems Engineering [INCOSE], www.incose.org.)
- ♦ A process that will:
 - Transform approved operational needs and requirements into an integrated system design solution through concurrent consideration of all life-cycle needs (that is, development, manufacturing, testing and evaluation, deployment, operations, support, training, and disposal).
 - Ensure the interoperability and integration of all operational, functional, and physical interfaces. Ensure that system definition and design reflect the requirements for all system elements: hardware, software, facilities, people, and data.
 - Characterize and manage technical risks.
 - Apply scientific and engineering principles, using the system security engineering process, to identify security vulnerabilities and minimize or contain information assurance and force protection risks associated with these vulnerabilities. (DoD regulation 5000.2-R, April 5, 2002.)

The Information Assurance Technical Framework

The Information Assurance Technical Framework Forum (IATFF) is an organization sponsored by the National Security Agency (NSA) and supports technical interchanges among U.S. industry, U.S. academic institutions, and U.S. government agencies on the topic of information assurance. The Forum generated the Information Assurance Technical Framework (IATF) document, release 3.1, which describes processes and provides guidance for the protection of information systems based on systems engineering principles (www.iatf.net/framework_docs/version-3_1/). The document emphasizes the criticality of the *people* involved, the *operations* required, and the *technology* needed to meet the organization's mission. These three entities are the basis for the Defense-in-Depth protection methodology described in Chapter 2 of IATF Document, release 3.1. The principles of Defense-in-Depth are presented in the next section.

Defense-in-Depth

Defense-in-Depth is a layered protection scheme for critical information system components. The Defense-in-Depth strategy comprises the following areas:

- ♦ Defending the network and infrastructure
- ♦ Defending the enclave boundary

- ♦ Defending the computing environment
- ♦ Supporting Infrastructures

The term *enclave* as used in the Defense-in-Depth protection strategy refers to a “collection of computing environments connected by one or more internal networks under the control of a single authority and security policy, including personnel and physical security. Enclaves always assume the highest mission assurance category and security classification of the automated information system (AIS) applications or outsourced IT-based processes they support, and derive their security needs from those systems. They provide standard information assurance (IA) capabilities such as boundary defense, incident detection and response, and key management, and also deliver common applications such as office automation and electronic mail. Enclaves are analogous to general support systems as defined in OMB A-130. Enclaves may be specific to an organization or a mission, and the computing environments may be organized by physical proximity or by function independent of location. Examples of enclaves include local area networks (LANs) and the applications they host, backbone networks, and data processing centers.” (DoD Directive 8500.1, “Information Assurance (IA), October 24, 2002). The enclaves in the U.S. federal and defense computing environments can be categorized as public, private, or classified.

The Defense-in-Depth strategy is built on three critical elements: people, technology, and operations.

People

To implement effective information assurance in an organization, management must have a high-level commitment to the process. This commitment is manifested through the following items and activities:

- ♦ Development of information assurance policies and procedures
- ♦ Assignment of roles and responsibilities
- ♦ Training of critical personnel
- ♦ Enforcement of personal accountability
- ♦ Commitment of resources
- ♦ Establishment of physical security controls
- ♦ Establishment of personnel security controls
- ♦ Penalties associated with unauthorized behavior

Technology

An organization has to ensure that the proper technologies are acquired and deployed to implement the required information protection services. These

objectives are accomplished through the following processes and policies for the acquisition of technology:

- ♦ A security policy
- ♦ System-level information assurance architectures
- ♦ System-level information assurance standards
- ♦ Information assurance principles
- ♦ Specification criteria for the required information assurance products
- ♦ Acquisition of reliable, third-party, validated products
- ♦ Configuration recommendations
- ♦ Risk assessment processes for the integrated systems

Operations

Operations emphasize the activities and items necessary to maintain an organization's effective security posture on a day-to-day basis. These activities and items include the following:

- ♦ A visible and up-to-date security policy
- ♦ Enforcement of the information security policy
- ♦ Certification and accreditation
- ♦ Information security posture management
- ♦ Key management services
- ♦ Readiness assessments
- ♦ Protection of the infrastructure
- ♦ Performing systems security assessments
- ♦ Monitoring and reacting to threats
- ♦ Attack sensing, warning, and response (ASW&R)
- ♦ Recovery and reconstitution

The Defense-in-Depth strategy is defined to defend against the following types of attacks, as described in IATF document 3.1:

- ♦ **Passive**—Passive attacks include traffic analysis, monitoring of unprotected communications, decrypting weakly encrypted traffic, and capture of authentication information (such as passwords). Passive intercept of network operations can give adversaries indications and warnings of impending actions. Passive

attacks can result in disclosure of information or data files to an attacker without the consent or knowledge of the user. Examples include the disclosure of personal information such as credit card numbers and medical files.

- ♦ **Active**—Active attacks include attempts to circumvent or break protection features, introduce malicious code, or steal or modify information. These attacks may be mounted against a network backbone, exploit information in transit, electronically penetrate an enclave, or attack an authorized remote user during an attempt to connect to an enclave. Active attacks can result in the disclosure or dissemination of data files, denial of service, or modification of data.
- ♦ **Close-in**—Close-in attacks consist of individuals attaining physical proximity to networks, systems, or facilities for the purpose of modifying, gathering, or denying access to information. Close physical proximity is achieved through surreptitious entry, open access, or both.
- ♦ **Insider**—Insider attacks can be malicious or nonmalicious. Malicious insiders intentionally eavesdrop, steal, or damage information; use information in a fraudulent manner; or deny access to other authorized users. Nonmalicious attacks typically result from carelessness, lack of knowledge, or intentional circumvention of security for such reasons as “getting the job done.”
- ♦ **Distribution**—Distribution attacks focus on the malicious modification of hardware or software at the factory or during distribution. These attacks can introduce malicious code into a product, such as a back door to gain unauthorized access to information or a system function at a later date.

To resist these types of attacks, Defense-in-Depth applies the following techniques:

- ♦ **Defense in multiple places**—Deployment of information protection mechanisms at multiple locations to protect against internal and external threats.
- ♦ **Layered defenses**—Deployment of multiple information protection and detection mechanisms so that an adversary or threat will have to negotiate multiple barriers to gain access to critical information.
- ♦ **Security robustness**—Based on the value of the information system component to be protected and the anticipated threats, estimation of the robustness of each information assurance components. Robustness is measured in terms of assurance and strength of the information assurance component.
- ♦ **Deploy KMI/PKI**—Deployment of robust key management infrastructures (KMI) and public key infrastructures (PKI).
- ♦ **Deploy intrusion detection systems**—Deployment of intrusion detection mechanisms to detect intrusions, evaluate information, examine results, and, if necessary, to take action.

Implementing the Defense-in-Depth approach can be resource intensive. To assist in the cost-effective implementation of Defense-in-Depth, IATF document 3.1 provides the following guidelines:

- ♦ Make information assurance decisions based on risk analysis and keyed to the organization's operational objectives.
- ♦ Draw from all three facets of Defense-in-Depth — people, operations, and technology. Technical mitigations are of no value without trained people to use them and operational procedures to guide their application.
- ♦ Establish a comprehensive program of education, training, practical experience, and awareness. Professionalization and certification licensing provide a validated and recognized expert cadre of system administrators.
- ♦ Exploit available commercial off-the-shelf (COTS) products and rely on in-house development for those items not otherwise available.
- ♦ Periodically assess the IA posture of the information infrastructure. Technology tools, such as automated scanners for networks, can assist in vulnerability assessments.
- ♦ Take into account, not only the actions of those with hostile intent, but also inadvertent or careless actions.
- ♦ Employ multiple means of threat mitigation, overlapping protection approaches to counter anticipated events so that loss or failure of a single barrier does not compromise the overall information infrastructure.
- ♦ Ensure that only trustworthy personnel have physical access to the system. Methods of providing such assurance include appropriate background investigations, security clearances, credentials, and badges.
- ♦ Use established procedures to report incident information provided by intrusion detection mechanisms to authorities and specialized analysis and response centers.

Systems engineering processes

A number of paradigms are applicable to implementing systems engineering and some useful approaches are listed here:

- ♦ IEEE STD 1220-1998 processes:
 - Requirements Analysis
 - Requirements Verification
 - Functional Analysis
 - Functional Verification
 - Synthesis
 - Design Verification

- ◆ DoD 5000.2-R processes:
 - Requirements Analysis
 - Functional Analysis/Allocation
 - Synthesis

A commonly used set of processes in the U.S. government is described in IATF document 3.1, and this set is the basis for deriving information system security engineering (ISSE) processes. These “generic” SE processes are as follows:

- ◆ Discover needs
- ◆ Define system requirements
- ◆ Design system architecture
- ◆ Develop detailed design
- ◆ Implement system
- ◆ Assess effectiveness

These processes emphasize the application of SE over the entire development life cycle.

The Information Systems Security Engineering process

The ISSE processes are based on the generic SE processes, as shown in the following pairings:

- ◆ Discover information protection needs — Discover needs
- ◆ Define system security requirements — Define system requirements
- ◆ Design system security architecture — Design system architecture
- ◆ Develop detailed security design — Develop detailed design
- ◆ Implement system security — Implement system
- ◆ Assess information protection effectiveness — Assess effectiveness

The six ISSE processes are comprised of the activities (as described in IATF document 3.1) discussed in the following sections.

Discover information protection needs

The objectives of this process are to understand and document the customer’s needs and to develop solutions that will meet these needs. The information systems security engineer should use any reliable sources of information to learn

about the customer's mission and business operations, including areas such as human resources, finance, command and control, engineering, logistics, and research and development. This knowledge can be used to generate a *concept of operations* (CONOPS) document or a *mission needs statement* (MNS). The Committee on National Security Systems (CNSS) Instruction No. 4009, "National Information Assurance (IA) Glossary" defines a CONOPS as "a document detailing the method, act, process, or effect of using an information system (IS).

Then, with this information in hand, an *information management model* (IMM) should be developed that ultimately defines a number of *information domains*. Information management includes the following:

- ♦ Creating information
- ♦ Acquiring information
- ♦ Processing information
- ♦ Storing and retrieving information
- ♦ Transferring information
- ♦ Deleting information

The information management model should take into account information domains that comprise the following items:

- ♦ The information being processed
- ♦ Processes being used
- ♦ Information generators
- ♦ Information consumers
- ♦ User roles
- ♦ Information management policy requirements
- ♦ Regulations
- ♦ Agreements or contracts

The principle of *least privilege* should be used in developing the model by permitting users to access only the information required for them to accomplish their assigned tasks.

Table 1-1 provides an example of an IMM.

Table 1-1
Information Management Model

<i>Users</i>	<i>Rules</i>	<i>Process</i>	<i>Information</i>
CEO	Read	Corporate Finance	Policy
Treasurer	Read/Write	Corporate Finance	Policy
Asst. Treasurer	Read/Write	Corporate Finance	Policy

A similar example of the output domains of the IMM is given in Table 1-2.

Table 1-2
IMM Information Domain Example

<i>Domain</i>	<i>Users</i>	<i>Rules</i>	<i>Process</i>	<i>Information</i>
Human Resources	Director	Read/Write	Corporate Salary Schedule	Job Classifications, Salaries
Human Resources	Benefits Staff	Read	Corporate Salary Schedule	Benefit Plans, Salaries, Employee Contributions

The information systems security engineer must document all elements of the Discover Information Protection Needs activity of the ISSE process, including the following:

- ♦ Roles
- ♦ Responsibilities
- ♦ Threats
- ♦ Strengths
- ♦ Security services
- ♦ Priorities
- ♦ Design constraints

These elements comprise the fundamental concepts of an *Information Protection Policy* (IPP), which in turn becomes a component of the customer's *information management policy* (IMP).

The information systems security engineer must also support the certification and accreditation (C&A) of the system. *Certification* is the comprehensive evaluation of the technical and nontechnical security features of an information system and the other safeguards, which are created in support of the accreditation process, to establish the extent in which a particular design and implementation meets the set of specified security requirements.

Accreditation is the formal declaration by a Designated Approving Authority (DAA) that an information system is approved to operate in a particular security mode by using a prescribed set of safeguards at an acceptable level of risk.

Recertification and *re-accreditation* are required when changes occur in the system or its environment, or after a defined period of time after accreditation.

Define system security requirements

For this activity, the information systems security engineer identifies one or more solution sets that can satisfy the IPP's information protection needs. A solution set consists of the following items:

- ♦ Preliminary security CONOPS
- ♦ The system context
- ♦ The system security requirements

Based on the IP, the information systems security engineer, in collaboration with the customer, chooses the best solution among the solution sets.

The preliminary security CONOPS identifies the following:

- ♦ The information protection functions
- ♦ The information management functions
- ♦ The dependencies among the organization's mission
- ♦ The services provided by other entities

To develop the system context, the information systems security engineer performs the following functions:

- ♦ Uses systems engineering techniques to identify the boundaries of the system to be protected
- ♦ Allocates security functions to the system as well as to external systems by analyzing the flow of data among the system to be protected and the external systems, and using the information compiled in the IPP and IMM.

The information systems security engineer produces the system security requirements, in collaboration with the systems engineers. Requirements should be unambiguous, comprehensive, and concise, and they should be obtained through the process of requirements analysis. The functional requirements and constraints on the design of the information security components include the following:

- ♦ Regulations
- ♦ The operating environment
- ♦ Targeting internal as well as external threats
- ♦ Customer needs

The information systems security engineer must also assess cryptographic needs and systems such as public key infrastructure (PKI).

Finally, the information systems security engineer reviews the security CONOPS, the security context, and the system security requirements with the customer to ensure that they meet the needs of the customer and are accepted by the customer.

Note

An important consideration in the entire process is the generation of appropriate and complete documentation. This documentation will be used to support the C&A process and should be developed to meet the C&A requirements.

Design system security architecture

In this stage, the information systems security engineer performs a *functional decomposition* of the requirements that can be used to select the components required to implement the designated functions. Tools and techniques such as time-line analysis, flow block diagrams, and a requirements allocation sheet are used to accomplish the decomposition. The result of the functional decomposition is the *functional architecture* of the information security system.

In the decomposition process, the performance requirements at the higher level are mapped onto the lower-level functions to ensure that the resulting system performs as required. Also, as part of this activity, the information systems security engineer determines, at a functional level, the security services that should be assigned to the system to be protected as well as to external systems. Such services include encryption, key management, and digital signatures. Because implementations are not specified in this activity, a complete risk analysis is not possible. General risk analysis, however, can be done by estimating the vulnerabilities in the classes of components that are likely to be used.

Develop detailed security design

The detailed security design is accomplished through continuous assessments of risks and the comparison of these risks with the information system security requirements. This design activity involves both the SE and ISSE professionals and specifies the system and components, but does not specify products or vendors.

In conducting this activity, the information systems security engineer performs the following functions:

- ♦ Develops specifications such as Common Criteria protection profiles
- ♦ Maps security mechanisms to system security design elements
- ♦ Catalogs candidate commercial off-the-shelf (COTS) products
- ♦ Catalogs candidate government off-the-shelf (GOTS) products
- ♦ Catalogs custom security products
- ♦ Qualifies external and internal element and system interfaces

The results of this effort should include a revised security CONOPS, identification of failures to meet the security requirements, meeting of the customers design constraints, and placing of the design documents under configuration control.

Implement system security

This activity bridges the design phase and the operational phase. It includes a system effectiveness assessment that provides evidence that the system meets the requirements and needs of the mission. Security accreditation usually follows this assessment.

The information systems security engineer approaches this task by doing the following:

- ♦ Applying information protection assurance mechanisms related to system implementation and testing
- ♦ Verifying that the implemented system does address and protect against the threats itemized in the original threat assessment
- ♦ Providing input to the C&A process
- ♦ Providing input to and reviewing the evolving system life-cycle support plans
- ♦ Providing input to and reviewing the operational procedures
- ♦ Providing input to and reviewing the maintenance training materials
- ♦ Taking part in multidisciplinary examinations of all system issues and concerns

This activity identifies the specific components of the information system security solution. In selecting these components, the information system security engineer must consider the following items:

- ♦ Cost
- ♦ Form factor
- ♦ Reliability

- ♦ Availability now and in the future
- ♦ Risk to system caused by substandard performance
- ♦ Conformance to design specifications
- ♦ Compatibility with existing components
- ♦ Meeting or exceeding evaluation criteria (Typical evaluation criteria include the Commercial COMSEC Evaluation Program [CCEP], National Information Assurance Partnership [NIAP], Federal Information Processing Standards [FIPS], NSA criteria, and NIST criteria.)

In some cases, components might have to be built and customized to meet the requirements if no suitable components are available for purchase or lease.

In addition, the systems and design engineers in cooperation with the information systems security engineer are involved with the following:

- ♦ Developing test procedures to ensure that the designed system performs as required; these procedures should incorporate the following:
 - Test planning, to include facilities, schedule, personnel, tools, and required resources
 - Integration testing
 - Functional testing to ensure that systems and subsystems operate properly
 - Generation of test reports
- ♦ Tests of all interfaces, as feasible
- ♦ Conducting unit testing of components
- ♦ Developing documentation and placing documentation under version control; the documentation should include the following:
 - Installation procedures
 - Operational procedures
 - Support procedures
 - Maintenance procedures
 - Defects discovered in the procedures

Assess information protection effectiveness

This activity, even though listed last, must be conducted as part of all the activities of the complete ISSE and SE processes. Table 1-3 summarizes the tasks of the Assess Information Protection activity that correspond to the other activities of the ISSE process. (Information taken from the IATF document, Release 3.1.)

Table 1-3
Assess Information Protection Effectiveness
Tasks and Corresponding ISSE Activities

<i>ISSE Activity</i>	<i>Assess Information Protection Effectiveness Tasks</i>
Discover information protection needs	<p>Present the process overview.</p> <p>Summarize the information model.</p> <p>Describe threats to the mission or business through information attacks.</p> <p>Establish security services to counter those threats and identify their relative importance to the customer.</p> <p>Obtain customer agreement on the conclusions of this activity as a basis for determining the system security effectiveness.</p>
Define system security requirements	<p>Ensure that the selected solution set meets the mission or business security needs.</p> <p>Coordinate the system boundaries.</p> <p>Present security context, security CONOPS, and system security requirements to the customer and gain customer concurrence.</p> <p>Ensure that the projected security risks are acceptable to the customer.</p>
Design system security architecture	<p>Begin the formal risk analysis process to ensure that the selected security mechanisms provide the required security services, and explain to the customer how the security architecture meets the security requirements.</p>
Develop detailed security design	<p>Review how well the selected security services and mechanisms counter the threats by performing an interdependency analysis to compare desired to actual security service capabilities.</p> <p>Once completed, the risk assessment results, particularly any mitigation needs and residual risk, will be documented and shared with the customer to obtain their concurrence.</p>

<i>ISSE Activity</i>	<i>Assess Information Protection Effectiveness Tasks</i>
Implement system security	<p>The risk analysis will be conducted or updated.</p> <p>Strategies will be developed for the mitigation of identified risks.</p> <p>Identify possible mission impacts and advise the customer and the customer's Certifiers and Accreditors.</p>

As noted previously, there is a one-to-one pairing of the SE and ISSE processes. This pairing is described in the IATF document 3.1 and summarized in Table 1-4.

**Table 1-4
Corresponding SE and ISSE Activities**

<i>SE Activities</i>	<i>ISSE Activities</i>
<p>Discover needs The systems engineer helps the customer understand and document the information management needs that support the business or mission. Statements about information needs may be captured in an information management model (IMM).</p>	<p>Discover information protection needs The information systems security engineer helps the customer understand the information protection needs that support the mission or business. Statements about information protection needs may be captured in an Information Protection Policy (IPP).</p>
<p>Define system requirements The systems engineer allocates identified needs to systems. A system context is developed to identify the system environment and to show the allocation of system functions to that environment. A preliminary system concept of operations (CONOPS) is written to describe operational aspects of the candidate system (or systems). Baseline requirements are established.</p>	<p>Define system security requirements The information systems security engineer allocates information protection needs to systems. A system security context, a preliminary system security CONOPS, and baseline security requirements are developed.</p>

Continued

Table 1-4 (continued)

SE Activities**Design system architecture**

The systems engineer performs functional analysis and allocation by analyzing candidate architectures, allocating requirements, and selecting mechanisms. The systems engineer identifies components, or elements, allocates functions to those elements, and describes the relationships between the elements.

Develop detailed design

The systems engineer analyzes design constraints, analyzes trade-offs, does detailed system design, and considers life-cycle support. The systems engineer traces all of the system requirements to the elements until all are addressed. The final detailed design results in component and interface specifications that provide sufficient information for acquisition when the system is implemented.

Implement system

The systems engineer moves the system from specifications to the tangible. The main activities are acquisition, integration, configuration, testing, documentation, and training. Components are tested and evaluated to ensure that they meet the specifications. After successful testing, the individual components – hardware, software, and firmware – are integrated, properly configured, and tested as a system.

ISSE Activities**Design system security architecture**

The information systems security engineer works with the systems engineer in the areas of functional analysis and allocation by analyzing candidate architectures, allocating security services, and selecting security mechanisms. The information systems security engineer identifies components, or elements, allocates security functions to those elements, and describes the relationships between the elements.

Develop detailed security design

The information systems security engineer analyzes design constraints, analyzes trade-offs, does detailed system and security design, and considers life-cycle support. The information systems security engineer traces all of the system security requirements to the elements until all are addressed. The final detailed security design results in component and interface specifications that provide sufficient information for acquisition when the system is implemented.

Implement system security

The information systems security engineer participates in a multidisciplinary examination of all system issues and provides input to C&A process activities, such as verification that the system as implemented protects against the threats identified in the original threat assessment; tracking of information protection assurance mechanisms related to system implementation and testing practices; and providing input to system life-cycle support plans, operational procedures, and maintenance training materials.

SE Activities**Assess effectiveness**

The results of each activity are evaluated to ensure that the system will meet the users' needs by performing the required functions to the required quality standard in the intended environment. The systems engineer examines how well the system meets the needs of the mission.

ISSE Activities**Assess information protection effectiveness**

The information systems security engineer focuses on the effectiveness of the information protection – whether the system can provide the confidentiality, integrity, availability, authentication and nonrepudiation for the information it is processing that is required for mission success.

The Systems Development Life Cycle

National Institute of Standards and Technology (NIST) Special Publication 800-14, “Generally Accepted Principles and Practices for Securing Information Technology Systems,” defines the SDLC in terms of five phases:

1. Initiation
2. Development/acquisition
3. Implementation
4. Operation/maintenance
5. Disposal

Initiation

The need for the system and its purpose are documented. A sensitivity assessment is conducted as part of this phase. A sensitivity assessment evaluates the sensitivity of the IT system and the information to be processed.

Development/acquisition

In this phase, which includes the development and acquisition activities, the system is designed, developed, programmed, and acquired. Security requirements are developed simultaneously with the definition of the system requirements. The information security requirements include such items as access controls and security awareness training.

Implementation

Implementation involves installation, testing, security testing, and accreditation. During installation, security features should be enabled and configured. Also, system testing should be performed to ensure that the components function as planned. System security accreditation is performed in this phase. Accreditation is

the formal authorization for system operation by the accrediting official and an explicit acceptance of risk.

Operation/maintenance

The system performs its designed functions. This phase includes security operations, modification or addition of hardware or software, administration, operational assurance, monitoring, and audits. These activities include performing backups, conducting training classes, managing cryptographic keys, and updating security software.

Disposal

This last phase includes disposition of system components and products (such as hardware, software, and information), disk sanitization, archiving files, and moving equipment. Information may be moved to another system, archived, discarded, or destroyed. Keys for encrypted data should be stored in the event that the information is needed in the future. Data on magnetic media should be purged by overwriting, degaussing, or destruction.

Information systems security and the SDLC

A number of NIST documents describe methodologies and principles for incorporating information systems security into the SDLC. The primary documents are as follows:

- ♦ Generally Accepted Principles and Practices for Securing Information Technology Systems, SP 800-14, National Institute of Standards and Technology, September 1996. This publication defines 8 system security principles and 14 practices.
- ♦ Engineering Principles for Information Technology Security (EP-ITS), A Baseline for Achieving Security, SP 800-27, National Institute of Standards and Technology, June 2001. This document develops a set of 33 engineering principles for information technology security, which provide a system-level perspective of information system security. These 33 principles incorporate the concepts developed in the 8 principles and 14 practices detailed in SP 800-14.
- ♦ Security Considerations in the Information System Development Life Cycle, SP 800-64, National Institute of Standards and Technology, September–October 2003. NIST SP 800-64 details a framework for incorporating information systems security into all the phases of the SDLC activity, using cost-effective control measures.

Generally accepted principles for securing information technology

The Organization for Economic Cooperation and Development (OECD) guidelines (www.oecd.org) for the security of information systems were the foundation for the following eight information security principles of NIST Special Publication 800-14.

- ♦ Computer security supports the mission of the organization.
- ♦ Computer security is an integral element of sound management.
- ♦ Computer security should be cost-effective.

- ♦ Systems owners have security responsibilities outside their own organizations.
- ♦ Computer security responsibilities and accountability should be made explicit.
- ♦ Computer security requires a comprehensive and integrated approach.
- ♦ Computer security should be periodically reassessed.
- ♦ Computer security is constrained by societal factors.

Common practices for securing information technology

NIST SP 800-14 also lists the following common IT practices for incorporating information system security into the SDLC:

- ♦ **Policy**—Have in place the following three types of policies:
 - A *program policy* to create and define a computer security program
 - An *issue-specific policy* to address specific areas and issues
 - A *system-specific policy* to focus on decisions made by management

These policies are sometimes referred to as plans, procedures, or directives.

- ♦ **Program management**—Management of computer security at appropriate multiple levels with centralized enforcement and oversight.
- ♦ **Risk management**—The process of assessing risk, taking steps to reduce risk to an acceptable level, and maintaining that level of risk.
- ♦ **Life-cycle planning**—Managing security by planning throughout the system life cycle. A security plan should be developed prior to initiation of the life cycle activities so that it can be followed during the life-cycle process. Recall that the IT system life cycle as defined in SP 800-14 is composed of the following five phases:
 - Initiation
 - Development/Acquisition
 - Implementation
 - Operation/Maintenance
 - Disposal
- ♦ **Personnel/user issues**—These issues relate to managers, users, and implementers and their authorizations and access to IT computing resources.
- ♦ **Preparing for contingencies and disasters**—Planning to ensure that the organization can continue operations in the event of disasters and disruptions.
- ♦ **Computer security incident handling**—Reacting quickly and effectively in response to malicious code and internal or external unauthorized intrusions.
- ♦ **Awareness and training**—Providing computer security awareness training to all personnel interacting with the IT systems.

- ♦ **Security considerations in computer support and operations**—Applying information system security principles to the tasks performed by system administrators and to external system support activities.
- ♦ **Physical and environmental security**—Implementing environmental and physical security controls, such as maintaining proper temperature and humidity and securing laptops and magnetic media.
- ♦ **Identification and authentication**—Implementing the access control measures of identification and authentication to ensure that unauthorized personnel do not have privileges to access the resources of an IT system.
- ♦ **Logical access control**—Technical means of enforcing the information system security policy to limit access to IT resources to authorized personnel.
- ♦ **Audit trails**—Recording system activity and providing the capability to accomplish individual accountability, detection of intrusions, reconstruction of past events, and identification of problems.
- ♦ **Cryptography**—Providing security services, including protecting the confidentiality and integrity of information and implementing electronic signatures.

Engineering Principles for Information Technology Security (EP-ITS)

These 33 principles of NIST 800-27 are derived from concepts found in the 8 principles and 14 practices of SP 800-14 and provide a system-level approach to IT security.

1. Establish a sound security policy as the “foundation” for design.
2. Treat security as an integral part of the overall system design.
3. Clearly delineate the physical and logical security boundaries governed by associated security policies.
4. Reduce risk to an acceptable level.
5. Assume that external systems are insecure.
6. Identify potential trade-offs between reducing risk and increased costs and decrease in other aspects of operational effectiveness.
7. Implement layered security (ensure no single point of vulnerability).
8. Implement tailored system security measures to meet organizational security goals.
9. Strive for simplicity.
10. Design and operate an IT system to limit vulnerability and to be resilient in response.
11. Minimize the system elements to be trusted.
12. Implement security through a combination of measures distributed physically and logically.

13. Provide assurance that the system is, and continues to be, resilient in the face of unexpected threats.
14. Limit or contain vulnerabilities.
15. Formulate security measures to address multiple overlapping information domains.
16. Isolate public access systems from mission-critical resources (for example, data processes).
17. Use boundary mechanisms to separate computing systems and network infrastructures.
18. Where possible, base security on open standards for portability and interoperability.
19. Use common language in developing security requirements.
20. Design and implement audit mechanisms to detect unauthorized use and to support incident investigations.
21. Design security to allow for regular adoption of new technology, including a secure and logical technology upgrade process.
22. Authenticate users and processes to ensure appropriate access control decisions both within and across domains.
23. Use unique identities to ensure accountability.
24. Implement least privilege.
25. Do not implement unnecessary security mechanisms.
26. Protect information while it is being processed, in transit, and in storage.
27. Strive for operational ease of use.
28. Develop and exercise contingency or disaster recovery procedures to ensure appropriate availability.
29. Consider custom products to achieve adequate security.
30. Ensure proper security in the shutdown or disposal of a system.
31. Protect against all likely classes of attacks.
32. Identify and prevent common errors and vulnerabilities.
33. Ensure that developers are trained to develop secure software.

Information system development cycle

Publication 800-64, “Security Considerations in the Information System Development Life Cycle,” complements NIST Special Publications 800-14 and 800-27 and expands on the SDLC concepts presented in these two publications. Table 1-5, taken from SP 800-64, illustrates information systems security as applied in the SDLC.

Table 1-5
Information Systems Security in the SDLC

	<i>Initiation</i>	<i>Acquisition/ Development</i>	<i>Implementation</i>	<i>Operations/ Maintenance</i>	<i>Disposition</i>
SDLC	<p>Needs determination:</p> <ul style="list-style-type: none"> • Perception of a need • Linkage of need to mission and performance objectives • Assessment of alternatives to capital assets • Preparing for investment review and budgeting 	<p>Functional statement of need:</p> <p>Market research</p> <p>Feasibility study</p> <p>Requirements analysis</p> <p>Alternatives analysis</p> <p>Cost-benefit analysis</p> <p>Software conversion study</p> <p>Cost analysis</p> <p>Risk management plan</p> <p>Acquisition planning</p>	<p>Installation inspection</p> <p>Acceptance testing</p> <p>Initial user training</p> <p>Documentation</p>	<p>Performance measurement</p> <p>Contract modifications</p> <p>Operations</p> <p>Maintenance</p>	<p>Appropriateness of disposal</p> <p>Exchange and sale</p> <p>Internal organization screening</p> <p>Transfer and donation</p> <p>Contract closeout</p>

Security Considerations	Security categorization: Preliminary risk assessment	Risk assessment Security functional requirements analysis Security assurance requirements analysis Cost considerations and reporting Security planning	Inspection and acceptance Security control integration Security certification Security accreditation	Configuration management and control Continuous monitoring	Information preservation Media sanitization Hardware and software disposal
		Security control development Developmental security test and evaluation Other planning components			

Continued

Table 1-5 (continued)

	Initiation	Acquisition/ Development	Implementation	Operations/ Maintenance	Disposition
Security Considerations	Security categorization	Risk assessment	Inspection and acceptance	Configuration management and control	Information preservation
	Preliminary risk assessment	Security functional requirements analysis	Security control integration	Continuous monitoring	Media sanitization
		Security assurance requirements analysis	Security certification		Hardware and software disposal
		Cost considerations and reporting	Security accreditation		
		Security planning			
		Security control development			
		Developmental security test and evaluation			
		Other planning components			

The activities of each step in Table 1-5, as described in NIST SP 800-64, are expanded in the following list:

♦ **Initiation phase:**

- **Security categorization** — Defines three levels (low, moderate, or high) of potential impact on organizations or individuals should there be a breach of security (a loss of confidentiality, integrity, or availability). Security categorization standards assist organizations in making the appropriate selection of security controls for their information systems.
- **Preliminary risk assessment** — Results in an initial description of the basic security needs of the system. A preliminary risk assessment should define the threat environment in which the system will operate.

♦ **Acquisition and development phase:**

- **Risk assessment** — An analysis that identifies the protection requirements for the system through a formal risk assessment process. This analysis builds on the initial risk assessment performed during the Initiation phase, but will be more in-depth and specific.
- **Security functional requirements analysis** — An analysis of requirements that may include the following components: a system security environment (that is, enterprise information security policy and enterprise security architecture) and security functional requirements.
- **Assurance requirements analysis security** — An analysis of requirements that address the developmental activities required and assurance evidence needed to produce the desired level of confidence that the information security will work correctly and effectively. The analysis, based on legal and functional security requirements, will be used as the basis for determining how much and what kinds of assurance are required.
- **Cost considerations and reporting** — Determines how much of the development cost can be attributed to information security over the life cycle of the system. These costs include hardware, software, personnel, and training.
- **Security planning** — Ensures that agreed-upon security controls, planned or in place, are fully documented. The security plan also provides a complete characterization or description of the information system as well as attachments or references to key documents supporting the agency's information security program (for example, configuration management plan, contingency plan, incident response plan, security awareness and training plan, rules of behavior, risk assessment, security test and evaluation results, system interconnection agreements, security authorizations and accreditations, and plan of action and milestones).

- **Security control development**—Ensures that security controls described in the respective security plans are designed, developed, and implemented. For information systems currently in operation, the security plans for those systems may call for the development of additional security controls to supplement the controls already in place or the modification of selected controls that are deemed to be less than effective.
- **Developmental security test and evaluation**—Ensures that security controls developed for a new information system are working properly and are effective. Some types of security controls (primarily those controls of a nontechnical nature) cannot be tested and evaluated until the information system is deployed—these controls are typically management and operational controls.
- **Other planning components**—Ensures that all necessary components of the development process are considered when incorporating security into the life cycle. These components include selection of the appropriate contract type, participation by all necessary functional groups within an organization, participation by the certifier and accreditor, and development and execution of necessary contracting plans and processes.

♦ **Implementation phase:**

- **Inspection and Acceptance**—Ensures that the organization validates and verifies that the functionality described in the specification is included in the deliverables.
- **Security Control Integration**—Ensures that security controls are integrated at the operational site where the information system is to be deployed for operation. Security control settings and switches are enabled in accordance with vendor instructions and available security implementation guidance.
- **Security certification**—Ensures that the controls are effectively implemented through established verification techniques and procedures and gives organization officials confidence that the appropriate safeguards and countermeasures are in place to protect the organization's information system. Security certification also uncovers and describes the known vulnerabilities in the information system.
- **Security accreditation**—Provides the necessary security authorization of an information system to process, store, or transmit information that is required. This authorization is granted by a senior organization official and is based on the verified effectiveness of security controls to some agreed-upon level of assurance and an identified residual risk to agency assets or operations.

♦ **Operations and maintenance phase:**

- **Configuration management and control**—Ensures adequate consideration of the potential security impacts due to specific changes to an

information system or its surrounding environment. Configuration management and configuration control procedures are critical to establishing an initial baseline of hardware, software, and firmware components for the information system and subsequently controlling and maintaining an accurate inventory of any changes to the system.

- **Continuous monitoring**—Ensures that controls continue to be effective in their application through periodic testing and evaluation. Security control monitoring (that is, verifying the continued effectiveness of those controls over time) and reporting the security status of the information system to appropriate agency officials is an essential activity of a comprehensive information security program.

♦ **Disposition phase:**

- **Information preservation**—Ensures that information is retained, as necessary, to conform to current legal requirements and to accommodate future technology changes that may render the retrieval method obsolete.
- **Media sanitization**—Ensures that data is deleted, erased, and written over, as necessary.
- **Hardware and software disposal**—Ensures that hardware and software is disposed of as directed by the information system security officer. After discussing these phases and the information security steps in detail, the guide provides specifications, tasks, and clauses that can be used in a request for proposal (RFP) to acquire information security features, procedures, and assurances.

Risk Management

NIST Special Publication 800-30, “Risk Management Guide for Information Technology Systems,” defines *risk management* as comprising three processes: *risk assessment*, *risk mitigation*, and *evaluation and assessment*.

Risk assessment consists of the following:

- ♦ Identification and evaluation of risks
- ♦ Identification and evaluation of risk impacts
- ♦ Recommendation of risk-reducing measures

Risk mitigation involves the following:

- ♦ Prioritizing appropriate risk-reducing measures recommended from the risk assessment process

- ♦ Implementing appropriate risk-reducing measures recommended from the risk assessment process
- ♦ Maintaining the appropriate risk-reducing measures recommended from the risk assessment process

Evaluation and assessment includes a continuous evaluation process. For example, the designated approving authority, (DAA) has the responsibility for determining if the residual risk in the system is acceptable or if additional security controls should be implemented to achieve accreditation of the IT system.

The DAA is the primary government official responsible for implementing system security. The DAA is an executive with the authority and ability to balance the needs of the system with the security risks. This person determines the acceptable level of residual risk for a system and must have the authority to oversee the budget and IS business operations of systems under his/her purview.

Definitions

It is important to understand key definitions associated with risk management. These terms are taken from SP 800-30 and are useful in the discussion of applying risk management to the SDLC process.

Risk

Risk is “a function of the likelihood of a given threat-source’s exercising a particular potential vulnerability, and the resulting impact of that adverse event on the organization.”

Threat

A *threat* is defined as “the potential for a threat-source to exercise (accidentally trigger or intentionally exploit) a specific vulnerability.”

Threat-source

A *threat-source* is defined as “either (1) intent and method targeted at the intentional exploitation of a vulnerability or (2) a situation and method that may accidentally trigger a vulnerability.” Common threat-sources include *natural threats*, such as storms and floods, *human threats*, such as malicious attacks and unintentional acts, and *environmental threats*, such as power failure and liquid leakage.

Vulnerability

A *vulnerability* is defined as “a flaw or weakness in system security procedures, design, implementation, or internal controls that could be exercised (accidentally triggered or intentionally exploited) and result in a security breach or a violation of the system’s security policy.”

Impact

Impact refers to the “magnitude of harm that could be caused by a threat exploiting a vulnerability. The level of impact is governed by the potential mission impacts and in turn produces a relative value for the IT assets and resources affected (the criticality and sensitivity of the IT system components and data).”

Risk management and the SDLC

The risk management process minimizes the impact of threats realized and provides a foundation for effective management decision-making. Thus, it is very important that risk management be a part of the system development life cycle. The three risk management processes, risk assessment, risk mitigation, and evaluation and assessment, are to be performed during each of the five phases of the SDLC. Table 1-6, taken from NIST SP 800-30, details the risk management activities that should be performed for each SDLC phase.

**Table 1-6
Risk Management in the SDLC Cycle**

<i>SDLC</i>	<i>Phase</i>	<i>Risk Management Activities</i>
Phase 1 – Initiation	The need for an IT system is expressed and the purpose and scope of the IT system is documented.	Identified risks are used to support the development of the system requirements, including security requirements, and a security concept of operations (strategy).
Phase 2 – Development or Acquisition	The IT system is designed, purchased, programmed, developed, or otherwise constructed.	The risks identified during this phase can be used to support the security analyses of the IT system that may lead to architecture and design tradeoffs during system development.
Phase 3 – Implementation	The system security features should be configured, enabled, tested, and verified.	The risk management process supports the assessment of the system implementation against its requirements and within its modeled operational environment. Decisions regarding risks identified must be made prior to system operation.

Continued

Table 1-6 (continued)

<i>SDLC</i>	<i>Phase</i>	<i>Risk Management Activities</i>
Phase 4 – Operation or Maintenance	The system performs its functions. Typically, the system is being modified on an ongoing basis through the addition of hardware and software and by changes to organizational processes, policies, and procedures.	Risk management activities are performed for periodic system reauthorization (or reaccreditation) or whenever major changes are made to an IT system in its operational, production environment (for example, new system interfaces).
Phase 5 – Disposal	This phase may involve the disposition of information, hardware, and software. Activities may include moving, archiving, discarding, or destroying information and sanitizing the hardware and software.	Risk management activities are performed for system components that will be disposed of or replaced to ensure that the hardware and software are properly disposed of, that residual data is appropriately handled, and that system migration is conducted in a secure and systematic manner.

To be effective, risk management must be supported by management and information system security practitioners. Some of the key personnel that should actively participate in the risk management activities follow:

- ♦ **Senior management**—Provides the required resources and meets responsibilities under the principle of due care
- ♦ **Chief information officer (CIO)**—Considers risk management in IT planning, budgeting, and meeting system performance requirements
- ♦ **System and information owners**—Ensures that controls and services are implemented to address information system confidentiality, integrity, and availability
- ♦ **Business and functional managers**—Makes trade-off decisions regarding business operations and IT procurement that affect information security
- ♦ **Information system security officer (ISSO)**—Participates in applying methodologies to identify, evaluate, and reduce risks to the mission-critical IT systems
- ♦ **IT security practitioners**—Ensures the correct implementation of IT system information system security requirements
- ♦ **Security awareness trainers**—Incorporates risk assessment in training programs for the organization's personnel

Risk assessment

Risk assessment comprises the following steps:

1. System characterization
2. Threat identification
3. Vulnerability identification
4. Control analysis
5. Likelihood determination
6. Impact analysis
7. Risk determination
8. Control recommendations
9. Results documentation

Each of these steps is summarized in the following sections.

System characterization

This step characterizes and defines the scope of the risk assessment process. During this step, the following information about the system must be gathered:

- ♦ Software
- ♦ Hardware
- ♦ Data
- ♦ System interfaces
- ♦ IT system users
- ♦ IT system support personnel
- ♦ System mission
- ♦ Criticality of the system and data
- ♦ System and data sensitivity
- ♦ Functional system requirements
- ♦ System security policies
- ♦ System security architecture
- ♦ Network topology
- ♦ Information storage protection
- ♦ System information flow
- ♦ Technical security controls

- ♦ Physical security environment
- ♦ Environmental security

Questionnaires, on-site interviews, review of documents, and automated scanning tools are used to obtain the required information. The output from this step is as follows:

- ♦ Characterization of the assessed IT system
- ♦ Comprehension of the IT system environment
- ♦ Delineation of the system boundary

Threat identification

This step identifies potential threat-sources and compiles a statement of the threat-sources that relate to the IT system under evaluation. Sources of threat information include the Federal Computer Incident Response Center (FedCIRC), intelligence agencies, mass media, and Web-based resources.

The output from this step is a statement that provides a list of threat-sources that could exploit the system's vulnerabilities.

Vulnerability identification

This step results in a list of system vulnerabilities that might be exploited by potential threat-sources. Vulnerabilities can be identified through vulnerability analyses, including information from previous information assessments; audit reports; the NIST vulnerability database (<http://icat.nist.gov/icat.cfm>); FedCIRC and DOE security bulletins; vendor data; commercial computer incident response teams; and system software security analyses.

Testing of the IT system is also an important tool in identifying vulnerabilities. Testing can include the following:

- ♦ Security test and evaluation (ST&E) procedures
- ♦ Penetration-testing techniques
- ♦ Automated vulnerability scanning tools

This phase also involves determining whether the security requirements identified during system characterization are being met. Usually, the security requirements are listed in a table with a corresponding statement about how the requirement is or is not being met. The checklist addresses management, operational, and technical information system security areas. The result of this effort is a *security requirements checklist*. Some useful references for this activity are the Computer Security Act of 1987, the Privacy Act of 1974, the organization's security policies, industry best practices, and NIST SP 800-26, *Security Self-Assessment Guide for Information Technology Systems*.

The output from this step is a list of system vulnerabilities or observations that could be exploited by the potential threat-sources.

Control analysis

This step analyzes the controls that are in place or in the planning stage to minimize or eliminate the probability that a threat will exploit vulnerability in the system.

Controls can be implemented through technical means such as computer hardware or software, encryption, intrusion detection mechanisms, and identification and authentication subsystems. Other controls, such as security policies, administrative actions, and physical and environmental mechanisms, are considered nontechnical controls. Both technical and nontechnical controls can further be classified as preventive or detective controls. As the names imply, preventive controls attempt to anticipate and stop attacks. Examples of preventive, technical controls are encryption and authentication devices. Detective controls are used to discover attacks or events through such means as audit trails and intrusion detection systems.

Changes in the control mechanisms should be reflected in the security requirement checklist.

The output of this step is a list of current and planned control mechanisms for the IT system to reduce the likelihood that a vulnerability will be exercised and to reduce the impact of an attack or event.

Likelihood determination

This activity develops a rating that provides an indication of the probability that a potential vulnerability might be exploited based on the defined threat environment. This rating takes into account the type of vulnerability, the capability and motivation of the threat-source, and the existence and effectiveness of information system security controls. The likelihood levels are given as high, medium, and low, as illustrated in Table 1-7.

Table 1-7
Definitions of Likelihood

Level of Likelihood	Definition of Likelihood
High	A highly motivated and capable threat-source and ineffective controls to prevent exploitation of the associated vulnerability
Medium	A highly motivated and capable threat-source and controls that might impede exploitation of the associated vulnerability
Low	Lack of motivation or capability in the threat-source or controls in place to prevent or significantly impede the exploitation of the associated vulnerability

The output of this step is a likelihood rating of high, medium, or low.

Impact analysis

Three important factors should be considered in calculating the negative impact of a threat realized:

- ♦ The mission of the system, including the processes implemented by the system
- ♦ The criticality of the system, determined by its value and the value of the data to the organization
- ♦ The sensitivity of the system and its data

The information necessary to conduct an impact analysis can be obtained from existing organizational documentation, including a business impact analysis (BIA), or mission impact analysis report, as it is sometimes called. This document uses either quantitative or qualitative means to determine the impacts caused by compromise or harm to the organization's information assets. An attack or adverse event can result in compromise or loss of information system confidentiality, integrity, and availability. As with the likelihood determination, the impact on the system can be qualitatively assessed as high, medium, or low, as shown in Table 1-8.

Table 1-8 Definitions of Likelihood	
<i>Impact Magnitude</i>	<i>Definition of Impact</i>
High	Possibility of costly loss of major tangible assets or resources; might cause significant harm or impedance to the mission of an organization; might cause significant harm to an organization's reputation or interest; might result in human death or injury
Medium	Possibility of costly loss of tangible assets or resources; might cause harm or impedance to the mission of an organization; might cause harm to an organization's reputation or interest; might result in human injury
Low	Possibility of loss of some tangible assets or resources; might noticeably affect an organization's mission; might noticeably affect an organization's reputation or interest

The following additional items should be included in the impact analysis:

- ♦ The estimated frequency of the threat-source's exploitation of a vulnerability on an annual basis
- ♦ The approximate cost of each of these occurrences

- ♦ A weight factor based on the relative impact of a specific threat exploiting a specific vulnerability

The output of this step is the magnitude of impact: high, medium, or low.

Risk determination

This step determines the level of risk to the IT system. The risk is assigned for a threat/vulnerability pair and is a function of the following characteristics:

- ♦ The likelihood that a particular threat-source will exploit an existing IT system vulnerability
- ♦ The magnitude of the resulting impact of a threat-source successfully exploiting the IT system vulnerability
- ♦ The adequacy of the existing or planned information system security controls for eliminating or reducing the risk

Mission risk is calculated by multiplying the threat likelihood ratings (the probability that a threat will occur) by the impact of the threat realized. A useful tool for estimating risk in this manner is the risk-level matrix. An example risk-level matrix is shown in Table 1-9. In the table, a high likelihood that the threat will occur is given a value of 1.0; a medium likelihood is assigned a value of 0.5; and a low likelihood of occurrence is given a rating of 0.1. Similarly, a high impact level is assigned a value of 100, a medium impact level 50, and a low impact level 10.

**Table 1-9
A Risk-Level Matrix Example**

<i>Likelihood of Threat</i>	<i>Low Impact (10)</i>	<i>Medium Impact (50)</i>	<i>High Impact (100)</i>
High (1.0)	Low $10 \times 1.0 = 10$	Medium $50 \times 1.0 = 50$	High $100 \times 1.0 = 100$
Medium (0.5)	Low $10 \times 0.5 = 5$	Medium $50 \times 0.5 = 25$	High $100 \times 0.5 = 50$
Low (0.1)	Low $10 \times 0.1 = 1$	Medium $50 \times 0.1 = 5$	High $100 \times 0.1 = 10$

Using the risk level as a basis, the next step is to determine the actions that senior management and other responsible individuals must take to mitigate estimated risk. General guidelines for each level of risk follow:

- ♦ **High-risk level**—At this level, there is a high level of concern—and a strong need for a plan for corrective measures to be developed as soon as possible.
- ♦ **Medium-risk level**—For medium risk, there is concern and a need for a plan for corrective measures to be developed within a reasonable period of time.
- ♦ **Low-risk level**—For low risk, the system's DAA must decide whether to accept the risk or implement corrective actions.

The output of the risk determination step is risk level of high, medium, or low.

Control recommendations

This step specifies the controls to be applied for risk mitigation. To specify appropriate controls, the following issues must be considered:

- ♦ Organizational policy
- ♦ Cost-benefit
- ♦ Operational impact
- ♦ Feasibility
- ♦ Applicable legislative regulations
- ♦ The overall effectiveness of the recommended controls
- ♦ Safety, reliability

The output of this step is a recommendation of controls and any alternative solutions to mitigate risk.

Results documentation

The final step in the risk assessment process is the development of a risk assessment report. This report is directed at management and should contain information to support appropriate decisions on budget, policies, procedures, management, and operational issues.

The output of this step is a risk assessment report that describes threats and vulnerabilities, risk measurements, and recommendations for implementation of controls.

Risk mitigation

Risk mitigation prioritizes, evaluates, and implements the controls that are an output of the risk assessment process. Because risk can never be completely eliminated and control implementation must make sense under a cost-benefit analysis, a least-cost approach with minimal adverse impact on the IT system is usually taken.

Risk mitigation options

Risk mitigation can be classified into the following options:

- ♦ **Risk assumption** — Accept the risk and keep operating.
- ♦ **Risk avoidance** — Forgo some functions.
- ♦ **Risk limitation** — Implement controls to minimize the adverse impact of threats realized.

- ♦ **Risk planning**—Develop a risk mitigation plan to prioritize, implement, and maintain controls.
- ♦ **Research and development**—Research control types and options.
- ♦ **Risk transference**—Transfer risk to other sources, such as purchasing insurance.

Categories of controls

Controls to mitigate risks can be broken into the following categories:

- ♦ Technical
- ♦ Management
- ♦ Operational
- ♦ A combination of the above

Technical controls comprise the following:

- ♦ **Supporting controls**—These controls implement identification, cryptographic key management, security administration, and system protections.
- ♦ **Preventive controls**—Preventive technical controls include authentication, authorization, access control enforcement, nonrepudiation, protected communications, and transaction privacy.
- ♦ **Detection and recovering controls**—These technical controls include audit, intrusion detection and containment, proof of wholeness (system integrity), restoration to a secure state, and virus detection and eradication.

Management controls comprise the following:

- ♦ **Preventive controls**—Preventive management controls include assigning responsibility for security, and developing and maintaining security plans, personnel security controls, and security awareness and technical training.
- ♦ **Detection controls**—Detection controls involve background checks, personnel clearance, periodic review of security controls, periodic system audits, risk management, and authorization of IT systems to address and accept residual risk.
- ♦ **Recovery controls**—These controls provide continuity of support to develop, test, and maintain the continuity of the operations plan and establish an incident response capability.

Operational security controls are divided into preventive and detection types. Their functions are listed as follows:

- ♦ **Preventive controls**— These operational controls comprise control of media access and disposal, limiting external data distribution, control of software viruses, securing wiring closets, providing backup capability, protecting laptops and personal computers, protecting IT assets from fire damage, providing an emergency power source, and control of humidity and temperature.
- ♦ **Detection controls**— Detection operation controls include providing physical security through the use of items such as cameras and motion detectors and ensuring environmental security by using smoke detectors, sensors, and alarms.

Evaluation and assessment

The risk that remains after the implementation of controls is called the *residual risk*. All systems will have residual risk because it is virtually impossible to completely eliminate risk to an IT system. An organization's senior management or the DAA is responsible for authorizing or accrediting the IT system to begin or continue to operate. The authorization or accreditation must take place every three years in federal agencies or whenever major changes are made to the system. The DAA signs a statement accepting the residual risk when accrediting the IT system for operation. If the DAA determines that the residual risk is at an unacceptable level, the risk management cycle must be redone with the objective of lowering the residual risk to an acceptable level.

Summary

The formal SE process and the corresponding ISSE process provide a solid framework for specifying, designing, implementing, and assessing high-quality and secure information systems. Similarly, risk management and information system security principles applied throughout the SDLC ensure that the target system maintains an acceptable level of risk from its development phase through to its disposal phase. The layered Defense-in-Depth strategy supports the SE, ISSE, SDLC, and risk management processes in providing an effective implementation strategy for securing the enclave boundary.



Information System Security Management

Information system security management comprises a variety of techniques that can significantly reduce the risk of compromise to confidentiality, integrity, and availability information systems. Management tools and techniques, although not as glamorous as high-tech approaches, can be highly effective in implementing and maintaining information system security at reasonable cost. Such tools include security policies, vacation scheduling, employee background checks, awareness training, and contingency planning. Just as social engineering can easily help you acquire information that would require large expenditures of time and resources to obtain by technical means, information security management practices can produce significant reductions in risk at reasonable cost.

This chapter describes the tools and techniques of information system security management, including administrative procedures, recovery methods, back up of critical data, physical security, and legal or liability issues.

Security Policies

High-level policies are general statements of management's intent. Policies are usually mandatory; however, some policies are either strong recommendations or informative resources.

A policy should be applied throughout the organization in a consistent manner and provide a reference for employees in the conduct of their everyday activities. A well-thought-out and well-written policy also provides liability protection for an organization and its senior management.



In This Chapter

Understanding security policies, standards, guidelines, and procedures

Conducting security awareness training

Managing the technical effort

Developing business continuity and disaster recovery plans

Implementing physical security

Understanding legal and liability issues



Policies are at the top of the hierarchy of policies, standards, guidelines, baselines, and procedures, as shown in Figure 2-1.

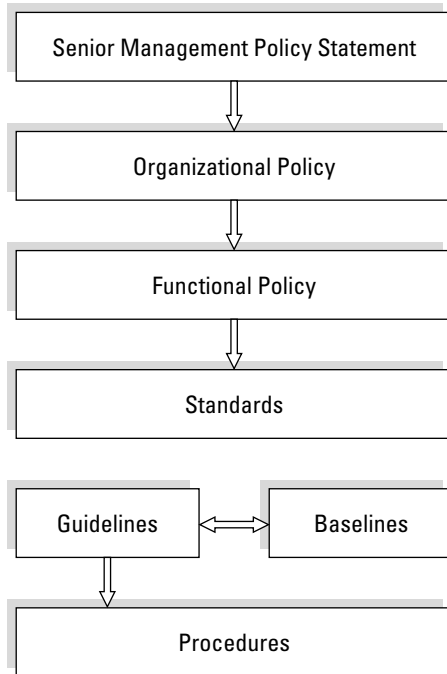

Figure 2-1: Hierarchy of policies, standards, baselines, guidelines, and procedures

Senior management policy statement

The senior management policy statement sets the tone and guidance for the standards, guidelines, baselines, and procedures to be followed by the organization. For a security policy, this statement declares the importance of securing the networks and computing resources of the organization, management's commitment to information system security, and authorization for the development of standards, procedures, and guidelines. This senior management policy statement might also indicate individuals or roles in the organization that have responsibilities for policy tasks.

Specific instantiations of senior management policy statements are *advisory*, *regulatory*, and *informative* policies. The National Institute of Standards and Technology (NIST) defines additional policies for use by U.S. government agencies. These policies are program specific, system specific, and issue specific.

Advisory policies

Even though policies are usually considered mandatory, *advisory* security policies are strong recommendations. These policies recommend courses of action or approaches but allow for independent judgment in the event of special cases. The advisory policy can provide guidance as to its application and indicate circumstances where it might not be applicable, such as during an emergency.

Regulatory policies

Regulatory policies are intended to ensure that an organization implements the standard procedures and best practices of its industry. These policies apply to institutions such as banks, insurance companies, investment companies, public utilities, and so on.

Informative policies

Informative policies provide information and, generally, require no action by the affected individuals. An informative policy, however, might prohibit and specify penalties for certain activities, such as downloading objectionable material on an organization's computer. The policy would, therefore, inform the user of the prohibited activities and resultant consequences of practicing those activities.

U.S. Government policy types

The NIST provides guidance in the area of information system and network security policies for government agencies. NIST Special Publication 800-12, "An Introduction to Computer Security," divides computer system security policies into three categories:

- ♦ **Program policies** are strategic statements addressing an organization's computer and network security program.
- ♦ **System-specific policies** are concerned with the technical aspects of a particular computer, network, or device type.
- ♦ **Issue-specific policies** focus on specific situations on a non-technical, strategic basis. An example of an issue-specific policy would be directives concerning unlicensed use of software packages.

Standards, guidelines, procedures, and baselines

Standards, guidelines, procedures, and baselines flow from the high-level policy statements and serve to realize the high level policy.

- ♦ **Standards** are compulsory and usually refer to specific hardware and/or software. For example, an organization might specify a standard operating system or standard platform that must be used by all of its employees. By employing standards, an organization can implement security controls effectively for the enterprise.

- ♦ **Guidelines** are suggestions to the personnel of an organization on how to effectively secure their networks and computers. Guidelines provide flexibility and allow users to implement security controls in more than one way. They also can be used to ensure that important security measures are not overlooked.
- ♦ **Procedures** are compulsory, detailed steps to be followed in order to accomplish specific tasks. The step-by-step activities described in a procedure serve to implement the higher-level policy statement, standards, and guidelines. Examples of procedures are those used in preparing new user accounts or assigning privileges.
- ♦ **Baselines** are similar to standards and represent a level of implementation of security controls that provides protection that is equivalent to the protection available to other similar reference entities. The baseline of controls should be applied consistently across an organization, and provides the basis for development of the computer and network security architectures. The baseline level of protection is compulsory and can be used to develop the required organizational information system security standards.

Security Awareness

Senior management has the obligation to ensure that the employees of an organization are aware of their responsibilities in protecting that organization's computers and networks from compromise. Similarly, employees should be diligent in their everyday work habits and embrace good information system security practices. *Security awareness* refers to the collective consciousness of an organization's employees relative to security controls and their application to the protection of the organization's critical and sensitive information.

Employee's security awareness can have a significant impact on detecting fraud, reducing unauthorized computer- and network-related activities, and preventing security compromises in general.

Demonstrating that there are consequences for violating an organization's security policy can emphasize the importance of security awareness and good information system security practices. Employees found in violation of the security policy should be issued a warning, be reprimanded, or, in extreme cases, fired for compromising the organization's computer and network security. Security awareness can also be reinforced through bulletins, newsletters, incentives, recognition, and reminders in the form of log-on banners, lectures, and videos.

Training

Training is a tool that can increase employees' security awareness and capabilities in identifying, reporting, and handling compromises of confidentiality, integrity, and availability of information systems. Some typical types of security training and target audiences are given in Table 2-1.

Table 2-1
Types of Information Security Training

<i>Training Type</i>	<i>Target Audience</i>
Awareness	Personnel with security-sensitive positions
Security-related job training	Operators and other designated users
High-level security training	Senior managers, functional managers, and business unit managers
Technical security training	IT support personnel and system administrators
Advanced information security training	Security practitioners and information systems auditors
Specific security software and hardware product training	Operators, IT support personnel, system administrators, security practitioners, and selected users

Measuring awareness

Information security awareness should be an institutionalized characteristic of an organization and practiced as part of employees' everyday activities. The level of practiced security awareness should be sampled at reasonable intervals to obtain assurance that related training and reminders are effective. Questionnaires, interactive meetings, and hypothetical problem exercises can be used to measure employees' security awareness. For example, one can obtain a fairly accurate picture of the level of security awareness in an organization by asking the following questions to a sampling of its personnel:

- ♦ Does your organization have an information security policy?
- ♦ Do you have a copy of that policy?
- ♦ Do you refer to that policy frequently?
- ♦ Do you know what security awareness means?
- ♦ How often does your organization conduct security awareness training and refresher sessions?
- ♦ Do you feel your security awareness training provides with the necessary knowledge and skills to handle information security incidents?
- ♦ Are you aware of what would be considered an information security incident?
- ♦ If you think an incident has occurred, what actions would you take?
- ♦ To whom would you report an incident?
- ♦ Do you feel comfortable in handling an information security incident?

Managing the Technical Effort

Security engineering should be an integrated component of the overall development effort of a product or service. A successful security system engineering activity is the result of early and competent planning as well as effective management. A program management plan supports proper planning and also serves in the development of a systems engineering management plan that incorporates the system security engineering requirements. A key individual in carrying out these plans is the program manager. These elements are addressed in the following sections.

Program manager

A *program* is defined as a number of related projects that are managed as a whole by a program manager. A *program manager* must administer processes that are used to develop complex systems and is responsible for the system budget, schedule, and performance objectives. These systems are the result of the integration of systems engineering, systems security engineering, risk management, advanced planning, and effective management techniques.

The program management plan and the systems engineering management plan are tools used by the program manager to control the variables associated with a program and ensure delivery of a quality product.

One of the organizations that has developed and refined program management techniques is the U.S. Department of Defense (DoD). By its very nature, the DoD has to acquire, manage, and maintain complex systems ranging from healthcare records to missile systems. Thus, the DoD approach provides a good example of effective program management principles and practices.

Program management plan

The *program management plan* is a high-level planning document for the program and is the basis for other subordinate-level documents. The PMP also includes the high-level system requirements. The systems engineering management plan and a test and evaluation master plan evolve from the program management plan.

Systems engineering management plan

The *systems engineering management plan* integrates all the lower-level planning documents and supports the requirements in the high-level system specifications. It is the highest-level technical plan that supports the integration of subordinate technical plans of various disciplines. It contains the following:

- ♦ Directions for development of an organizational team
- ♦ Design tasks for the system development effort

Department of Defense (DoD) Regulation 5000.2-R Change 3, Mandatory Procedures for Major Defense Acquisition Programs (MDAPs) and Major Automated Information System (MAIS) Acquisition Programs

In the U.S. Department of Defense, a program manager is responsible for controlling many critical factors, including performance, costs, schedules, personnel issues, and applicable regulations. For network security, the program manager is responsible for ensuring that the security requirements are integrated into the system architecture and the resulting risk is acceptable. According to DoD Regulation 5000.2-R, Change 3, March 15, 1996:

... every acquisition program shall establish an Acquisition Program Baseline (APB) to document the cost, schedule, and performance objectives and thresholds of that program beginning at program initiation. ...The program manager, in coordination with the user, shall prepare the APB at program initiation ... at each subsequent major milestone decision, and following a program restructure or an unrecoverable program deviation. ... The APB shall contain only the most important cost, schedule, and performance parameters. The most important parameters are those that, if the thresholds were not met, the Milestone Decision Authority (MDA) would require a reevaluation of alternative concepts or design approaches. ... At each milestone review, the PM shall propose exit criteria appropriate to the next phase of the program. Exit criteria are normally selected to track progress in important technical, schedule, or management risk areas. The exit criteria shall serve as gates that, when successfully passed or exited, demonstrate that the program is on track to achieve its final program goals and should be allowed to continue with additional activities within an acquisition phase or be considered for continuation into the next acquisition phase.

- ♦ Concurrent engineering methods
- ♦ References for conducting systems security engineering tasks
- ♦ Delineation of responsibilities

Some of the principal headings in a typical systems engineering management plan include the following:

- ♦ System Engineering Process
 - Operational Requirements
 - Technical Performance Measures
 - System Level Functional Analysis
 - System Test and Evaluation

- ♦ Technical Program Planning and Control
 - Statement of Work
 - Organizational Interfaces
 - Work Breakdown Structure
 - Scheduling and Cost Estimation
 - Technical Performance Measurement
- ♦ Engineering Integration
 - Electrical Engineering
 - Mechanical Engineering
 - Other Engineering Disciplines
 - Security Engineering
- ♦ Configuration Management
- ♦ Data Management
- ♦ Risk Management
- ♦ Reference Documents

Key components of the systems engineering management plan (the statement of work, work breakdown structure, technical performance measurement, and the test and evaluation master plan) are discussed in detail in the following sections.

Statement of work

A *statement of work* is a detailed description of the tasks and deliverables required for a given project. It is derived from the general statement of work given in the program management plan. The statement of work includes the following:

- ♦ A listing and description of the tasks to be accomplished.
- ♦ Items to be delivered and a proposed schedule of delivery
- ♦ Input requirements from other tasks
- ♦ Special requirements and conditions
- ♦ References to applicable specifications, standards, and procedures

Work breakdown structure

The *work breakdown structure* (WBS) is a systematic organization of activities, tasks, and subtasks that must be performed to complete a project. It is a deliverable-oriented grouping of project components that organizes and defines the total scope of the project; work not in the WBS is outside the scope of the project.

The WBS is applicable across a variety of applications and disciplines. A good overview of the WBS is provided in the U.S. *Department of Defense Handbook*, “Work Breakdown Structure”, MIL-HDBK-881, dated January 2, 1998. It formally defines the WBS as having the following characteristics:

- ♦ “A product-oriented family tree composed of hardware, software, services, data, and facilities. The family tree results from systems engineering efforts during the acquisition of a defense materiel item.”
- ♦ “A WBS displays and defines the product, or products, to be developed and/or produced. It relates the elements of work to be accomplished to each other and to the end product.”
- ♦ “A WBS can be expressed down to any level of interest. However the top three levels are as far as any program or contract need go unless the items identified are high cost or high risk. Then, and only then, is it important to take the work breakdown structure to a lower level of definition.”

The WBS generally includes three levels of activity:

- ♦ Level 1 — Identifies the entire program scope of work to be produced and delivered. Level 1 may be used as the basis for the authorization for of the program work.
- ♦ Level 2 — Identifies the various projects, or categories of activity, that must be completed in response to program requirements. Program budgets are usually prepared at this level.
- ♦ Level 3 — Identifies the activities, functions, major tasks, or components of the system that are directly subordinate to the Level 2 items. Program schedules are generally prepared at this level.

Appendix A of MIL-HDBK-881 provides an example of a WBS for an aircraft system as shown in Table 2-2.

Table 2-2
WBS Levels for an Aircraft System

<i>Level 1</i>	<i>Level 2</i>	<i>Level 3</i>
Aircraft System		
	Air Vehicle (AV)	Airframe Propulsion AV Applications Software AV System Software Communications/Identification Navigation/Guidance Central Computer Fire Control Data Display and Controls Survivability Reconnaissance Automatic Flight Control Central Integrated Checkout Antisubmarine Warfare Armament Weapons Delivery Auxiliary Equipment
	Sys Engineering/Program Management	
	System Test and Evaluation	Development Test and Evaluation Operational Test and Evaluation Mock-ups Test and Evaluation Support Test Facilities

<i>Level 1</i>	<i>Level 2</i>	<i>Level 3</i>
	Training	Equipment Services Facilities
	Data	Technical Publications Engineering Data Management Data Support Data Data Depository
	Peculiar Support Equipment	Test and Measurement Equipment Support and Handling Equipment
	Common Support Equipment	Test and Measurement Equipment Support and Handling Equipment
	Operational/Site Activation	System Assembly, Installation and Checkout On-site Contractor Technical Support Site Construction Site/Ship/Vehicle Conversion
	Industrial Facilities	Construction/Conversion/Expansion Equipment Acquisition or Modernization Maintenance (Industrial Facilities)
	Initial Spares and Repair Parts	

In Table 2-2, the highest level of the WBS, Level 1, is an Aircraft System. The next level in the hierarchy, Level 2, comprises subsystems or tasks associated with the Aircraft System, such as the Air Vehicle itself, system test and evaluation, and communications support equipment. Level 3 of the WBS is a breakdown of the Level 2 categories. For example, under the Air Vehicle, Level 3 components include the airframe, propulsion system, and fire control system.

Technical performance measurement

Technical performance measurement (TPM) is another useful tool for managing complex programs. As with the WBS, the DoD has developed excellent references for TPM.

The old MIL-STD-499A (USAF), “Engineering Management,” U.S. Department of Defense, dated May 1, 1974, and the Systems Engineering Fundamentals document, of January 2001, Supplementary Text (www.dau.mil/pubs/gdbks/sys_eng_fund.asp) prepared by the Defense Acquisition University Press, Fort Belvoir, Virginia provide excellent descriptions of TPM. The purposes of TPM are given as follows:

- ♦ Provide visibility of actual vs. planned performance
- ♦ Provide early detection or prediction of problems that require management attention
- ♦ Support assessment of the program impact of proposed change alternatives

MIL-STD-499A also states “TPM assesses the technical characteristics of the system and identifies problems through engineering analyses or tests which indicate performance being achieved for comparison with performance values allocated or specified in contractual documents.”

A TPM integrates the existing cost, schedule and technical performance information that are generated by a program’s prime contractors and other team members.

The Office of the Secretary of Defense (OSD) publication, “Technical Performance Measurement — Integrating Cost, Schedule and Technical Performance for State-of-the-Art Project Management,” graphically depicts TPM as shown in Figure 2-2.

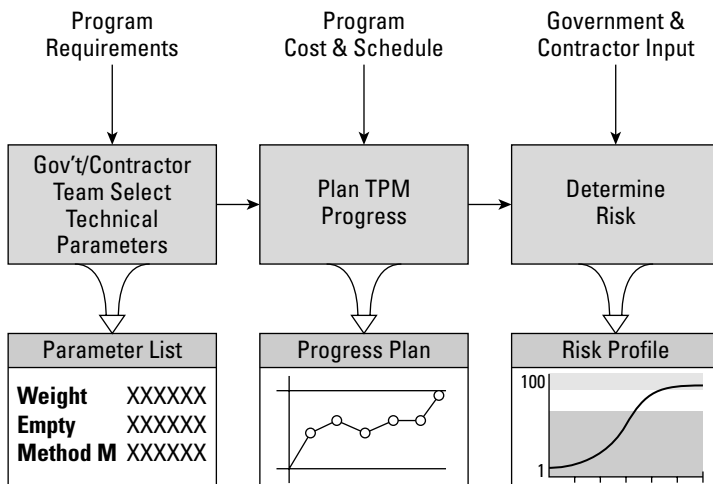

Figure 2-2: Technical performance measurement flow chart

Test and evaluation master plan

The *test and evaluation master plan* (TEMP) provides direction for the technical and management components of the testing effort. The activities involved in producing a TEMP are as follows:

- ♦ Develop a detailed test plan that provides for complete test coverage of the system under test
- ♦ Communicate the nature and extent of the tests
- ♦ Establish an orderly schedule of events
- ♦ Specify organizational and equipment requirements
- ♦ Define the testing methodology
- ♦ Compose a deliverables list
- ♦ Determine the expected outputs
- ♦ Provide instructions for the execution of the tests
- ♦ Maintain a written record of the test inputs
- ♦ Exercise system limits and abnormal inputs

The testing and evaluation activities performed under the TEMP can be separated into different categories, depending on their functions and goals. A summary of these categories is given in Table 2-3.

Table 2-3
Categories of Test and Evaluation

<i>Test and Evaluation Type</i>	<i>Function and Goal</i>
Analytical	Evaluations of design conducted early in the system life cycle using computerized techniques such as CAD, CAM, CALS, simulation, rapid prototyping, and other related approaches.
Type 1 test	The evaluation of system components in the laboratory using bench test models and service test models, designed to verify performance and physical characteristics.
Type 2 test	Testing performed during the latter stages of the detailed design and development phase when preproduction prototype equipment and software are available.
Type 3 test	Tests conducted after initial system qualification and prior to the completion of the production or construction phase. This is the first time that all elements of the system are operated and evaluated on an integrated basis.
Type 4 test	Testing conducted during the system operational use and life-cycle support phase, intended to provide further knowledge of the system in the user environment.

Configuration Management

Configuration management is the process of tracking and approving changes to a system. It involves identifying, controlling, and auditing all changes made to the system. It can address hardware and software changes, networking changes, or any other change affecting security. Configuration management can also be used to protect a trusted system while it is being designed and developed.

The primary security goal of configuration management is to ensure that changes to the system do not unintentionally diminish security. For example, configuration management might prevent an older version of a system from being activated as the production system. Configuration management also makes it possible to accurately roll back to a previous version of a system in case a new system is found to be faulty. Another goal of configuration management is to ensure that system changes are reflected in current documentation to help mitigate the impact that a change might have on the security of other systems, while in either the production or planning stages.

Configuration management is a discipline applying technical and administrative direction to do the following:

- ♦ Identify and document the functional and physical characteristics of each configuration item for the system
- ♦ Manage all changes to these characteristics
- ♦ Record and report the status of change processing and implementation

Configuration management involves process monitoring, version control, information capture, quality control, bookkeeping, and an organizational framework to support these activities. The configuration being managed is the verification system plus all tools and documentation related to the configuration process. In applications development, change control involves the analysis and understanding of the existing code, and the design of changes, and corresponding test procedures.

Primary functions of configuration management

The primary functions of configuration management or change control are as follows:

- ♦ To ensure that the change is implemented in an orderly manner through formalized testing
- ♦ To ensure that the user base is informed of the impending change
- ♦ To analyze the effect of the change on the system after implementation
- ♦ To reduce the negative impact that the change might have had on the computing services and resources

Five generally accepted procedures exist to implement and support the change control process:

1. Applying to introduce a change
2. Cataloging the intended change
3. Scheduling the change
4. Implementing the change
5. Reporting the change to the appropriate parties

Definitions and procedures

The five major components of configuration management and their functions are as follows:

- ♦ Configuration identification
- ♦ Configuration control
- ♦ Configuration status accounting
- ♦ Configuration auditing
- ♦ Documentation change control

These components are explained in the following sections.

Configuration identification

Configuration management entails decomposing the verification system into identifiable, understandable, manageable, trackable units known as *configuration items* (CIs). The decomposition process of a verification system into CIs is called *configuration identification*. A CI is a uniquely identifiable subset of the system that represents the smallest portion to be subject to independent configuration control procedures.

CIs can vary widely in size, type, and complexity. Although no hard-and-fast rules exist for decomposition, the granularity of CIs can have great practical importance. A favorable strategy is to designate relatively large CIs for elements that are not expected to change over the life of the system, and small CIs for elements likely to change more frequently.

Configuration control

Configuration control is a means of ensuring that system changes are approved before being implemented, that only the proposed and approved changes are implemented, and that the implementation is complete and accurate. This activity involves strict procedures for proposing, monitoring, and approving system changes and their

implementation. Configuration control entails central direction of the change process by personnel who coordinate analytical tasks, approve system changes, review the implementation of changes, and supervise other tasks such as documentation.

All analytical and design tasks are conducted under the direction of a corporate entity called the *Configuration Control Board (CCB)*. The CCB is headed by a chairperson who is responsible for ensuring that changes made do not jeopardize the soundness of the verification system and assures that the changes made are approved, tested, documented, and implemented correctly.

The members of the CCB should interact periodically, either through formal meetings or other available means, to discuss configuration management topics such as proposed changes, configuration status accounting reports, and other topics that may be of interest to the different areas of the system development. These interactions should be held to keep the entire system team updated on all advancements to or alterations in the verification system.

Configuration status accounting

Configuration accounting documents the status of configuration control activities and, in general, provides the information needed to manage a configuration effectively. It allows managers to trace system changes and establish the history of any developmental problems and associated fixes. Configuration accounting also tracks the status of current changes as they move through the configuration control process. Configuration accounting establishes the granularity of recorded information and thus shapes the accuracy and usefulness of the audit function. The configuration accounting reports are reviewed by the CCB.

Configuration auditing

Configuration auditing is the quality assurance component of configuration management. It involves periodic checks to determine the consistency and completeness of accounting information and to verify that all configuration management policies are being followed. A vendor's configuration management program must be able to sustain a complete configuration audit by a review team.

Documentation change control

It's important to update all relevant documentation when system changes occur. Such changes could include the following:

- ♦ Changes to the system infrastructure
- ♦ Changes to security policies or procedures
- ♦ Changes to the disaster recovery or business continuity plans
- ♦ Facility environment changes, such as office moves or HVAC and electrical changes

Documentation control is a cornerstone of configuration management. Configuration management specifies strict adherence to documenting system changes, and the process of the documentation itself.

Business Continuity and Disaster Recovery Planning

Business continuity planning addresses the preservation of the business in the face of major disruptions to normal operations. Business continuity includes the preparation, testing, and updating of the actions required to protect critical business processes from the effects of major system and network failures.

A disruptive event is any intentional or unintentional occurrence that suspends normal operations. The aim of business continuity planning is to minimize the effects of a disruptive event on a company. The primary purpose of business continuity plans is to reduce the risk of financial loss and enhance a company's capability to recover from a disruptive event promptly. The business continuity plan should also help minimize the cost associated with the disruptive event and mitigate the risk associated with it.

Disaster recovery planning is concerned with restoring the operation of the business's information systems following a harmful event.

The following definitions clarify some of the relevant terminology:

- ♦ **Contingency plan** — The documented, organized plan for emergency response, backup operations, and recovery maintained by an activity as part of its security program that will ensure the availability of critical resources and facilitates the continuity of operations in an emergency situation.
- ♦ **Disaster recovery plan** — The plan and procedures that have been developed to recover from a disaster that has interfered with the network and other information system operations.
- ♦ **Continuity of operations plan** — The plans and procedures documented to ensure continued critical operations during any period where normal operations are impossible.
- ♦ **Business continuity plan** — The plan and procedures developed that identify and prioritize the critical business functions that must be preserved and the associated procedures for continued operations of those critical business functions.

Business continuity planning

Business continuity plans should evaluate all critical information processing areas of the organization, such as workstations and laptops, networks, servers, application software, storage media, and personnel procedures.

A wide variety of events can impact the operations of a business and the information systems used by that business. These events can be either natural or man-made. Examples of such events include the following:

- ♦ Sabotage
- ♦ Arson
- ♦ Strikes
- ♦ Bombings
- ♦ Earthquakes
- ♦ Fire
- ♦ Floods
- ♦ Fluctuations in or loss of electrical power
- ♦ Storms
- ♦ Communication system failures
- ♦ Unavailability of key employees

Business continuity planning goals and process

The business continuity planning process consists of four major elements:

- ♦ **Scope and plan initiation** — Creating the scope and the other elements needed to define the parameters of the plan.
- ♦ **Business impact assessment** — A process to help business units understand the impact of a disruptive event.
- ♦ **Business continuity plan development** — Developing the business continuity plan. This process includes the areas of plan implementation, plan testing, and ongoing plan maintenance.
- ♦ **Plan approval and implementation** — Final senior management signoff, enterprise-wide awareness of the plan, and implementing a maintenance procedure for updating the plan as needed.

These elements are discussed in more detail in the following sections.

Scope and plan initiation

The scope and plan initiation phase is the first step to creating a business continuity plan. It entails creating the scope for the plan and the other elements needed to

define the parameters of the plan. This phase embodies an examination of the company's operations and support services. Scope activities could include creating a detailed account of the work required, listing the resources to be used, and defining the management practices to be employed.

Business impact assessment

A business impact assessment is a process used to help business units understand the impact of a disruptive event. This phase includes the execution of a vulnerability assessment. A business impact assessment is performed as one step during the creation of the business continuity plan. It is similar to a risk assessment.

The purpose of a business impact assessment is to create a document to be used to help understand what impact a disruptive event would have on the business. The impact might be financial (quantitative) or operational (qualitative, such as the inability to respond to customer complaints).

A business impact assessment has three primary goals:

- ♦ **Prioritization of critical systems**—Every critical business unit process must be identified and prioritized, and the impact of a disruptive event must be evaluated.
- ♦ **Estimation of downtime**—The business impact assessment is used to help estimate the *maximum tolerable downtime* that the business can tolerate and still remain a viable company; that is, what is the longest period of time a critical process can remain interrupted before the company can never recover. It is often found during the business impact assessment process that this time period is much shorter than expected.
- ♦ **Identification of resource requirements**—The resource requirements for the critical processes are identified at this time, with the most time-sensitive processes receiving the most resource allocation.

A business impact assessment is usually conducted in the following manner:

1. **Gather the appropriate assessment materials**—The business impact assessment process begins with identifying the critical business units and their interrelationships. Additional documents might also be collected in order to define the functional interrelationships of the organization.

As the materials are collected and the functional operations of the business are identified, the business impact assessment will examine these business function interdependencies with an eye toward several factors, such as the business success factors involved, establishing a set of priorities between the units, and what alternate processing procedures can be utilized.

2. **Perform the vulnerability assessment**—The vulnerability assessment usually comprises quantitative (financial) and qualitative (operational) sections. The vulnerability assessment is smaller than a full risk assessment and is focused on providing information that is used solely for the business continuity plan or

disaster recovery plan. A key function of a vulnerability assessment is to conduct a loss impact analysis.

Quantitative loss criteria include:

- Incurring financial losses from loss of revenue, capital expenditure, or personal liability resolution
- The additional operational expenses incurred due to the disruptive event
- Incurring financial loss from resolution of violation of contract agreements
- Incurring financial loss from resolution of violation of regulatory or compliance requirements

Typical qualitative loss criteria comprise:

- The loss of competitive advantage or market share
- The loss of public confidence or credibility, or incurring public embarrassment

The vulnerability assessment should address critical support functions such as the physical infrastructure, accounting, payroll, and telecommunications systems.

3. Analyze the compiled information—Analyzing the information as part of the business impact assessment includes:

- Identifying interdependencies
- Documenting required processes
- Determining acceptable interruption periods

4. Document the results; present recommendations—All processes, procedures, analyses, and results should be document and presented to management, including associated recommendations.

The report will contain the previously gathered material, list the identified critical support areas, summarize the quantitative and qualitative impact statements, and provide the recommended recovery priorities generated from the analysis.

Business continuity plan development

The *business continuity plan* is developed by using the information collected in the business impact assessment to create the recovery strategy plan to support the critical business functions. This process includes the areas of plan implementation, plan testing, and ongoing plan maintenance.

Plan approval and implementation

The object of this activity is to obtain the final senior management signoff, creating enterprise-wide awareness of the plan, and implementing a maintenance procedure for updating the plan as needed.

- ♦ **Senior management approval**—Because senior management is ultimately responsible for all phases of the business continuity plan, they must have final approval. When a disaster strikes, senior management must be able to make informed decisions quickly during the recovery effort.
- ♦ **Plan awareness**—Enterprise-wide awareness of the plan is important and emphasizes the organization's commitment to its employees. Specific training may be required for certain personnel to carry out their tasks, and quality training is perceived as a benefit that increases the interest and the commitment of personnel in the business continuity planning process.
- ♦ **Plan maintenance**—Because of uncontrollable events, such as reorganization, employee turnover, relocation, or upgrading of critical resources, a business continuity plan might become outdated. Whatever the reason, plan maintenance techniques must be employed from the outset to ensure that the plan remains fresh and usable. It's important to build maintenance procedures into the organization by using job descriptions that centralize responsibility for updates. Also, audit procedures should be put in place that can report regularly on the state of the plan.

Roles and responsibilities

The business continuity planning process involves many personnel from various parts of the enterprise. Creation of a business continuity planning committee represents the first enterprise-wide involvement of the major critical functional business units. All other business units will be involved in some way later, especially during the implementation and awareness phases.

- ♦ **The business continuity planning committee**—A business continuity planning committee should be formed and given the responsibility to create, implement, and test the plan. The committee is made up of representatives from senior management, all functional business units, information systems, and security administration. The committee initially defines the scope of the plan, which should deal with how to recover promptly from a disruptive event and mitigate the financial and resource loss due to a disruptive event.
- ♦ **Senior management**—Senior management has the ultimate responsibility for all phases of the plan, which includes not only initiation of the plan process but also monitoring and management of the plan during testing and supervision and execution of the plan during a disruptive event. This support is essential, and without management being willing to commit adequate tangible and intangible resources, the plan will not be successful.

Because of the concept of due diligence, stockholders might hold senior managers as well as the board of directors personally responsible if a disruptive event causes losses that adherence to base industry standards of due care could have prevented. For this reason and others, it is in the senior managers' best interest to be fully involved in the business continuity planning process.

Disaster recovery planning

Disaster recovery planning is concerned with the protection of critical business processes from the effects of major information system and network failures, by quickly recovering from an emergency with a minimum impact to the organization.

Goals

A disaster recovery plan is a comprehensive statement of consistent actions to be taken before, during, and after a disruptive event that causes a significant loss of information systems resources.

Disaster recovery plans are the procedures for responding to an emergency, providing extended backup operations during the interruption, and managing recovery and salvage processes afterwards, should an organization experience a substantial loss of processing capability. Another objective of a properly executed disaster recovery plan is to provide the capability to implement critical processes at an alternate site and return to the primary site and normal processing within a time frame that minimizes the loss to the organization.

Disaster recovery process

The disaster recovery planning process involves developing the disaster recovery plan, testing the plan, and executing it in the event of an emergency.

Developing the disaster recovery plan

This first step involves developing the recovery plans and defining the necessary steps required to protect the business in the event of a disaster.

Automated tools are available to assist in the development of the disaster recovery plan. These tools can improve productivity by providing formatted templates customized to the particular organization's needs.

Determining recovery time objectives

Early in the disaster recovery planning process, all business functions and critical systems must be examined to determine their recovery time requirements. Recovery time objectives are assigned to each function or system in order to guide the selection of alternate processing procedures. Table 2-4 summarizes the rating classes and associated recovery time frame objectives.

Table 2-4
Recovery Time Frames

<i>Rating Class</i>	<i>Recovery Time Frames</i>
AAA	Immediate
AA	Full functional recovery within 4 hours
A	Same business day
B	Up to 24 hours down time permitted
C	24 to 72 hours down time acceptable
D	Greater than 72 hours down time acceptable

Establishing backup sites

An important component of disaster recovery planning is maintaining a backup site that provides some degree of duplication of computing resources located away from the primary site. The types of backup sites are differentiated primarily by the extent to which the primary computing resources are replicated.

Hot sites, *warm sites*, and *cold sites* are the most common types of remote off-site backup processing facilities. They are differentiated by how much preparation is devoted to the site and, therefore, how quickly the site can be used as an alternate processing site. The characteristics of each of these sites are given as follows:

- ♦ **Cold site** — A designated computer operations room with HVAC that has no computing systems installed and, therefore, would require a substantial effort to install the hardware and software required to begin alternate processing. This type of site is rarely useful in an actual emergency.
- ♦ **Warm site** — An alternate processing facility with most supporting peripheral equipment, but without the principal computing platforms.
- ♦ **Hot site** — A site with all required computer hardware, software, and peripherals installed to begin alternate processing either immediately or within an acceptably short time frame. This site would be a duplicate of the original site and might only require an upgrade of the most current data to duplicate operations.

Additional options for providing backup capabilities include the following:

- ♦ **Mutual aid agreements** — An arrangement with another company that might have similar computing needs. Both parties agree to support each other in the case of a disruptive event by providing alternative processing resources to the other party. While appealing, this is not a good choice if the emergency affects both parties. Also, capacity at either facility might not be available when needed.

- ♦ **Rolling or mobile backup**—Contracting with a vendor to provide mobile power and HVAC facilitates sufficient to stage the alternate processing.
- ♦ **Multiple centers**—In a multiple-center concept, the processing is spread over several operations centers, creating a distributed approach to redundancy and sharing of available resources. These multiple centers could be owned and managed by the same organization (in-house sites) or used in conjunction with a reciprocal agreement.
- ♦ **Service bureaus**—An organization might contract with a service bureau to fully provide alternate backup-processing services. The advantages of this type of arrangement are the quick response and availability of the service bureau, the possibility of testing without disrupting normal operations, and the service bureau may be available for more additional support functions. The disadvantages of this type of setup are the expense and resource contention during a large emergency.

Plan testing

The disaster recovery plan must be tested and evaluated at regular intervals. Testing is required to verify the accuracy of the recovery procedures, verify the processing capability of the alternate backup site, train personnel, and identify deficiencies. The most common types of testing modes, by increasing level of thoroughness, are as follows:

- ♦ **Checklist review**—The disaster recovery plan is distributed and reviewed by business units for its thoroughness and effectiveness.
- ♦ **Tabletop exercise or structured walk-through test**—Members of the emergency management group meet in a conference room setting to discuss their responsibilities and how they would react to emergency scenarios by stepping through the plan.
- ♦ **Walk-through drill or simulation test**—The emergency management group and response teams actually perform their emergency response functions by walking through the test, without actually initiating recovery procedures. This approach is more thorough than the table-top exercise.
- ♦ **Functional drill**—This approach tests specific functions, such as medical response, emergency notifications, warning and communications procedures, and equipment, although not necessarily all at once. It also includes evacuation drills, where personnel walk the evacuation route to a designated area where procedures for accounting for the personnel are tested.
- ♦ **Parallel test or full-scale exercise**—A real-life emergency situation is simulated as closely as possible. It involves all of the participants that would be responding to the real emergency, including community and external organizations. The test may involve ceasing some real production processing.
- ♦ **Full-interruption test**—Normal production is shut down and the disaster recovery processes are fully executed. This type of test is dangerous and, if not properly executed, can cause a disaster situation.

Implementing the plan

If an actual disaster occurs, there are three options for recovery:

1. Recover at the primary operating site
2. Recover to an alternate site for critical functions
3. Restore full system after a catastrophic loss

Two teams should be organized to execute the recovery, the *recovery* and *salvage* teams. The functions of these teams are as follows:

- ♦ **The recovery team**—Restore operations of the organization's critical business functions at the alternate backup processing site. The recovery team is concerned with rebuilding production processing.
- ♦ **The salvage team**—Repair, clean, salvage, and determine the viability of the primary processing infrastructure immediately after the disaster.

The disaster recovery plan should also address other concerns such as paying employees during a disaster, preventing fraud, media relations, and liaison with local emergency services.

Physical Security

Physical security is concerned with the protection of personnel, sensitive information, facilities, and equipment through the use of physical controls. Safeguards such as fencing, lighting, guard dogs, biometrics for identification, closed-circuit television, and physical lockdown devices are examples of physical control measures.

Threats to physical security include the following:

- ♦ Vandalism
- ♦ Sabotage
- ♦ Loss of electrical power
- ♦ Environmental conditions
- ♦ Strikes
- ♦ Natural disasters
- ♦ Water damage
- ♦ Toxic material release
- ♦ Earthquakes
- ♦ Extremes of temperature and humidity
- ♦ Smoke particles

To protect the confidentiality, integrity, and availability of networks and associated information systems, controls are implemented in accordance with cost considerations and best practices.

Controls

Controls in physical security can be partitioned into physical, technical, and administrative types. These types of controls complement each other in providing effective protections for network security.

Physical controls

Physical controls are the most familiar types of controls. They usually control access and involve traditional deterrent items such as guards, lighting, fences, motion detectors, and so on. These types of controls are listed as follows:

- ♦ **Guards**—Guards can apply human judgment to interpret sensor presentations in addition to providing deterrent, response, and control capabilities.
- ♦ **Dogs**—Dogs are used primarily for perimeter physical control.
- ♦ **Fencing**—Fencing is the primary means of perimeter/boundary facility access control. Fences deter casual trespassing by controlling access to entrances.
- ♦ **Mantrap**—A mantrap is a physical access control method where the entrance to a facility or area is routed through a set of double doors. One door must be closed for the next door to open. It may or may not be monitored by a guard.
- ♦ **Lighting**—Protective lighting of entrances or parking areas can discourage prowlers or casual intruders. Common types of lighting include floodlights, streetlights, Fresnel lights, and searchlights.
- ♦ **Locks**—Locks can be divided into two types: preset and programmable.
 - **Preset locks**—Preset locks include key-in-knob, mortise, and rim locks. These all consist of variations of latches, cylinders, and dead bolts.
 - **Programmable locks**—These locks can be either mechanically or electronically based. A mechanical programmable lock is often a typical dial combination lock. Another type of mechanical programmable lock is the common five-key push-button lock that requires the user to enter a combination of numbers. This is a very popular lock for IT operations centers. An electronic programmable lock requires the user to enter a pattern of digits on a numerical-style keypad, and it may display the digits in random order each time to prevent shoulder surfing for input patterns. It is also known as a cipher lock or keypad access control.
- ♦ **Closed-circuit television**—Visual surveillance or recording devices such as closed-circuit television are used in conjunction with guards in order to enhance their surveillance ability and to record events for future analysis or prosecution.

- ♦ **Perimeter intrusion detectors**—The two most common types of physical perimeter detectors are based either on photoelectric sensors or dry contact switches.
 - **Photoelectric sensors**—Photoelectric sensors receive a beam of light from a light-emitting device, creating a grid of either visible white light, or invisible infrared light. An alarm is activated when the beams are broken. The beams can be physically avoided if seen; therefore, invisible infrared light is often used.
 - **Dry contact switches**—Dry contact switches and tape are probably the most common types of perimeter detection. This can consist of metallic foil tape on windows or metal contact switches on doorframes.
- ♦ **PC physical controls**—Because of the proliferation of distributed computing and particularly, laptops, inventory control for PCs is critical. Controls that address this issue include the following:
 - **Cable locks**—A cable lock consists of a vinyl-covered steel cable anchoring the PC or peripherals to the desk. They often consist of screw kits, slot locks, and cable traps.
 - **Port controls**—Port controls are devices that secure data ports (such as a floppy drive or a serial or parallel port) and prevent their use.
 - **Switch control**—A switch control is a cover for the on/off switch, which prevents a user from switching off the file server's power.
 - **Peripheral switch controls**—These types of controls are lockable switches that prevent a keyboard from being used.

Technical controls

Technical controls supplement physical and administrative controls and are typically used in highly secure facilities. Examples of technical controls are smart cards and biometric devices.

Smart Cards

A smart card used for access control is also called a security access card. This card comprises the following types:

- ♦ **Photo-image cards**—Photo-image cards are simple identification cards with the photo of the bearer for identification.
- ♦ **Digital-coded cards**—Digitally encoded cards contain chips or magnetically encoded strips (possibly in addition to a photo of the bearer). The card reader may be programmed to accept or deny entry based on an online access control computer that can also provide information about the date and time of entry. These cards may also be able to create multi-level access groupings.
- ♦ **Wireless proximity readers**—A proximity reader does not require the user to physically insert the access card. This card may also be referred to as a wireless security card. The card reader senses the card in possession of a user in the general area (proximity) and enables access.

Biometric devices

Biometric access control devices are technical applications in physical security. Biometric technologies can be used for identification or authentication.

The following are typical biometric characteristics used to uniquely identify or authenticate an individual:

- ♦ Fingerprints
- ♦ Retina scans
- ♦ Iris scans
- ♦ Facial scans
- ♦ Palm scans
- ♦ Hand geometry
- ♦ Voice
- ♦ Handwritten signature dynamics

Administrative controls

Administrative controls are related to personnel and facility issues. They include emergency procedures, personnel control, planning, and policy implementation.

Administrative controls are comprised of the following:

- ♦ Administrative personnel controls
- ♦ Facility planning
- ♦ Facility security management

Administrative personnel controls

Administrative personnel controls include personnel-related processes commonly applied during employee hiring and firing. Examples of these controls include the following:

- ♦ Pre-employment screening, including employment, references, or educational history checks, and background investigation or credit-rating checks for sensitive positions
- ♦ Ongoing employee checks, such as security clearances, generated only if the employee is to have access to classified documents, and employee ratings or reviews by his or her supervisor
- ♦ Post-employment procedures such as exit interviews, removal of network access and change of passwords, and return of company equipment, including magnetic media, documents, and computer upon termination

Understanding Biometrics

Biometrics are used for identification in physical access control, and for authentication in technical (logical) access control. In biometrics, *identification* is a one-to-many search of an individual's characteristics from a database of stored images. *Authentication* in biometrics is a one-to-one search to verify a claim to an identity made by a person. The three main performance measures in biometrics are as follows:

- ♦ False rejection rate (FRR), or Type I error – The percentage of valid subjects that are falsely rejected
- ♦ False acceptance rate (FAR), or Type II error – The percentage of invalid subjects that are falsely accepted
- ♦ Crossover error rate (CER) – The percent in which the FRR equals the FAR

In most cases, the sensitivity of the biometric detection system can be increased or decreased during an inspection process. If the system's sensitivity is increased, such as in an airport metal detector, the system becomes increasingly selective and has a higher FRR. Conversely, if the sensitivity is decreased, the FAR will increase.

Other important factors that must be evaluated in biometric systems are enrollment time, throughput rate, and acceptability. *Enrollment time* is the time it takes to initially register with a system by providing samples of the biometric characteristic to be evaluated. An acceptable enrollment time is around two minutes.

The *throughput rate* is the rate at which individuals, once enrolled, can be processed and identified or authenticated by a system. Acceptable throughput rates are in the range of 10 subjects per minute.

Acceptability refers to considerations of privacy, invasiveness, and psychological and physical comfort when using the system. For example, one concern with retina scanning systems may be the exchange of body fluids on the eyepiece. Another concern would be the retinal pattern that could reveal changes in a person's health, such as the advent of diabetes or high blood pressure.

Acquiring different data elements reflecting a biometric characteristic can greatly affect the storage requirements and operational speed of a biometric identification or authentication system. For example, in *fingerprint* systems, the actual fingerprint is stored and requires approximately 250kb per finger for a high-quality image. This level of information is required for one-to-many searches in forensics applications on very large databases. In *finger-scan* technology, a full fingerprint is not stored – the features extracted from this fingerprint are stored using a small template that requires approximately 500 to 1000 bytes of storage. The original fingerprint cannot be reconstructed from this template. Finger-scan technology is used for one-to-one verification using smaller databases. Updates of the enrollment information may be required because some biometric characteristics, such as voice and signature, can change with time.

Facility planning

Facility planning is concerned with issues such as location of the facility, visibility of the facility, neighboring buildings and tenants, access to emergency services, and environmental considerations.

Facility security management

Facility security management includes the application of audit trails and emergency procedures. An audit trail is a record of events, such as the date and time of the access attempt, whether the attempt was successful or not, where the access was granted, who attempted the access, and who modified the access privileges at the supervisor level

Audit trails contain critical information and should be protected at the highest level of security in the system. Audit trails serve to assist in determining the nature of the intrusion and tracking down the intruder after the fact.

Environmental issues

Clean, steady power is required to maintain the proper personnel environment as well as to sustain data operations. Many elements can threaten power systems, the most common being noise, brownouts, and humidity.

Electrical power

Electrical power systems service many different types of devices, ranging from electric motors to computers. Devices such as motors, computers, and radio transmitters superimpose fluctuations of different frequencies on the power line. These disturbances are referred to as electromagnetic interference and radio frequency interference. Electromagnetic interference usually refers to noise from motors and radio frequency interference refers to adverse interference caused by radio waves.

Interference on power lines can be reduced or eliminated by shielding data cables, proper grounding, and putting equipment containing motors on separate transformers than those supplying sensitive computers and related equipment.

**Note**

As one example of such guidelines, the United States government created the TEMPEST standard to prevent electromagnetic interference eavesdropping by employing heavy metal shielding. TEMPEST is a classified program, and official information on the topic is difficult to obtain. However, there have been reports written on the fundamentals of TEMPEST. One such document is Technical Report Number 577, Cambridge University Computer Laboratory, UCAM-CL-TR-577, ISSN 1476-2986, entitled “Compromising Emanations: Eavesdropping Risks of Computer Displays” by Markus G. Kuhn (www.cl.cam.ac.uk/).

Humidity

Humidity is critical to the operation of electronic components. If the humidity is too high, condensation will cause corrosion and possibly short circuits on printed circuit

boards. Conversely, if the moisture content in the air is too low, high static charges can build up and, when discharged, can damage circuit components. The ideal operating humidity range is defined as 40 percent to 60 percent humidity.

Humidity can be controlled through the use of anti-static floor mats and anti-static sprays.

Fire suppression

Fire can obviously affect the operation of an information system. As with any other emergency, the safety of personnel is paramount. Preservation of data and system components should only be considered after the safe evacuation of personnel.

Fires are categorized into different classes as a function of the type of combustible material and the extinguishing agents. This information is summarized in Table 2-5.

<i>Class</i>	<i>Description</i>	<i>Suppression Medium</i>
A	Common combustibles	Water or soda acid
B	Liquid	CO ₂ , soda acid, or Halon
C	Electrical	CO ₂ or Halon

A fire requires a fuel source, oxygen, and heat. From Table 2-5, soda acid suppresses the fuel source, water reduces the temperature, CO₂ suppresses the oxygen supply, and Halon suppresses combustion through a chemical reaction.

Examples of the National Fire Protection Association (NFPA) fire class ratings are given in Table 2-6.

<i>Fire Class</i>	<i>Combustible Materials</i>
A	Wood, cloth, paper, rubber, most plastics, ordinary combustibles
B	Flammable liquids and gases, oils, greases, tars, oil-base paints and lacquers
C	Energized electrical equipment
D	Flammable chemicals such as magnesium and sodium

Fire extinguishing systems

Fires can be extinguished by means of gas discharge or water sprinkler systems. The characteristics of these systems are shown in Table 2-7.

Table 2-7
Types of Fire Extinguishing Systems

<i>Type</i>	<i>Operation</i>
Wet pipe	Water resides in a pipe under pressure and is released by a fusible link in the nozzle that melts if the temperature exceeds 165° F.
Dry pipe	Water is held back from the nozzle by a clapper valve. In the event of a fire, the clapper valve opens, air is discharged from the pipe, and the water emerges after a time delay. This delay allows some time to power down computer systems before they are inundated with water.
Deluge	Similar to a dry pipe system, but designed to discharge a much larger volume of water.
Preaction	Combines the clapper valve of a dry pipe system with the heat-sensitive nozzle of the wet pipe system.
Gas discharge	Uses an inert gas to retard combustion and the gas is usually delivered from under a raised floor. CO ₂ is one of the gases used. Halon was also popular, but because of personnel safety and environmental issues, Halon substitutes are required for new installations.

Object reuse and data remanence

Object reuse refers to using data that was previously recorded on a storage medium. For example, a zip disk loaned to someone might contain your bank records. A related concept is having data remain on a storage medium after you think it has been erased. This phenomenon is called data remanence. Data can be removed from storage media by destroying the media, degaussing the media with a magnetic field, sometimes referred to as purging, and overwriting the media with other non-critical information. With the latter method, it is sometimes necessary to overwrite the data many times to ensure complete protection of the original information.

Legal and Liability Issues

The field of investigating computer crime, or *computer forensics*, is the collecting of information from and about computer systems that is admissible in a court of law. To address computer crime, many jurisdictions have expanded the definition of property to include electronic information.

Types of computer crime

Computer crimes range from applying social skills to obtain passwords to critical information systems to flooding servers with so many connection requests that the servers are overwhelmed. Table 2-8 provides examples of the different types of computer crimes.

Table 2-8
Examples of Types of Computer Crimes

Crime	Activity
Social engineering	Applying social skills to trick people so as to obtain information, such as passwords or PIN numbers, to be used in an attack against computer-based systems. The book, <i>The Art of Deception: Controlling the Human Element of Security</i> by Kevin D. Mitnick, William L. Simon, and Steve Wozniak provides detailed insight to the field of malicious social engineering.
Network intrusions	Obtaining unauthorized access to networked computers.
Illegal content of material	Downloading pornographic material or sending offending e-mails.
Denial of service (DoS) and distributed denial of service (DDoS)	Flooding an information system with vast numbers of requests for service to the point where the information system cannot respond and is consuming so many resources that normal processing cannot occur.
Malicious code	Code such as viruses, Trojan horses, and worms that infect a computer and negatively affect its operation.

Infamous Computer Crimes

The following are some of the better-known examples of computer crimes:

- ♦ The 2003 Sapphire or Slammer worm and the 2001 Code Red worm that randomly searched for IP addresses to infect.
- ♦ The 2002 Klez worm, alias Elkern, Klaz, or Kletz worm contained hidden messages aimed at anti-virus researchers.
- ♦ The 2000 distributed denial-of-service attacks perpetrated against Amazon.com and Yahoo!.

Electronic monitoring

A gray area is the right of an employer to monitor an employee's computer communications or that of an outsider accessing an organization's computer network. An organization can be on firmer legal ground if it frequently and unambiguously notifies all who access the network that their activities are subject to monitoring. This notification can take the form of a logon banner that states that by logging on to the system, the individual consents to electronic monitoring and is subject to a predefined punishment if the system is used for unlawful activities or if the user violates the organization's information security policy. It should also state that unauthorized access and use of the system is prohibited and subject to punishment. It is important that the notification and monitoring is uniformly applied to all employees.

Liability

Upper management of an organization is ultimately responsible for protecting the organization's intellectual property. Best practices require that management apply the *prudent man rule* that "requires officers to perform duties with diligence and care that ordinary, prudent people would exercise under similar circumstances." The officers must exercise *due care or reasonable care* to carry out their responsibilities to the organization. Examples of due care include ensuring the proper information security controls are in place and functioning, appropriate security policies exist and are applied, business continuity plans have been developed, and appropriate personnel screening is conducted.

The criteria for evaluating the legal requirements for implementing safeguards is to evaluate the cost (C) of instituting the protection versus the estimated loss (L) resulting from exploitation of the corresponding vulnerability. If $C < L$, then a legal liability exists.

Summary

Managing information system security proceeds from the top down. Senior management must generate, distribute, and enforce the organization's information security policy. An important aspect of the policy is that the appropriate personnel are trained to be security aware and understand the policy requirements. When a policy and the associated procedures are in place, management tools should be applied to ensure the resulting corporate products meet their quality requirements. A component of the corporate policy is the DRP/BCP plan that maintains the continuity of the operation of the organization in the event of a disaster.

Another component of managing security is the implementation of appropriate physical security measures to protect the organization's information systems. Organizational management must understand the responsibilities and liabilities associated with their role in ensuring that the organization's intellectual property is not compromised.



Access Control Considerations

Controlling access to a network and its associated resources is the cornerstone of network security. In today's distributed computing environment, where large amounts of computing power and sensitive intellectual property reside on individuals' desks, access control is crucial to any organization.

This chapter describes models used to categorize access controls, the different types of controls, and means for providing for secure and verifiable local and remote login.

Control Models

Access control is designed to mitigate access-related vulnerabilities that could be exploited by threats to a network. A *threat* is an event or activity that has the potential to cause harm to the network. In this case, the threat would have the potential to bypass or foil access control mechanisms and allow an attacker to gain unauthorized access to a network. A *vulnerability* is a weakness that can be exploited by a threat, causing harm to the network. The probability that a threat will materialize and result in harm to the network is defined as *risk*. In discussing access control, the terms subject and object are used. A *subject* is an active entity (such as an individual or process) and an *object* is a passive entity (such as a file).

Access control models can be classified as discretionary, mandatory, and non-discretionary.

Discretionary access control

An authorizing entity or the subject has authority, within certain limitations, to specify the objects that can be accessed. One means of specifying discretionary access control is



In This Chapter

Understanding the different access control models

Understanding the different access control types

Defining identification, authentication, and authorization

Reviewing databases and database security

Implementing remote access



through a table. The table contains the subjects, objects, and access privileges that are assigned to the subjects relative to the objects. This table is sometimes called an *access control list* (ACL). Table 3-1 is an example of an ACL.

<i>Subject</i>	<i>Object 1</i>	<i>Object 2</i>	<i>Object 3</i>
	File Salary	File Benefits	Process Evaluation
Program salary	Read/write	Read	Execute
Ms. Jones	None	Read	None
Mr. Tops	Read/write	Read/write	None
Process average	Read/write	Read	None

Table 3-1 shows that the program named Salary can read or write data from the file named Salary and has read privileges for the file named Benefits. Also, the program Salary can execute the process called Evaluate.

A user that has the right to alter the access privileges to certain objects operates under *user-directed* discretionary access control. Another discretionary access control type based on an individual's identity is known as *identity-based* access control.

Mandatory access control

In mandatory access control, means must be found to formally match the authorizations allocated to the subject to the sensitivity of the objects that are the target of the access request. One approach is to use *labels*. The subject's authorization can be in the form of a *clearance* that is to be compared to *classification* of the object. In the United States, the military classifies documents as unclassified, confidential, secret, and top secret. Similarly, an individual can receive a clearance of confidential, secret, or top secret, and can have access to documents classified at or below his or her specified clearance level. Thus, an individual with a secret clearance can access secret and confidential documents, but with a restriction called the *need to know*. Need to know means that the subject must have a need to access the requested classified document to perform its assigned duties. *Rule-based access control* is a type of mandatory access control in that rules determine the access privileges (such as the correspondence of clearance labels to classification labels), rather than the identity of the subjects and objects alone.

Non-discretionary access control

In *non-discretionary access control*, access privileges might be based on the individual's role in the organization (*role-based*) or the subject's responsibilities and duties (*task-based*). Role-based access control is often used in an organization where there are frequent personnel changes to eliminate the need to change privileges whenever a new person takes over that role.

Access control can also be characterized as context-dependent or content-dependent. *Context-dependent access control* is a function of factors such as location, time of day, and previous access history. It is concerned with the environment or context of the data. In *content-dependent access control*, access is determined by the information contained in the item being accessed.

Types of Access Control Implementations

Access controls are used to prevent attacks, to determine if attacks have occurred or been attempted, and to bring the network back to its pre-attack state if an attack was successful. These three types of controls are called *preventive*, *detective*, and *corrective*, respectively. To affect these controls, administrative, technical (logical), and physical means are employed. *Administrative controls* include activities such as creating policies and procedures, security awareness training, and background checks. *Technical (logical) controls* involve the use of approaches that include encryption, smart cards, and transmission protocols. *Physical controls* are more familiar and comprise guards, building security, and securing laptops. By joining the control types and implementation means, different control combinations are obtained. Examples of the key combinations are listed in the following sections.

Preventive/Administrative

Preventive and administrative controls include the following:

- ♦ Organizational policies and procedures
- ♦ Background checks
- ♦ Employee termination procedures
- ♦ Employment agreements
- ♦ Security awareness training
- ♦ Labeling of sensitive materials
- ♦ Vacation scheduling

Preventive/Technical

Preventive and technical controls apply technology to prevent violations of an organization's security policy. Technical controls are also known as logical controls and can be built into the operating system, can be software applications, or can be supplemental hardware or software units. Examples of preventive and technical controls include the following:

- ♦ Protocols
- ♦ Biometrics for authentication
- ♦ Encryption
- ♦ Smart cards
- ♦ Menus
- ♦ Constrained user interfaces
- ♦ Passwords
- ♦ Limited keypads

In the preceding list, constrained user interfaces limit the functions available to a user, for example, by “graying out” choices on the user menu that cannot be selected. Similarly, limited keypads restrict the choice of functions to those available on the keys provided.

Preventive/Physical

This category is concerned with restricting physical access to areas with systems holding sensitive information. Preventive and physical controls include the following:

- ♦ Guards
- ♦ Man-trap (consists of two doors physically separated so that an individual can be “trapped” in the space between the doors after entering one of the doors)
- ♦ Fences
- ♦ Biometrics for identification
- ♦ Environmental controls (temperature, humidity, electrical)
- ♦ Badges

Detective/Administrative

Detective and administrative controls comprise the following:

- ♦ Audit record review
- ♦ Sharing of responsibilities

- ♦ Organizational policies and procedures
- ♦ Background checks
- ♦ Vacation scheduling
- ♦ Labeling of sensitive materials
- ♦ Behavior awareness

Detective/Technical

Detective and technical controls apply technical means to identify the occurrence of an intrusion or other violations of an organization's security policy. These measures include the following:

- ♦ **Intrusion detection systems (IDSs)**— These devices are characterized by the technology used to detect an intrusion or its location. For example, a host-based ID system resides on a centralized host and performs well in detecting attacks on the host. However, this type of IDS is not effective in detecting network intrusions. Conversely, a network-based IDS is a passive detector of real-time intrusions and consumes fewer resources than a host-based IDS. IDSs detect intrusions by two principal methods. One approach is to profile a “normal” usage state for a network or host and then detect deviations from this state. The other approach is to acquire “signatures” of attacks and then monitor the system for these signatures when an attack occurs.
- ♦ **Violation reports generated from audit trail information** — These reports can indicate variations from “normal” operation or detect known signatures of unauthorized access episodes. *Clipping* or threshold levels can be employed to limit the amount of audit information flagged and reported by automated violation analysis and reporting mechanisms. Clipping levels can set a threshold on the number of occurrences of an event, below which the event is not reported.

Detective/Physical

Detective and physical controls normally require a human to evaluate the input from sensors for a potential threat. Examples of these types of control mechanisms include:

- ♦ Video cameras
- ♦ Motion detectors
- ♦ Thermal detectors

Centralized/Decentralized access controls

Centralized access control is usually characterized by centrally managed resources and knowledgeable professionals with experience in the various types of control mechanisms. Centralized access control systems and protocols, such as RADIUS and TACACS+, are discussed later in this chapter.

On the other hand, decentralized access controls are closer to the user and, consequently, should reflect the users' concerns and requirements. A paradigm for decentralized access control is the establishment of *security domains*, in which participants are under the same management and follow common security policies.

Decentralized systems have the need for strong access control. An example would be an organization using the World Wide Web to facilitate communications and cooperation among its subentities. Generally, these systems exhibit the following characteristics:

- ♦ Encryption of passwords and Ids.
- ♦ Formal access control rules.
- ♦ Each subentity authenticates its respective clients.
- ♦ Additional subentities can be added to the network.

Identification and Authentication

Identification is the act of a user professing an identity to a system, usually in the form of a logon ID. Identification establishes user accountability for his or her actions on the system. *Authentication* is verification that the user's claimed identity is valid, and it is usually implemented through a user password at logon time. Authentication is provided through a variety of means from secret passwords to using biometric characteristics. In general, authentication is accomplished by testing one or more of the following items:

- ♦ Something you know, such as a personal identification number (PIN) or password; this factor is known as Type 1 authentication.
- ♦ Something you have, such as an ATM card or smart card; this factor is known as Type 2 authentication.
- ♦ Something you are (physically), such as a fingerprint or retina scan; this factor is known as Type 3 authentication.

Obviously, using more than one factor adds additional credence to the authentication process. For example, *two-factor authentication* refers to using two of the three factors, such as a PIN number (something you know) in conjunction with an ATM card (something you have).

After authentication, a user is granted rights and permissions to access certain computer resources and information. This allocation is known as *authorization* of the user.

Passwords

Passwords are, by far, the most popular factor used for authentication. Therefore, protecting passwords from compromise and unauthorized use is crucial.

Similar to a one-time pad in cryptography, a *one-time password* provides the highest level of password security. Because a new password is required every time a user logs on to the network, an attacker cannot use a previously compromised password. A password that changes frequently is called a *dynamic password*. A password that is the same for each logon is called a *static password*. An organization can require that passwords change monthly, quarterly, or at other intervals, depending on the sensitivity of the protected information and the password's frequency of use.

In some instances, a passphrase can be used instead of a password. A *passphrase* is a sequence of characters that is usually longer than the allotted number of characters for a password. The passphrase is converted into a virtual password by the system.

Passwords can be generated automatically by credit card–sized memory cards, smart cards, or devices resembling small calculators. Some of these devices are referred to as *tokens*. These password generators are Type 2 devices, something you have.

Biometrics

Biometrics is defined as an automated means of identifying or authenticating the identity of a living person based on physiological or behavioral characteristics. Biometrics is a Type 3 authentication mechanism because it is based on what a person “is.” Biometrics is useful in both identification and authentication modes.

For identification, biometrics is applied as a *one-to-many* search of an individual's characteristics from a database of stored characteristics of a large population. An example of a one-to-many search is trying to match a suspect's fingerprints to a database of fingerprints of people living in the United States. Conversely, authentication in biometrics is a *one-to-one* search to verify a claim to an identity made by a person. An example of this mode is matching an employee's fingerprints against the previously registered fingerprints in a database of the company's employees. Relative to access control, biometrics is used for identification in physical controls and for authentication in logical controls.

Performance measures of a biometric system range from technical characteristics to employees “feeling comfortable” with their use. Examples of performance measures follow:

- ♦ **Type I Error or False Rejection Rate (FRR)**— The percentage of valid subjects that are falsely rejected.
- ♦ **Type II Error or False Acceptance Rate (FAR)**— The percentage of invalid subjects that are falsely accepted.
- ♦ **Crossover Error Rate (CER)**— The percent in which the FRR equals the FAR. The smaller the CER, the better the biometric system.
- ♦ **Enrollment time**— The time that it takes to initially “register” with a system by providing samples of the biometric characteristic to be evaluated. An acceptable enrollment time is around two minutes.
- ♦ **Throughput rate**— The rate at which the system processes and identifies or authenticates individuals. Acceptable throughput rates are in the range of 10 subjects per minute.
- ♦ **Acceptability**— The considerations of privacy, invasiveness, and psychological and physical comfort when using the system. For example, a concern with retina scanning systems might be the exchange of body fluids on the eye-piece. Another concern would be the retinal pattern, which could reveal changes in a person’s health, such as the onset of diabetes or high blood pressure.

The following are typical biometric characteristics:

- ♦ Retina scans
- ♦ Iris scans
- ♦ Fingerprints
- ♦ Facial scans
- ♦ Palm scans
- ♦ Hand geometry
- ♦ Voice
- ♦ Handwritten signature dynamics

Single Sign-On

In Single Sign-On (SSO), a user provides one ID and password per work session and is automatically logged on to all the required network resources and applications. Without SSO, a user normally must enter multiple passwords to access different network resources. In applying SSO, passwords should be transmitted or stored in encrypted form for security purposes. With SSO, network administration is simplified, a stronger password can be used, and resources can be accessed in less time.

The major disadvantage of many SSO implementations is that once a user obtains access to the system through the initial logon, the user can freely roam the network resources without any restrictions.

SSO can be implemented in the following ways:

- ♦ Through scripts that replay the users' multiple logins.
- ♦ Through Enterprise Access Management (EAM). EAM provides access control management services, including SSO, to Web-based enterprise systems. In one approach, SSO is implemented on Web applications residing on different servers in the same domain by using nonpersistent, encrypted cookies on the client interface.
- ♦ Using authentication servers to verify a user's identity and encrypted authentication tickets to permit access to system services.

A popular authentication server approach that can implement SSO is the Kerberos system.

Kerberos

Kerberos is named after a three-headed dog that guards the entrance to the underworld in Greek mythology. Kerberos is based on symmetric key cryptography and was developed under Project Athena at the Massachusetts Institute of Technology. It is a trusted, third-party authentication protocol that authenticates clients to other entities on a network and provides secure means for these clients to access resources on the network.

Kerberos assumes that client computers and network cables are publicly accessible in insecure locations. Thus, messages transmitted on a Kerberos network can be intercepted. However, Kerberos also assumes that some specific locations and servers can be secured to operate as trusted authentication mechanisms for every client and service on that network. These centralized servers implement the Kerberos-trusted Key Distribution Center (KDC), Kerberos Ticket Granting Service (TGS), and Kerberos Authentication Service (AS). The basic principles of Kerberos operation are summarized as follows:

1. The KDC knows the secret keys of all clients and servers on the network.
2. The KDC initially exchanges information with the client and server by using these secret keys.
3. Kerberos authenticates a client to a requested service on a server through the TGS and by issuing temporary symmetric session keys for communications between the client and KDC, the server and the KDC, and the client and server.
4. Communication then takes place between the client and the server by using those temporary session keys.

A Kerberos exchange begins with a user entering his or her password into a Kerberos client workstation. The user's password is then converted to the user's secret key in the workstation. This secret key resides temporarily on the workstation. Then, the client transmits the user's ID in unencrypted form to the Ticket Granting Service, as illustrated in Figure 3-1.

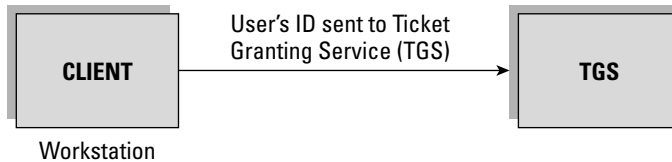

Figure 3-1: Initial client to TGS exchange

In response, the TGS sends the client a TGS-client session key, $K_{tgs,c}$, encrypted with the user's secret key. In addition, the TGS also sends a ticket granting ticket (TGT) encrypted with a key known only to the TGS. This exchange is shown in Figure 3-2.

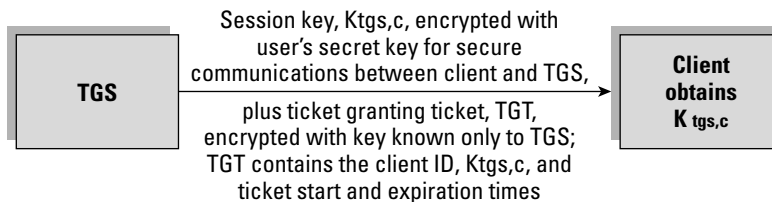

Figure 3-2: TGS and client session key/TGT exchange

Upon receipt of these messages, the client decrypts $K_{tgs,c}$ with the user's secret key. For this example, the user is requesting access to a print server, PS. So, the client sends a request to the TGS for a print server ticket. This request, shown in Figure 3-3, comprises an authenticator, A , and time stamp, both encrypted with $K_{tgs,c}$ and the TGT encrypted with the key known only to the TGS.

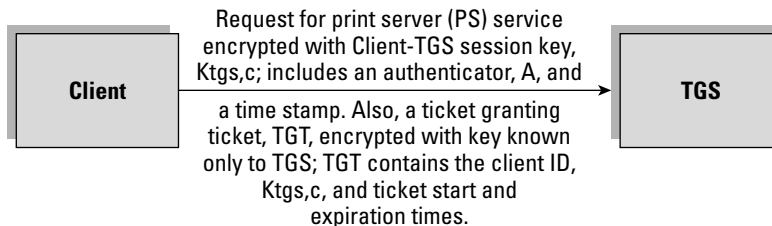

Figure 3-3: Client to TGS request for PS ticket

In the next step of the sequence, the TGS transmits a client-print server session key, $K_{c,ps}$, to the client. This session key is encrypted with the key $K_{tgs,c}$. The TGS also sends the client a ticket for the print server encrypted with a key known only to the print server. This communication is illustrated in Figure 3-4.

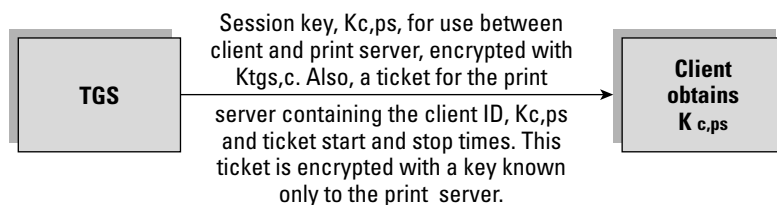

Figure 3-4: TGS to client print server session key transmission

To access the print server, the client sends the time-stamped authenticator, A , encoded with $K_{c,ps}$, to the print server. The client also transmits the ticket encoded with a key known only to the print server. The print server decodes the ticket and obtains $K_{c,ps}$, the client-print server session key. The print server then uses $K_{c,ps}$ to communicate securely with the client. Figure 3-5 shows this exchange.

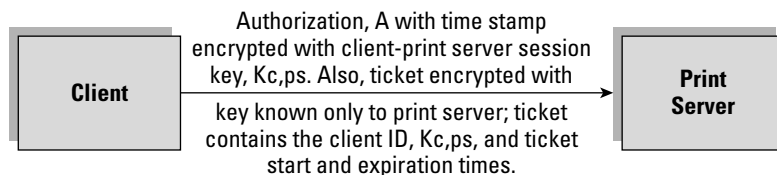

Figure 3-5: Client to print server service exchange

The primary goal of Kerberos is to protect the confidentiality and integrity of information. Because of the exposure and vulnerability of the workstations and network cables, it does not directly address availability. Because all the secret keys of the clients and other network resources are stored at the KDS and TGS, these servers are vulnerable to attacks and are a potential single point of failure. Replay can be accomplished on Kerberos if the compromised tickets are used within an allotted time window. Also, because a client's password is used to initiate a Kerberos authentication exchange, Kerberos is vulnerable to guessing of passwords. Similarly, because a client's secret key is stored temporarily on the client workstation, the secret key is subject to possible compromise.

SESAME

With the advent of public key cryptography, a common paradigm is to use a public key cryptosystem to securely transmit the secret keys to be used in symmetric key cryptosystems. This hybrid approach is used by another SSO implementation, the Secure European System for Applications in a Multivendor Environment (SESAME). SESAME uses the Needham-Schroeder public key authentication protocol and a trusted authentication server at each host to reduce the key management requirements. SESAME also incorporates two certificates or tickets that provide for authentication and access privileges. SESAME is also subject to password guessing.

KryptoKnight

As with Kerberos, the IBM KryptoKnight SSO system uses a trusted KDC that stores the network users' secret key. One of the differences between Kerberos and KryptoKnight is that there is a peer-to-peer relationship among the parties and the KDC in KryptoKnight. To implement SSO, there is an initial exchange from the user to the KDC comprising the user's name and a value, which is a function of a *nonce* (a randomly-generated, one-time use authenticator) and the password. The KDC authenticates the user and sends the user a ticket encrypted with the user's secret key. The user decrypts this ticket and can use it for authentication to obtain services from other servers on the system.

Databases

Another access control means is the application of database technology to screen the information available to a variety of users. In particular, the relational model developed by E. F. Codd of IBM (circa 1970) is useful in network security applications.

Relational databases

A relational database model comprises data structures in the form of tables and relations, integrity rules on allowable values in the tables, and operators on the data in the tables. A *database* can formally be defined as a persistent collection of interrelated data items. Persistency is obtained through the preservation of integrity and through the use of nonvolatile storage media. The following terms describe some of the different database attributes:

- ♦ **Schema**— The description of the database.
- ♦ **Data Description Language (DDL)**— Defines the schema.
- ♦ **Database management system (DBMS)**— The software that maintains and provides access to the database. Relative to access control, a particular user can be restricted to certain information in the database and will not be allowed to view any other information.

- ♦ **Relation**—A two-dimensional table that serves as the basis of a relational database. The rows of the table represent *records* or *tuples*, and the columns of the table represent the *attributes*.
- ♦ **Cardinality**—The number of rows in the relation.
- ♦ **Degree**—The number of columns in the relation.
- ♦ **Domain**—The set of allowable values that an attribute can take in a relation.

In a relation, a unique identifier or *primary key* unambiguously points to an individual tuple or record in the table. If an attribute in one relation has values matching the primary key in another relation, this attribute is called a *foreign key*. A foreign key does not have to be the primary key of its containing relation.

Example relational database operations

A number of operations in relational algebra are used to build relations and operate on the data. The following items are examples of relational database operations:

- ♦ **Select**—Defines a new relation based on a formula
- ♦ **Union**—Forms a new relation from two other relations
- ♦ **Join**—Selects tuples that have equal numbers for some attributes

An important database operation related to controlling the access of database information is the *View*. A View does not exist in a physical form, and it can be considered a virtual table that is derived from other tables. (A relation that actually exists in the database is called a *base relation*.) These other tables could be tables that exist within the database or previously defined Views. Views can be used to restrict access to certain information within the database, to hide attributes, and to implement content-dependent access restrictions. So, an individual requesting access to information within a database will be presented with a View containing the information that the person is allowed to see. The View hides the information that individual is not allowed to see. In this way, the View can be thought of as implementing Least Privilege.

In statistical database queries, a protection mechanism used to limit inferencing of information is the specification of a minimum query set size, but prohibiting the querying of all but one of the records in the database. This control thwarts an attack of gathering statistics on a query set size M , equal to or greater than the minimum query set size, and then requesting the same statistics on a query set size of $M + 1$. The second query set would be designed to include the individual whose information is being sought surreptitiously. When querying a database for statistical information, individually identifiable information should be protected. Requiring a minimum size for the query set (greater than one) offers protection against gathering information on one individual.

Data Normalization

Normalization is an important part of database design that ensures that attributes in a table depend only on the primary key. This process makes it easier to maintain data and to have consistent reports. Normalizing data in the database consists of three steps:

- ♦ Eliminating any repeating groups by putting them into separate tables
- ♦ Eliminating redundant data (occurring in more than one table)
- ♦ Eliminating attributes in a table that are not dependent on the primary key of that table

Other database types

Relational databases have been extensively researched for network security applications and are well suited to textual applications. Other database types are useful for multimedia and textual, multimedia, or security applications. Two of these types are summarized in the following sections.

Object-oriented databases

Object-oriented databases (OODB) are useful in applications involving multimedia, computer-aided design, video, graphics, and expert systems. An OODB has the following positive and negative characteristics:

- ♦ Ease of reusing code and analysis
- ♦ Places no restrictions on the types or sizes of data elements, as is the case with relational databases
- ♦ Reduced maintenance
- ♦ Easier transition from analysis of the problem to design and implementation
- ♦ A steep learning curve
- ♦ A high overhead of hardware and software required for development and operation.

Object-relational databases

The object-relational database combines the features of object-oriented and relational databases. The object-relational model was introduced in 1992 with the release of the UniSQL/X unified relational and object-oriented database system. Hewlett Packard then released OpenODB (later called Oadapter), which extended its AllBase relational Database Management System.

Remote Access

Authentication, authorization, and accounting are important requirements during a remote access session. A number of services and protocols are used to provide these capabilities. These services and protocols are discussed in the following sections.

RADIUS

A central authentication service for dial-up users is the standard Remote Authentication and Dial-In User Service (RADIUS). RADIUS incorporates an authentication server and dynamic passwords. The RADIUS protocol is an open, lightweight, UDP-based protocol that can be modified to work with a variety of security systems. It provides authentication, authorization, and accounting services to routers, modem servers, and wireless applications. RADIUS is described in RFC 2865.

Radius comprises the following three principal components:

- ♦ **A network access server (NAS)**—Processes connection requests and initiates an access exchange with the user through protocols such as the Point-to-Point Protocol (PPP) or the Serial Line Internet Protocol (SLIP). This activity produces the username, password, NAS device identifier, and so on. The NAS sends this information to the RADIUS server for authentication. The user password is protected by encryption in protocols such as the Password Authentication Protocol (PAP) or the Challenge Handshake Authentication Protocol (CHAP).
- ♦ **Access client**—A device (router) or individual dialing into an ISP network to connect to the Internet.
- ♦ **The RADIUS server**—Compares the NAS information with data in a trusted database to provide authentication and authorization services. The NAS also provides accounting information to the RADIUS server for documentation purposes.

TACACS and TACACS+

Terminal Access Controller Access Control System (TACACS) is an authentication protocol that provides remote access authentication and related services, such as event logging. In a TACACS system, user passwords are administered in a central database rather than in individual routers, which provides an easily scalable network security solution. A TACACS-enabled network device prompts the remote user for a user name and static password, and then the TACACS-enabled device queries a TACACS server to verify that password. TACACS does not support prompting for a password change or for the use of dynamic password tokens. TACACS has been superseded by TACACS+, which provides for dynamic passwords, two-factor authentication, and improved audit functions.

TACACS + is composed of the following elements, which are similar to those of RADIUS:

- ♦ **Access client**—A person or device, such as a router, that dials in to an ISP.
- ♦ **A network access server (NAS)**—A server that processes requests for connections. The NAS conducts access control exchanges with the client, obtaining information such as password, user name, and NAS port number. Then, this data is transmitted to the TACACS+ server for authentication.
- ♦ **The TACACS+ server**—A server that authenticates the access request and authorizes services. It also receives accounting and documentation information from the NAS.

Password Authentication Protocol

Another authentication mechanism is the Password Authentication Protocol (PAP). In PAP, a user provides an unencrypted user name and password, which are compared with the corresponding information in a database of authorized users. Because the user name and password are usually sent in the clear, this method is not secure and is vulnerable to an attacker who intercepts this information. PAP is described in RFC 1334.

In operation, after a communication link is established between the remote user and PAP, a user ID and password are transmitted repeatedly until authentication is completed or the communication is terminated.

PAP is vulnerable to ID and password guessing and to replay attacks.

An improved approach is the Challenge Handshake Authentication Protocol.

Challenge Handshake Authentication Protocol

The Challenge Handshake Authentication Protocol (CHAP), described in RFC 1994, provides authentication after the establishment of the initial communication link between the user and CHAP. CHAP operation comprises a three-way handshaking procedure summarized in the following steps:

1. The CHAP authentication mechanism sends a “challenge” to the user following the establishment of the communication link.
2. The user responds to the challenge with a string produced by a one-way hash function.

3. The hash value transmitted by the user is compared with a hash result calculated by the authentication mechanism. If the two hash values are identical, authentication of the user is verified. If the values do not match, the connection is terminated.
4. For increased security, Steps 1 through 3 are repeated at random time periods. This procedure provides protection against replay attacks.

Callback

Yet another method of remote authentication is Callback. In Callback, a remote user dials in to the authentication server, provides an ID and password, and then hangs up. The authentication server looks up the caller's ID in a database of authorized users and obtains a phone number at a fixed location. (Note that the remote user must be calling from that location.) The authentication server calls the phone number, the user answers, and then the user has access to the system. In some Callback implementations, the user must enter another password upon receiving a Callback. The disadvantage of this system is that the user must be at a fixed location whose phone number is known to the authentication server. A threat to Callback is that a cracker can arrange to have the call automatically forwarded to their number, enabling access to the system.

Summary

Access controls are crucial in protecting the network and its associated resources. In establishing an access control architecture, it is useful to limit the number of areas of administration. SSO environments, such as Kerberos and SESAME, support this concept. Mandatory access control paradigms are particularly useful in protecting information and preventing major compromises of intellectual property.

Databases are another important tool in providing access controls and implementing the concept of least privilege through database Views. Remote access systems and protocols, such as RADIUS and CHAP, provide secure means for authenticating supplicants through the use of dynamic passwords and challenge-response procedures.



Operating Systems and Applications

P A R T

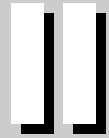

In This Part

Chapter 4
Windows Security

Chapter 5
UNIX and Linux
Security

Chapter 6
Web Browser and
Client Security

Chapter 7
Web Security

Chapter 8
E-mail Security

Chapter 9
Domain Name
System

Chapter 10
Server Security



Windows Security

Windows security is an important component to the overall security of a network or enterprise. The Windows workstation holds a critical position in a defense-in-depth strategy. Figure 4-1 illustrates the defense-in-depth strategy.

Defense-in-depth is a general methodology to slow down and obstruct an attacker. Defense-in-depth can also reduce the damage that occurs from an attack or other security incident. Should any one security control (defense) fail, defense-in-depth slows an attacker down by ensuring that there are still more obstacles in the way. This approach might give administrators time to discover and react to the threat. The “onion” shown in Figure 4-1 has the following layers of protection:

- ◆ **Managing users** — The vigilance and security awareness of users can be crucial to all the other security controls being effective.
- ◆ **Harden hosts** — Default features are prime targets for attackers and always make the Top 10 on vulnerability lists.
- ◆ **Virtual local area network (VLAN) separation** — Trust but separate; no one aside from payroll personnel and administrators has a need to be able to reach payroll workstations.
- ◆ **Server separation** — Provide a place of enhanced security for high-value targets.
- ◆ **Wide area network (WAN) separation** — Establish need-to-know or need-to-access criteria between hosts and servers.
- ◆ **Customer separation** — Assume that any users and hosts outside of an organization’s control are insecure.
- ◆ **Internet perimeter** — The Internet contains many threats, but the FBI finds that most attacks come from the inside.

CHAPTER 4



In This Chapter

Out-of-the-box operating system hardening

Installing applications

Putting the workstation on the network

Operating Windows safely

The importance of upgrades and patches

Maintaining and testing security

Known attacks against Windows workstations



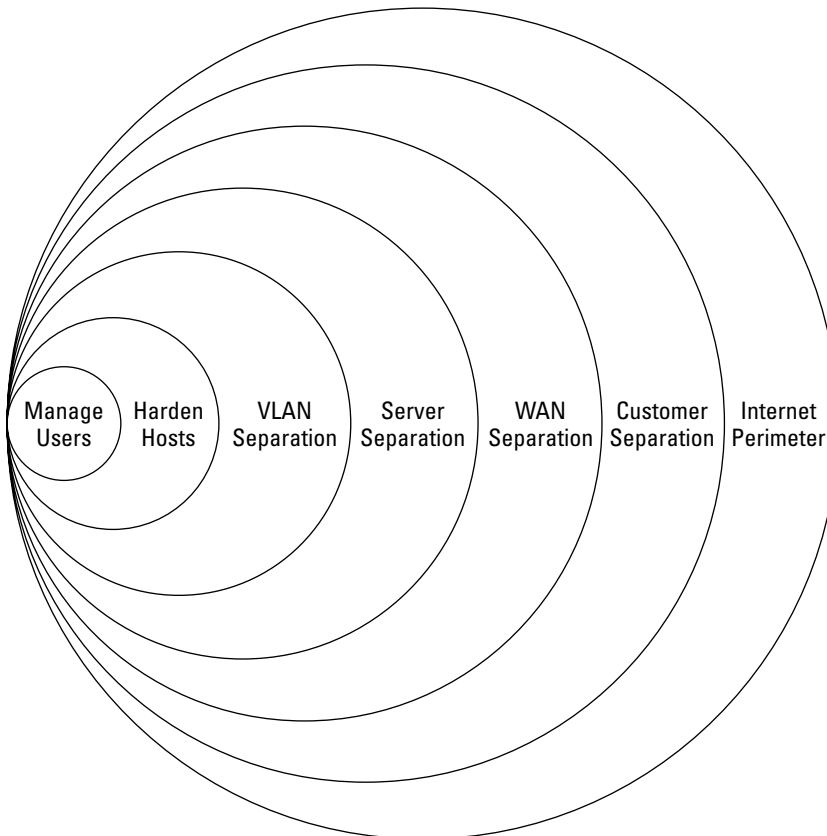

Figure 4-1: Defense-in-depth methodology

Defense-in-depth can also serve to discourage an attacker. Attackers will take the path of least resistance. Many attacks are opportunistic. The attacker sees a vulnerability and explores it. In such cases, the attacker will pursue the attack until resistance is met. If the attacker then senses that there will be little resistance (no defense-in-depth), they may be motivated to continue. If, on the other hand, the attacker meets resistance and difficulty, they may abandon the attack and seek easier prey.

Defense-in-depth also reduces the number of successful attackers. With defense-in-depth, the attacker must be knowledgeable and able to execute several attacks. This requirement eliminates the threat from the largest group of attackers, *script kiddies*. Script kiddies are generally recognized as immature, anarchist hackers that acquire tools developed by knowledgeable hackers. The script kiddies could not develop these tools or even execute the attack manually. However, they are capable of running the tools and causing damage. Most of these tools target a single vulnerability or flaw. Script kiddies are not proficient at stringing tools together, so they are often thwarted by defense-in-depth.

Windows Security at the Heart of the Defense

All attacks will require that the perpetrator must affect a networked device. In most cases, this device is a host or server. Securing the Windows operating system should be considered as important as any other security control, such as a firewall.

Because most work is typically done on the Windows workstation, it is often configured for ease-of-use. There is a natural trade-off between ease-of-use and security. The easier a system or application is to use, the less secure it will be. This trade-off is illustrated in Figure 4-2. If an attacker has made it as far as a user's Windows machine, there is a good chance the attack will be successful.

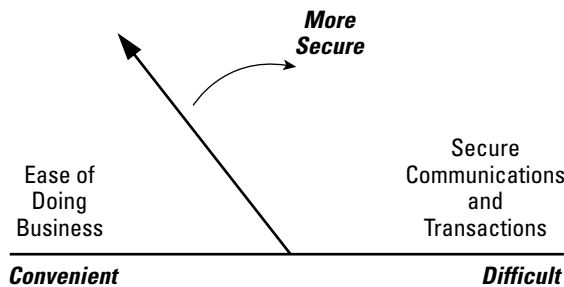

Figure 4-2: The trade-off between convenience and security

Who would target me?

If you have chosen to make Windows your dominant platform, you can count yourself among the vast majority of computer users. That in itself does not make you a target for attack. However, the smart business approach that Microsoft has taken may not lead to the best security for you. When you purchase your Windows product, it will most likely do what you want it to do. Overall, the purchase will be a pleasant experience, and this is a great business approach for Microsoft.

Another good business move by Microsoft is to make the product very easy to install. Windows requires very little information for the initial installation. Older versions of Windows 95 and Windows NT required some technical knowledge for selecting options, but the newer versions of Windows require less knowledge about how computers work while installing.

But there is a price to be paid for easy installation of an off-the-shelf product. The product has many features that you probably do not need.

Windows features that the user does not use but that do not impact system performance do not, at first, appear to be a problem. In fact, in the vast majority of cases, no thought is given to configuring the operating system after the initial installation.

Most users are obviously happy, having just experienced an easy installation and seeing that the system does everything that they expected.

The security problem is that these circumstances, a very large installation base, and a feature-rich default installation, feed right into the hands of the hackers. The hackers purchase and install the very same Windows as their future victims. They know that if they find a vulnerability, they will have potentially millions of workstations to try to exploit. The hackers also know that most users will settle for the default installation of Windows, leaving most features enabled.

This situation all leads up to Windows being the most targeted operating system for hackers. It is a debate in the security community as to which operating systems have the most published vulnerabilities. However, it is agreed that an out-of-the-box installation of Windows will be attacked and compromised in short order, depending, of course, on the network to which it is attached.

Be afraid . . .

It is a dangerous and cruel world out there. Most of us seek out safe havens in our communities, at home, and at work. However, we still lock our cars and our front doors.

Consider your Windows workstation an entry point for the outside world to get into your safe haven. Consider some of the ramifications of having such easy access to the outside world:

- ♦ Credit card data could be stolen and used.
- ♦ Private data could be stolen and used for identity theft.
- ♦ Private e-mail could be read by strangers or by colleagues at work.
- ♦ Pornographic and undesirable material, which would never be allowed in the home or workplace, could be put on the workstation.
- ♦ Complete strangers could learn information about your family and children. Such information could lure your children into a “trust” situation.
- ♦ Viruses and worms may annoy your friends and colleagues, damaging your personal and professional reputation.
- ♦ The Windows system could be used to attack and damage others, perhaps leaving you liable.

You would never let a criminal or con artist into your home to look through private papers. The same level of concern and protection should be extended to a Windows workstation.

It is common to hear potential victims say, “I have nothing important to lose on that system.” That is a false sense of security. Be paranoid and avoid the risk.

Microsoft recommendations

Microsoft, on its official Web site at www.microsoft.com/security/protect, recommends the following three steps to improving a computer's security:

1. Use an Internet firewall.
2. Get computer updates.
3. Use up-to-date antivirus software.

Microsoft recommends either a hardware or software firewall to “prevent hackers, and many types of viruses and worms, from accessing your computer.” This chapter discusses additional ways to protect against these threats.

Microsoft also recommends a daily update using the automatic update feature available in Windows 2000 Service Pack 3 or later. This chapter will discuss the need to keep all applications updated, as well as some associated steps such as testing and backups.

Microsoft suggests getting antivirus software from Computer Associate, McAfee Security, or Symantec, keeping it up-to-date, and configuring it properly. This chapter further expands on these recommendations.

These are important steps to maintaining the security of a Windows workstation. This chapter will discuss many more steps that can be taken to secure a Windows workstation.

The following recommendations are in support of hardening systems on the network:

- ♦ Establish a plan to harden any host that will interact with the outside world, including placing the Windows workstation on a local area network (LAN) or sharing files with other computers. It is most important to develop a procedure that is kept up-to-date. Many points will be learned along the way and it is important that these be noted and get incorporated into the procedures. Each time you harden a system, it will go quickly and smoothly. This is assumed to take 50 hours.
- ♦ Never put an out-of-the-box operating system on a LAN other than a very secure test LAN. Original equipment manufacturers (OEMs) prepare Windows workstations for a wide audience. An organization needs to have systems stripped down to the minimal needed for the business to be done.
- ♦ Never put a Windows workstation that has previously been on the Internet on a trusted LAN. Any host that has been unprotected on the Internet for more than an hour should be considered suspect and corrupted. If placed on a trusted LAN, it will pose a risk to all the other workstations. Any Windows system that has been on the Internet, unprotected, should be completely rebuilt before being put into a trusted environment.

- ♦ Turn off unneeded ports on the Windows workstation. Numerous tools, such as nmap, are available to check the open ports by scanning from the network. On the Windows workstation, run **netstat -a** from a command prompt will list the open ports.
- ♦ Turn off unneeded services on the Windows workstation, even if these services do not open ports onto the network.
- ♦ Use the Microsoft update site to determine the recommended patches and upgrades to the Windows operating system.
- ♦ Install and maintain a good antivirus application.
- ♦ Put personal firewalls on the Windows workstations. This is a good defense-in-depth deterrent for attackers. Free versions are available such as ZoneAlarm by Zone Labs or Tiny Firewall by Tiny Software.
- ♦ Do not run high-visibility services (Web, mail, file sharing, information sharing—LDAP, FTP) on the Windows workstation without a business case. A review of all such services running should be done to determine their need. Any that are not needed should be shut down or disabled.
- ♦ Do not use services that have reliable secure versions. For example, use SSH for Telnet, IMAP instead of POP3, and secure FTP for FTP.
- ♦ Identify mission-critical applications and maintain the security patches and upgrades for these applications.
- ♦ Establish a program to scan the Windows workstation periodically to determine what ports are open and why. Optimally, the workstation should be checked quarterly.
- ♦ Use strong passwords. Change the password frequently—every 60 days or sooner is recommended.
- ♦ Operate safely. Don't open or launch any application that you are not 100 percent sure about. Don't open e-mails from strangers. Don't open any e-mail attachment you do not expect ahead of time. Remove unneeded data and history files from the workstation. Use encryption.
- ♦ Watch for performance issues. If metrics are not in place to notice performance, put them in place.
- ♦ Run a host-based intrusion detection system (HIDS) on critical Windows workstations. The HIDS will detect unauthorized activity on the host as well as raise the alarm if certain files are changed. The costly part of running an HIDS is the learning curve. Because each site's administrators will manage their own HIDS systems, this learning curve is repeated several times. The learning curve continues because the HIDS must be monitored and adjusted on the installed servers. It is expected that the administrators will spend a couple of hours a week working with the HIDS.

Out-of-the-Box Operating System Hardening

This section examines steps to improve the security of a Windows system, prior to putting the workstation on the network.

Prior to system hardening

Physically disconnect the workstation from any network. Out-of-the-box installations of Windows are so prominently targeted that a new system can be compromised in a matter of minutes, or even seconds — far too fast for an administrator to harden the system.

If reinstalling Windows on an existing workstation, be certain to back up your data. Back up to external media or to a different hard drive or partition. Most people back up their data files, such as letters and photos. It is also important to capture some other information while the system is still functioning. Consider the following, for example:

- ♦ Write down the type of video card and how much memory it has.
- ♦ Record the network interface card (NIC) type and any TCP/IP settings. If using wireless, record the service set identifier (SSID) and any encryption keys.
- ♦ Check dialup connections for phone numbers.
- ♦ Go into the Web browser and save the bookmarked pages.
- ♦ Record printer configuration settings.
- ♦ Record any types and configurations for other hardware such as sound cards, Web cameras, or scanners.

The general process of system hardening

No matter which Windows version you are dealing with, the general process for hardening the operating system and workstation is the same. The process is as follows.

- ♦ Assess and understand the role of the Windows workstation to be hardened. This entails understanding the users and their responsibilities. It also involves knowing where on the network the workstation will be placed.
- ♦ Acquire hardening procedures for other Windows workstations that have a similar role. If prior procedures are not available, get a listing of applications and settings on a similar workstation (*winmsd.exe* provides a good starting point). There are many hardening guides available to assist an administrator in the hardening of their operating system. These guides offer an administrator a step-by-step procedure for securing the workstation. They also assist network administrators by offering a repeatable process so that steps are not missed.

- ♦ Install a clean version of the operating system; then document the changes and burn a ghost image.
- ♦ Remove some services that are not required; then document the changes and burn another ghost image.
- ♦ If at any point, the system becomes unusable, which should be expected, drop back to the most recent ghost image and try again. However, this time, do not remove the service that caused the problem.
- ♦ Remove any extra applications that may have been loaded with the Windows operating system, then document the changes and burn another ghost image.
- ♦ Check and close any ports that are not explicitly required for performing the mission of this workstation. Open ports can be detected by opening a command prompt window and running **netstat -an**. Any protocol listed in the results that shows a status of “LISTENING” has an open port.
- ♦ Locate and close any shares that are not explicitly required by the role that this workstation will have. Open shares can be listed by opening a command prompt window and running **net share**. This will list the share name and the resource (folder) being shared. You can disable sharing through the Windows Explorer by clicking on the properties of the folder.
- ♦ Install only the needed applications, document the changes, and burn a final ghost image.
- ♦ Install a personal firewall on the Windows workstation.
- ♦ Thoroughly test the system.

It is important to document every step of the system hardening for both successes and failures. If failures occur, usually in the form of the system crashing or hanging, it is important to know exactly what was done so the procedure can be altered. The most common failure will be a result of a needed service having been disabled or removed.

It is also important to document the case when the system hardening goes successfully. A detailed procedure for how to harden a system for a particular organization or user will be very useful when adding future systems to the inventory. A Web search will produce a number of sets of procedures for hardening various Windows operating systems. Many colleges and universities provide this information, primarily trying to reach their student population, but they make the information available to the public in the process.

By now, you should see the need to have frequent ghost images. The relatively short delay taken to burn a ghost image will be more than recouped the first time the system crashes and needs to be rebuilt. The ghosting application makes a compressed snapshot of the partition on the hard drive. This snapshot or image can either be burned to a CD-RW disk, or put on another hard drive partition.

It is important to thoroughly test the system once it has been hardened. The final configuration is, in all likelihood, not one that has been tested by Microsoft. In fact, the combination of services and applications needed might be unique to your organization.

You can obtain a list of Windows services using the net command. The following results from opening a command prompt and running **net start**:

```
Alerter
Automatic Updates
COM+ Event System
Computer Browser
DHCP Client
Distributed Link Tracking Client
DNS Client
Event Log
IPSEC Policy Agent
Logical Disk Manager
Messenger
Network Connections
PGPsdService
PGPService
Plug and Play
Print Spooler
Protected Storage
Remote Access Connection Manager
Remote Procedure Call (RPC)
Remote Registry Service
Removable Storage
RunAs Service
Security Accounts Manager
Server
System Event Notification
Task Scheduler
TCP/IP NetBIOS Helper Service
Telephony
VMware Tools Service
Windows Management Instrumentation
Windows Management Instrumentation Driver Extensions
Workstation
```

The command completed successfully.

Windows 2003 new installation example

Here is an example of a typical out-of-the-box installation of Windows 2003 Enterprise Edition. No special features were installed. This was the baseline installation, and the workstation might be used for anything from simply a word processing station to an

Internet gaming workstation. Six ports were found open on the new installed system using nmap and nessus. Scanners found the following information:

```
The 65530 ports scanned but not shown below are in state:
closed
Port      Service
135/tcp   loc-srv
137/udp   netbios-ns
139/tcp   netbios-ssn
445/tcp   microsoft-ds
1025/tcp  NFS-or-IIS
1026/tcp  LSA-or-nterm
```

The following list breaks down the port information discovered during the scan in detail:

- ♦ **Port 135 - loc-srv/epmap**— Microsoft Data Circuit-Terminating Equipment (DCE) Locator service aka end-point mapper. It works like Sun Remote Procedure Call (RPC) portmapper, except that end points can also be named pipes. Microsoft relies upon DCE RPC to manage services remotely. Some services that use port 135 of end-point mapping are Dynamic Host Configuration Protocol (DHCP), Domain Name System (DNS), and Windows Internet Name Service (WINS) servers. The remote host is running a version of Windows that has a flaw in its RPC interface, which may allow an attacker to execute arbitrary code and gain SYSTEM privileges. An attacker or a worm could use it to gain the control of this host. Note that this may not be the same bug as the one described in MS03-026, which fixes the flaw exploited by the MSBlast (or LoveSan) worm. DCE services running remotely can be enumerated by connecting on port 135 and doing the appropriate queries. An attacker may use this fact to gain more knowledge about the remote host. The scanners provide the following additional information:
 - **Solution:** see www.microsoft.com/technet/security/bulletin/MS03-039.asp
 - **Solution:** see www.microsoft.com/technet/security/bulletin/MS03-026.asp
- ♦ **Port 139 - NetBIOS Session (TCP)**— Windows File and Printer Sharing. A Server Message Block (SMB) server is running on this port. This is the single most dangerous port on the Internet. All File and Printer Sharing on a Windows machine runs over this port. About 10 percent of all users on the Internet leave their hard disks exposed on this port. This is the first port hackers want to connect to, and the port that firewalls block.
- ♦ **Port 139 - NetBIOS Session (UDP)**— The remote host is running a version of the NetBT name service that suffers from a memory disclosure problem. An attacker may send a special packet to the remote NetBT name service, and the reply will contain random arbitrary data from the remote host memory.

This arbitrary data may be a fragment from the Web page the remote user is viewing, or something more serious, such as a POP password or anything else. An attacker may use this flaw to continuously poll the content of the remote host's memory and might be able to obtain sensitive information.

- ♦ **Port 445**—SMB in Windows 2000. Microsoft has created a new transport for SMB over TCP and UDP on port 445. This replaces the older implementation that was over ports 137, 138, and 139. However, port 139 is still left open on a new installation. A Common Internet File Systems (CIFS) server is running on this port. It was possible to log into the remote host using a NULL session. The concept of a NULL session is to provide a null user name and a null password, which grants the user the guest access. The computer name of the Windows 2003 host was determined through the null session running on this port. This is potentially dangerous as it may facilitate the attack of a potential hacker by giving him extra targets to check for. The scanners provide the following additional information.
 - To prevent null sessions, see MS KB Article Q143474 (NT 4.0) and Q246261 (Windows 2000). Note that this won't completely disable null sessions, but it will prevent them from connecting to IPC\$.
- ♦ **Port 1025**—This is the first dynamically assigned port. Therefore, virtually any program that requests a port can be assigned one at this address. A DCE service is listening on this port. Here is the list of DCE services running on this port:
 - UUID: 12345678-1234-abcd-ef00-0123456789ab, version 1, Endpoint: ncacn_ip_tcp:192.168.1.12[1025] Annotation: IPSec Policy agent endpoint
 - UUID: 12345778-1234-abcd-ef00-0123456789ac, version 1, Endpoint: ncacn_ip_tcp:192.168.1.12[1025]
- ♦ **Port 1026**—This is a dynamically assigned port. Therefore, virtually any program that requests a port can be assigned one at this address. Nmap reports that either a Local Security Authority (LSA) server or the nterm application is running. Here is the list of DCE services running on this port:
 - UUID: 1ff70682-0a51-30e8-076d-740be8cee98b, version 1, Endpoint: ncacn_ip_tcp:192.168.1.12[1026]
 - UUID: 378e52b0-c0a9-11cf-822d-00aa0051e40f, version 1, Endpoint: ncacn_ip_tcp:192.168.1.12[1026]
 - UUID: 0a74ef1c-41a4-4e06-83ae-dc74fb1cdd53, version 1, Endpoint: ncacn_ip_tcp:192.168.1.12[1026]

This example illustrates the inherent problem with out-of-the-box installations of Windows systems. This system was not intended to be used for file sharing or serving up DHCP, NFS, IIS, LSA, or nterm. Yet, apparently, ports are open for these or similar applications.

Specifics of system hardening

The following list itemizes more specific recommendations that can improve the security of a Windows workstation.

- ◆ Enable the built-in Encrypting File System (EFS) with NTFS.
- ◆ Remove Enable LMhosts lookup.
- ◆ Disable NetBIOS over TCP/IP.
- ◆ Remove ncacn_ip_tcp.
- ◆ Set MaxCachedSockets (REG_DWORD) to 0.
- ◆ Set SmbDeviceEnabled (REG_DWORD) to 0.
- ◆ Set AutoShareServer to 0.
- ◆ Set AutoShareWks to 0.
- ◆ For NullSessionPipes delete all value data INSIDE this key.
- ◆ For NullSessionShares delete all value data INSIDE this key.
- ◆ If the workstation has significant random access memory (RAM), disable the Windows swapfile. This will increase performance and security, because no sensitive data can be written to the hard drive.
- ◆ Set specific users to have access to shared folders. This will prevent other users (except administrator) from accessing the shared folder.
- ◆ Set the number of users allowed to access the shared folder to a reasonable number. If the folder is intended to be accessed by only one user, set the number of users to 1.
- ◆ If encryption of folders content is available (as in XP Professional version), use it.
- ◆ Apply appropriate Registry and file system ACLs.
- ◆ Protect the registry from anonymous access.
- ◆ Display legal notice before the user logs in.
- ◆ Set the paging file to be cleared at system shutdown.
- ◆ Set strong password policies.
- ◆ Set account lockout policy.
- ◆ Enable auditing of failed logon attempts and privilege requests.
- ◆ Secure LDAP features.
- ◆ Remove exploitable sample data from IIS.

Do not use AUTORUN

Untrusted code can be run without the direct knowledge of the user. In some circumstances an attacker can put a CD into the machine and cause his own script to run.

File permissions

Another important, and often overlooked, security procedure is to lock down the file-level permissions for the server. By default, Windows does not apply specific restrictions on any of the local files or folders. The Everyone group is given full permissions to most of the machine. To harden the operating system, this group must be removed and only the proper groups and users be given specific access to every file and folder in the operating system.

The Registry

Although changes to Windows are done with the Graphical User Interface (GUI), the changes are really just made in the Registry. Many functions that the Registry performs cannot be manipulated through the Windows GUI. It is essential that the administrator take the time to thoroughly understand how the Registry functions and what functions the different hives and keys perform. Many of the vulnerabilities found in the Windows operating system can be fixed by making changes to specific keys.

File allocation table security

Microsoft Windows has many of its security features enabled out-of-box, but due to the variety of network scenarios, most of its security features are inactive at the time of install. One of the primary security features that Windows offers, unique in Microsoft environments, is its file allocation table, New Technology File System (NTFS), which allows for file-level permissions. Many administrators do not implement this format on their servers; it is inaccessible from DOS, making certain recoveries more difficult and time consuming. An administrator's first line of defense is to verify that every Windows server is formatted with NTFS and that the proper permissions have been applied.

User groups rights

After the files have been locked down, user rights need to be established for the different groups in the organization. Windows has a built-in logic on what rights each group should have. Standard groups include the following:

- ♦ Users
- ♦ Domain Administrators
- ♦ Power Users
- ♦ Backup Operators

Users should be strategically placed in specific groups depending on their job needs. However, it is recommended that users not be placed in any pre-made group. New groups with specific rights should be created for users based on their specific job needs. Administrators can keep tighter controls on their networks' user permissions infrastructure if it is created specifically for the organization. A common way of designing groups is by department. Users in specific departments tend to perform the same job duties, requiring that they all have the same rights. For example, by placing everyone in the marketing department into the marketing group, it will be easier for the administrator to keep the current employee list accurate in their system. Also, verify that only domain administrators have the right to log on locally to any machine in the server environment. This will ensure that even if a user obtains physical access to the machine, they will not be able to locally log on to the machine.

Create or edit user level accounts

Caution must be taken to avoid users having passwords that never expire. This setting will lower the security level, giving an attacker unlimited time to guess the password, and an unlimited amount of time to use the password once it is uncovered. Also, accounts where the user has established an account but never logged on should be eliminated. These accounts are frequently created with standard passwords and may give unauthorized access opportunities to an attacker. All user accounts should be checked regularly to ensure that some have not expired.

If not done during installation, create user accounts so that the administrator account does not need to be used for normal work. If an account other than Administrator was set up during the installation, check that it is not an administrator account. If needed, reset the account to Restricted User. Do not use the same password for restricted accounts as for the administrator account.

For each user, set the following:

- ♦ Users must enter a user name and password to use this computer
- ♦ Maximum password age — 360 days
- ♦ Minimum password age — 0 days
- ♦ Minimum password length — 14 characters
- ♦ Password must meet complexity requirements — Enable
- ♦ Store passwords using reversible encryption for all users in the domain — Disable
- ♦ Account lockout threshold — 3 invalid logon attempts
- ♦ Account lockout duration — 15 minutes
- ♦ Reset account lockout counter after — 15 minutes
- ♦ Audit account logon events — Success, failure

- ♦ Audit account management — Success, failure
- ♦ Audit logon events — Success, failure
- ♦ Audit object access — Success, failure
- ♦ Audit policy change — Success, failure
- ♦ Audit system events — Success, failure

Using the `net` command, the administrator can check the values of some key parameters. The following information is available by opening a command prompt and running **net account**:

```
Force user logoff how long after time expires?:      Never
Minimum password age (days):                       0
Maximum password age (days):                       42
Minimum password length:                            0
Length of password history maintained:               None
Lockout threshold:                                  Never
Lockout duration (minutes):                          30
Lockout observation window (minutes):                30
Computer role:
WORKSTATION
The command completed successfully.
```

The following information is available by opening a command prompt and running **net localgroup**:

```
Aliases for \\RISKY_SYSTEM
-----
-----
*Administrators          *Backup Operators      *Guests
*Power Users             *Replicator            *Users
The command completed successfully.
```

Use good passwords

Good passwords are key to protecting a Windows workstation. Passwords will initially be set when installing the operating system. However, passwords should be changed frequently as the Windows system is operated. Some key features of good passwords are as follows.

- ♦ The password should be at least 14 characters long, containing both letters, numbers, and special marks (such as `!"#%&/()`).
- ♦ Never use the same password in two places or systems.
- ♦ Do not use simple or obvious passwords that may be easy for an attacker to guess.



Note

A detailed discussion of password security for Windows is discussed in the section “Operating Windows Safely,” later in this chapter.

Securing the typical Windows business workstation

As discussed earlier, Windows is a general operating system. However, the typical workstation user does not need a general computing device.

The typical business Windows workstation user needs a computer to do the following:

- ♦ **Word processing and office productivity** — This is a key use of computers on the typical workstation. Word processors or text editors, presentation applications, spreadsheets, and simple database tools are the common office suite. To harden Windows for using these applications, be sure to disable macros.
- ♦ **E-mail** — Only the e-mail client is generally needed. The Windows workstation is at risk for a number of additional vulnerabilities if the user decides to run a mail server, as well. When hardening the workstation, be sure to use a virus protection application. If possible, the workstation should be set up to use Secure Shell (SSH) and port forwarding when getting and sending e-mail. In this way, the traffic will be encrypted and not subject to being sniffed on the LAN.
- ♦ **Web browsing** — Users should be instructed not to download questionable applications.
- ♦ **Occasional file transfer** — If downloading a file, only turn on the transfer capability for the short period of time it is needed. Train the user not to pull questionable files.
- ♦ **File sharing** — Use a file server to share files. Use antivirus and pest control tools on the file server. (Pest software is generally something that alters the user's workstation in a manner that is unwanted and annoying. The typical example is when irritating pop-up ads persist despite all efforts by the user to close them.)

Word processing, e-mail, Web browsing, and file transfer do not require outsiders to gain access to the Windows workstation. Therefore, the personal firewall on the Windows workstation could be set to block all outside access.

File sharing does require that outsiders have access to the workstation. This would require access through the personal firewall on the Windows workstation. To avoid having to open up access to the Windows workstation, file sharing should not be done directly to a file server.

Securing the typical Windows gaming system

The typical home gaming Windows workstation is similar to the business workstation, but games introduce an added risk. Games can be an uncontrolled means of introducing malcode onto the workstation. *Malcode* (also known as malicious logic) consists of hardware, software, or firmware that is intentionally included or inserted

in a system for a harmful purpose. Some forms of malware include logic bombs, Trojan horses, viruses, and worms. Three cases exist for a gaming workstation:

- ♦ The games are all purchased from trusted sources (such as shrink wrapped in a major computer chain). The software can be considered safe to put on a workstation that is exposed to a trusted LAN. It is safe to have this gaming workstation. When no longer used for gaming, it is recommended that this workstation be rebuilt with a new operating system. Games are notorious for interfering with an operating system. This interference is manifested in applications not working together smoothly. The security concern is that any abnormal operating system configuration is a security risk. The security controls put in place to protect a system may not be valid if the operating system has been subtly altered due to a game installation.
- ♦ The gaming software is acquired from sources that cannot be verified. Such software should be considered questionable and risky. This gaming workstation needs to be isolated. Ultimately, this workstation should be considered compromised and not trusted to interact with any trusted LANs. The workstation should be disconnected from any untrusted LAN. Because most homes have only one connection to the Internet, this usually means that the gaming workstation should not be connected to the Internet. It would be safe to connect this workstation to the Internet on a LAN of its own. Again, caution should be taken not to permit any personal or private data on this workstation. When no longer used for gaming, this workstation should not be connected to a trusted network, without the operating system being completely re-installed.
- ♦ If the gaming workstation must be connected to the Internet (due to the nature of the games), the workstation should be used *only* for gaming. No private data should be put on the workstation. The workstations operating system should be rebuilt frequently (approximately every three months or when switching to new games). Under *no* circumstances should this workstation be later connected to a trusted network, without the operating system being completely re-installed.

Installing Applications

After the operating system has been hardened, it is time to install the applications needed for the particular mission intended for this workstation. For security reasons, the applications on the Windows workstation are limited to the minimum needed to perform the user's mission. This is a simple matter of reducing the exposure or risk by removing a potential avenue of attack.



Chapter 10 carries this security principle even further and looks at a separation of services.

Antivirus protection

A virus is a computer program embedded in another program or data file. The virus is designed to copy itself into other files whenever the infected file is opened or executed. In addition to propagating itself, a virus may perform other tasks, which can be as benign as changing colors on the computer screen, or as malicious as deleting all files on a hard drive. Once a user's computer has been infected with a virus, it can be very difficult to isolate the virus and eradicate it. Often a user's eradication efforts are focused on the symptoms caused by the virus and miss the virus code itself.

Viruses and worms spread using means normally available on a workspace or home LAN. Some examples of how a virus spreads are as follows:

- ♦ **On bootable floppies as they are transported from machine to machine** — This is rarely seen today. It was much more prevalent in the past when games needed to boot machines to configure the workstation properly.
- ♦ **Through files shares** — An example of this is the W32NetSky virus that duplicates itself in numerous files on every open share.
- ♦ **Through e-mail attachments** — If a user opens or launches an attachment containing a virus, it can spread by sending out more e-mails, or by using any of the other methods in this list.
- ♦ **By downloading files from the Internet** — Files downloaded from the Internet and opened may contain macros or code that starts the spread of a virus or worm.
- ♦ **By exploiting a vulnerability in an application** — Once running, the virus or worm can connect to applications running on other Windows workstations. It is then free to exploit a vulnerability. An example of this is SLAMMER, which jumps from host to host, exploiting a SQL database vulnerability.

Virus protection controls should focus on the following:

- ♦ **The use of antivirus applications** — Protection against new viruses can be provided by antivirus applications that provide frequent upgrades for virus signatures.
- ♦ **Windows configuration** — Virus spread can be stopped by disabling workstation vulnerabilities, such as NetBIOS shares. NetBIOS is discussed in more detail in the “Operating Issues” section of this chapter. A virus can exploit the trust established between two users when a NetBIOS share is set up between workstations.
- ♦ **User training and awareness** — Most viruses (as well as worms and Trojan horses) can be stopped in their tracks by an aware user.

This multilevel defense against viruses and worms is shown in Figure 4-3. Because new viruses and worms are constantly being created, the best protection is to run antivirus software, properly configure Windows, and educate users on safe practices.

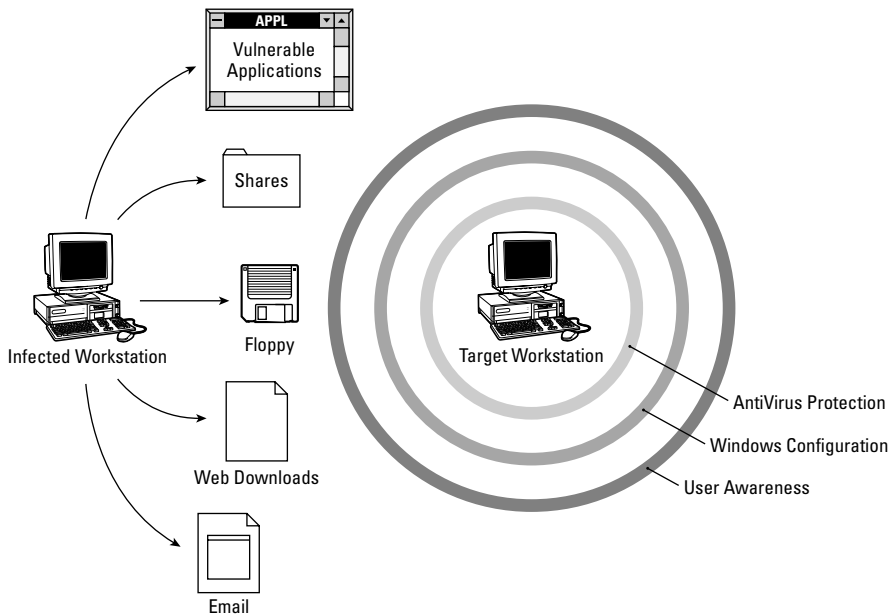

Figure 4-3: Protecting against viruses, worms, and Trojan horses

With today's threat environment, it is important to have virus protection applications running on all Windows systems. Additionally, it is important to have the current version of the antivirus software as well as the current signatures of any viruses. The virus signatures are patterns of bits inside a virus that let the antivirus software detect the virus. The antivirus software relies on periodic updated virus signature files to provide protection against the latest threats. A number of good antivirus products are available today for the Windows workstation, such as those from Symantec, Network Associates, and Computer Associates.

With virus protection software, Windows workstations can trap and block viruses before they can spread further. An organization should have protection on every server where people are saving files or storing e-mail messages. The antivirus software should be configured to provide real-time protection as well as routinely scheduled scanning. Without continuous protection, a virus can spread throughout an organization before the next routine scan is scheduled.

By providing users with training on safe Internet practices, many attacks can be stopped even before the antivirus manufacturers have released a new virus signature. Even though a virus attacks an individual workstation, it is a community problem. It is important to have organization-wide antivirus policies, procedures, and standards. If such policies are not effective, valuable data may be destroyed or disclosed without authorization. In addition, unnecessary costs are likely to go uncured, such as wasted processing resources, the cost to isolate and eradicate the virus, and the cost to restore or recreate the lost data. It is important that all

servers and workstations be checked periodically to verify that the latest virus protection software is in place, and that all file servers and e-mail servers are scanned constantly.

Personal firewalls

A personal firewall is software that runs on the user's workstation and blocks incoming and outgoing LAN traffic.

When used properly, a personal firewall can be much more effective than a perimeter firewall in protecting the user's workstation. With regard to traffic in and out of a user's workstation, the perimeter firewall configuration is usually very general. A properly configured personal firewall can be very specific to a user's need for LAN traffic.

The proper way to configure a personal firewall is to block everything in and out of the workstation. As the user encounters warnings of attempted activity that has been blocked, the user can choose to permit that traffic. In a short period of time, the user will have unblocked the majority of traffic they need to and from the LAN. The configuration of the personal firewall now represents the user's very specific needs.

Secure Shell

Secure Shell (SSH) secures connections over the network by encrypting passwords and other data. SSH is a program for logging into and executing commands on a remote machine. It is intended to replace rlogin and rsh, and provide secure encrypted communications between two untrusted hosts over an insecure network. X11 connections and arbitrary TCP/IP ports can also be forwarded over the secure channel.

As an authentication method, SSH supports RSA-based authentication. In this method encryption and decryption are done using separate keys, and it is not possible to derive the decryption key from the encryption key. Each user creates a public/private key pair for authentication purposes. The server knows the public key, and only the user knows the private key.

When launched, SSH opens a command prompt window (terminal session) to the other server or host. All traffic generated within that terminal session is encrypted. SSH was first used as a substitute for remote server management via telnet. SSH essentially opens an encrypted telnet session. But the capability to forward ports in SSH has greatly expanded its uses. The use of port forwarding to secure e-mail is described in the section "Operating Windows Safely" in this chapter.

One of the most powerful aspects of SSH is that it can be used to improve the use of less secure protocols. A common use of SSH port forwarding is for encrypting

e-mail traffic. This is useful because certain e-mail protocols, such as POP3, send the e-mail messages in the clear, meaning they are easily read and not encrypted. Without the use of SSH, the Windows client will receive e-mail from the mail server by connecting to port 110 (POP3 e-mail) on the server. The server responds by sending the client's e-mail back in the clear (unencrypted). This puts potentially sensitive traffic on at least two local segments (LANs) and the Internet. However, an SSH session can be established with a mail server using the port forwarding options to secure this traffic. For example, when establishing the SSH connection the option can be given to forward the Windows client's port 65110 to the mail server's port 110 (POP3 e-mail). Now, if e-mail is retrieved by POPping the local port of 65110, the e-mail will be retrieved from the mail server. The e-mail will be encrypted because it will have traveled over the SSH port forwarding. Mail can be sent in a similar fashion by forwarding a local Windows port to port 25, Simple Mail Transfer Protocol (SMTP), on the mail server.



The SMTP technique is discussed in more detail in Chapter 8.

Secure FTP

Secure FTP (sFTP) is a file transfer client program, which enables file transfer between the Windows workstation and an FTP server. It uses the same encryption and authentication methods as SSH. Because sFTP is an implementation of FTP over SSH, it provides all the security of SSH and all the features of FTP. In addition to transferring files, sFTP can delete files, change file names, create and delete directories, and change file access rights.

Using sFTP is the recommended alternative to NetBIOS file shares. However, with the added security comes some inconvenience. An sFTP solution to file sharing requires either a separate file server, or the need to run an sFTP server daemon on each Windows workstation. The first option, a separate file server, is recommended.

Pretty Good Privacy

Pretty Good Privacy (PGP) is a public key encryption package to protect e-mail and data files. It lets you communicate securely with anyone who has a public key. Because public keys do not require a secure channel to exchange keys, the key exchange is not difficult. Public keys can be e-mailed, put on public key servers, or put on public Web sites.

PGP integrates nicely with most e-mail clients. So, once you have someone's public key, you can send e-mail with attachments that only they can open.



Encryption and public/private keys are covered in detail in Chapter 16.

Putting the Workstation on the Network

The Windows workstation should not be put on a network without some prior considerations as to the risk that exists. Because it takes only seconds for a local attack on a new workstation, care must be taken to prepare the system before putting it on any network.

Test the hardened workstation

Prior to putting a newly hardened Windows workstation on a risky network, the system should be tested at its network interface. The test should consist of running a port and vulnerability scan against the Windows system. Any open ports should be accounted for, meaning that the application using that port should be required for the workstation's mission.

Once this initial testing is done, it should be archived for comparisons to future scans. By comparing new and old scans, the Windows workstation can be quickly checked for the addition of security vulnerabilities.

Physical security

The physical security of the Windows workstation is important because lack of physical security can quickly nullify all the work done to harden the operating system. An attacker can take over control of any Windows workstation to which they have physical access.

The Windows workstation should have a reliable supply of power. If possible, this should consist of an uninterruptible power supply (UPS). It is considered a security problem if a system is unable to perform its functions due to a loss of power. Additionally, sudden losses of power can cause loss of data and possibly hard drive failures.

Architecture

To keep your newly hardened Windows workstation secure, it is important to place it within a secure architecture. Architecture, in this case, refers to how the total network is designed and constructed. Certain portions of the network are more secure than others. The newly hardened workstation should be placed on the most secure LAN that still permits the user and the workstation to complete its mission and functions.

The security of the LAN on which the workstation is to be located should dictate the system's configuration. Figure 4-4 shows three segments with different levels of security. The least secure segment is labeled DMZ, the next most secure segment is labeled Company Intranet, and the most secure segment is labeled Personal Segment.

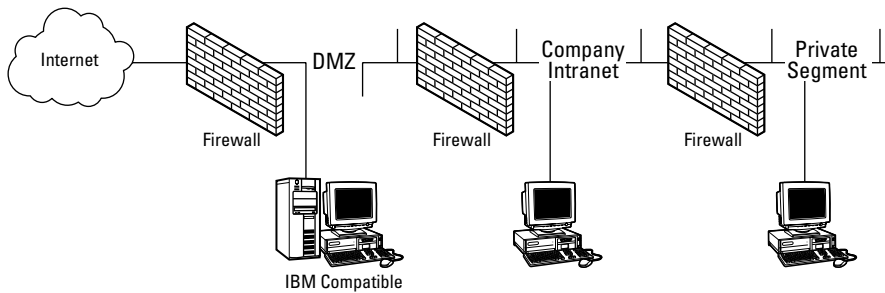

Figure 4-4: The configuration of the workstation depends, in part, on its network segment.

Any system placed in the DMZ should be locked down and very hardened. It should contain no personal or sensitive data. It should contain a bare minimum of applications. In fact, it should not have any of the normal applications that a workstation might have. It should only have the single application that requires it to be in the DMZ.

If the workstation in the DMZ does need to handle sensitive data, that data should be acquired just in time to support the transaction needing it. For example, suppose the workstation is running a Web server to provide meeting schedules for traveling salespersons. The names and meeting times of the salespersons are too sensitive to leave on a system that sits on the DMZ. If a salesperson enters the Web site and needs to know his or her meeting details, the workstation must query the information from the workstation on the intranet. This sensitive data is not stored on the DMZ workstation but rather is immediately provided to the salesperson and then deleted.

No sensitive or private data should be stored on the DMZ workstation because of the elevated risk of being compromised or attacked.

The workstation sitting on the intranet should not contain any personal or private data. Because this is a company intranet, it is safe to have company-sensitive data on the workstation. This workstation should strictly conform to company policies regarding software use. It should not be running any personal software without the knowledge of the company network administrators.

The workstation on the private network segment can have any private or personal data that is needed for the user's mission.

Firewall

The network that the Windows workstation is to be placed on should be protected from other unsecured networks (such as the Internet) by a firewall. While you may have hardened the operating system and workstation in general, it is still vulnerable to misuse of the workstation's capabilities as well as relay, spoofing, and

man-in-the-middle attacks. One of the best ways to protect against these attacks and misuse of the workstation is to keep malicious users off the local segment on which the workstation is connected, and a network firewall is a good way to do that.



Security issues related to firewalls and their configurations are discussed in detail in Chapter 13.

Intrusion detection systems

For purposes of protecting the Windows workstation, an intrusion detection system (IDS) will serve much the same purpose as the firewall, that is, to keep malicious users off the same segment or LAN as the workstation. In the case of an IDS, the attacker or attacking code is detected if it has gotten around the firewall. The IDS can also detect an attack that originates on the LAN, a case in which the network firewall would not be useful.



Security issues related to IDS and its configurations are discussed in detail in Chapter 13.

Operating Windows Safely

It is not sufficient merely to harden a Windows workstation against an attack; the workstation must also be operated safely. After hardening, the workstation must still be able to assist the user in performing some mission. If the user instead chooses to operate the workstation in a risky manner, the system may be left open to attack.

Separate risky behavior

Ultimately, the security posture of a Windows workstation depends on the activity in which the user engages. To not put at risk an otherwise secure Windows workstation, risky user behavior should be separated from other activities whenever possible, either with a separate Windows workstation, or within the multiboot capability provided in Windows NT and more recent versions of Windows.

When it comes to use of a Windows workstation, users fall into one of two personality categories (and sometimes both): risky or stable.

The stable personality uses the Windows workstation as a tool for the following types of tasks:

- ♦ **E-mail and Instant Messaging**—Limited to family, friends, and co-workers
- ♦ **Web browsing**—Shopping, entertainment, information searching

- ♦ **Multimedia**—Watching DVDs or listening to audio files
- ♦ **Document writing**—Letters, articles, diaries, presentations, recipes, and inventories
- ♦ **Photo processing**—Downloading images from digital cameras, some minor photo editing, printing photos
- ♦ **Web site maintenance**—Minor editing of HTML files for a personal or small business Web site
- ♦ **Finances**—Small payrolls, taxes, banking online, and checkbook balancing
- ♦ **Simple gaming**—Minesweeper, solitaire, time-tested, shrink-wrapped products such as flight simulator and card games

In many cases, this is the only personality that users will have. In addition to the general requirements for securing their workstation, they need to be sure to have up-to-date antivirus protection and surf the Internet safely. Not too much else will get them into trouble.

The risky personality does some or all of the following:

- ♦ **Web browsing**—With frequent downloads to try things out, such as 30-day trials and free software
- ♦ **IRC chat**—Spends significant time in chat rooms and exchanges interesting downloads
- ♦ **Multimedia**—Experiments with screen savers, movies, and short clips; Shares files on peer-to-peer forums, such as Kazaa
- ♦ **Tools**—Likes to get “toys” such as macros for Microsoft Word and Excel
- ♦ **Screensavers**—Experiments with applications such as screensavers
- ♦ **Games**—Downloads and plays risky games
- ♦ **Pirated software**—Exchanges software while intentionally hiding its origins so the receiver cannot trust the software’s pedigree

The risky games are of unknown origin and might have some of these characteristics:

- ♦ **Stresses computer resources**—Some of these games recommend changing computer chip speeds to increase performance.
- ♦ **Latest and greatest releases**—Often new versions are released before being fully tested, so the gaming community becomes the testing environment.
- ♦ **Distributed over the Internet**—While making distribution easy, it is very hard to know the origin of the software. If control of the software is lost, viruses and Trojan horses can be inserted.

Physical security issues

Physical security is a company's first line of defense against an attack. In most cases, it is much easier, given proximity access, to pick up a file folder and walk off with it, or copy it and put it back, than it is to penetrate a network undetected. The most common cause of malicious information loss is physical theft. Providing lockable secure storage space is a vital part of ensuring physical security.

Physical protection of critical application servers is a key part of network security. If someone can gain physical access to a machine they can do a lot of damage. In the simplest sense, they can unplug the machine and take down the network. All servers should be locked in racks and consistently labeled. Also, cabling to major data closets should be clearly labeled so it is evident to an administrator if patch cables have been moved and a workaround has been created.

Secure the workstation when not in use

Unless there is a specific need to have the Windows system up and running all the time, it is recommended that the system be shut down when not in use. This will reduce the exposure time of the Windows system. Because attackers are active day and night, this can significantly reduce the risk to the workstation.

If the Windows system cannot be shut down, the next best thing is to disconnect from the Internet. This can be done in a number of ways, including the following:

- ♦ Disconnect at the firewall by removing the network connection.
- ♦ Add rules to the firewall that will not allow traffic through after normal working hours.
- ♦ Disconnect the workstation from the LAN by unplugging the cable (or wireless card) or by disabling the network interface card (NIC).

When possible, sensitive data and critical components should be locked up when not in use. This is a good reason for using removable hard drives. Remember as well to lock up media and backups. Most casual backups (such as writing critical data to a CD-RW) are not password protected, so they should be locked up.

When users step away from their workstations, they should use a screen lock. This can protect the users' privacy but can also prevent the introduction of a Trojan horse by someone walking by at the right time.

Keep strangers off your systems

A Windows workstation, particularly one that is already logged into, should be considered very vulnerable, because given the opportunity, an attacker could sit down with the system. In just a few seconds, a stranger could alter settings, open a

backdoor, tunnel through the firewall, or install a Trojan horse. This would be a severe security compromise to the system.

The Windows system should be protected against the wandering eyes of strangers. By “over-the-shoulder surfing” an attacker may pick up password keystrokes and private data that can be used in social engineering attacks.

Configuration issues

A number of configuration issues should be considered when securing a Windows workstation. These range from properly using antivirus protection to limiting and managing users.

Use antivirus protection

Antivirus software has been engineered to provide rapid protection against the latest virus or worm threats. However, in addition to having antivirus software installed, it must be configured and maintained properly, as follows:

- ♦ Manually run full scans periodically
- ♦ Configure antivirus software to check all new files
- ♦ Configure antivirus software to check all executables that are run
- ♦ Regularly obtain antivirus signatures and updates

Limit user rights

It is recommended that administrators limit user permissions to the minimum needed to perform their functions. Recall that a Windows workstation is a general-purpose computer. The more that it can be made a specific-purpose computer, the more secure it will be. Limiting the scope of the user’s capability will make the workstation more specific and, therefore, more secure.

If possible, the ideal situation would be to create specific user groups that have similar needs and, therefore, should have similar rights. Users can then be put into the group that best applies to them. For example, the following groups could be made:

- ♦ **Word processing**— Applications such as Microsoft Word, Excel, and PowerPoint
- ♦ **Internet**— E-mail clients, Web browsers
- ♦ **Gamers**— Various game-playing applications

A user can then be assigned to the word processing group but not the Internet group. In this way, the security risk to the Windows workstation is reduced due to less exposure to e-mail and browser-transmitted viruses and worms.

Some other restrictions that could be placed on a user are as follows:

- ♦ Access to ports
- ♦ Access to media
- ♦ Permission to shut down the Windows workstation

When considering the rights and permissions of users, it is important not to allow users to alter their own rights and permissions. This would defeat the purpose of limiting user access.

Manage user accounts

The most secure Windows workstation is still very vulnerable to abuse or misuse by a user. The overall security of the workstation depends on the user being responsible. Normally users are conscientious and responsible and trusted enough to have access to critical applications and data. This trust is granted because a user is working with the data on a particular project and there is an expectation that, while on that project, the user will be a good steward of the data. When the user changes roles and responsibilities, his or her integrity does not change, but the trust relationship does. It is appropriate to review the user's permissions and access when the user has a change in status. The following are some circumstances under which user accounts need to be managed:

- ♦ A user's role and responsibility changes
- ♦ User moves from one project to another
- ♦ User permanently changes worksites
- ♦ User leaves or is terminated from the organization

If users change their roles and responsibilities, their permissions and access should be reviewed and adjusted accordingly. If users were promoted, they will probably need more privileges on the system. They may require access to directories and applications that they previously did not need and therefore were restricted from accessing or using.

If a user migrates from one project to another, he or she will probably use the same application. However, the administrator should limit the user's access to the old project's data while opening up access to the new project.

If the user is permanently changing work locations, he or she may have to access different data and servers. Because the user will probably have a new administrator handling their account, this would be a good time to review all of the user's permissions and accesses.

It is very important to deal with a user's account when the person is terminated from or leaves an organization. The optimal procedure would be as follows:

1. Identify all data owned by the user.
2. Back up the data in case an issue regarding the user comes up in the future. If possible, make a ghost image of the user's hard drive. The length of time needed to retain this backup will vary with the user's responsibilities and the organization's policy, but a six-month time period is reasonable.
3. Transfer ownership of the data to the user's replacement or supervisor.
4. Remove the user from any groups. The user can be placed in a terminated group or a `permit_no_access` group.
5. Logs and other monitoring that user account names should be reviewed and archived if they contain activity about the user that may be needed at a later date. The length of time these logs are retained depends on the organization, but six months seems to be a reasonable length of time.

The administrator can now delete the user account if the circumstances permit. There may be reasons why an account (user name) might not be completely purged from a Windows system. For example, some timesheet and accounting packages use the user ID as a key into their database. In situations such as this, the user account cannot be completely purged from the system. Because the account cannot be deleted, the administrator needs to ensure that the account will not be used or abused in the future by an attacker. Following the preceding steps should ensure this.

All of this management of the user's account is predicated on the appropriate administrators knowing when the status of a user has changed, such as a user being terminated, being added or removed from a project, and so on. All of these activities are enacted by someone other than the administrator. Normally, HR or a project manager determines a user's change of status. However, in many organizations, there is no formal process established for the system administrators to be informed about such a change of status. A formal system, which ensures that administrators are informed of the change in status of users, is important for the overall security of the Windows system.

Configuration control

Configuration control is very much a security issue. Attackers can be expected to take the path of least resistance. They will scan thousands of machines to find the one that most suits their purpose. System administrators must not only have secure configurations, but they must also have good configuration control. No system can be allowed to slip through the cracks. Configuration control should be used in concert with a test LAN, recommended later in this chapter. New systems should be configured and hardened prior to being put on the Internet or intranet.

Very subtle changes in a system and the infrastructure can severely impact security. The process of maintaining and administering systems should be formal and well documented. Procedures and hardening guides should be developed and used religiously.

Control users on the system

Control of user accounts is a key component for the overall security of the Windows workstation. A number of problems can arise when personnel leave an organization or change positions and their accounts are not terminated. The account holder is no longer bound by any rules or policies of the organization and they may no longer have any loyalty to the organization to safeguard and protect what was once trusted. Old accounts are often the targets of attackers. They have the advantage of being alterable without anyone raising concern.

A system for reporting the status change of an account is important so that the Windows workstations can be kept current. Whenever a person changes positions, responsibilities, or leaves the organization, all affected Windows systems should be updated to reflect the change in personnel.

The following are additional steps that can be taken to control users on a Windows system:

- ♦ Limit creation of accounts.
- ♦ Delete accounts no longer needed.
- ♦ Monitor for accounts that are no longer used.
- ♦ Periodically review a person's account and access as they change job responsibilities.
- ♦ Limit account (user) rights to the minimum needed for the user.
- ♦ Limit the use of Administrator privileges.

Use digital certificate technology

Using encryption and digital technology on a Windows workstation can provide a significant improvement in security. Encryption can improve security in two general ways:

- ♦ If a protocol that transmits data in the clear is used
- ♦ As an added defense if a security control fails or is compromised

A number of protocols commonly in use today do not provide for data encryption. Some examples are FTP for file transfer, SMTP for sending e-mail, and POP for receiving e-mail. These protocols all authenticate and transfer data in the clear (unencrypted ASCII text). Encryption can be added to the use of these protocols to

make the entire transaction unexploitable if someone is sniffing the line. For example, FTP, SMTP, and POP can all be done over an SSH session. In the case of FTP, a secure FTP client is used. In the case of SMTP and POP, the SSH session is established and the two needed ports are forwarded over the SSH connection.



This method of securing e-mail is discussed in detail in Chapter 8.

A defense-in-depth strategy calls for backup protection if the security on a Windows workstation breaks down. If the workstation were compromised and taken over by an attacker, the data on the workstation could still be protected if it were encrypted.

Know the software running on the workstation

The Windows workstation is likely to be its most secure just after installation and hardening. As time goes by, most activity on the workstation will threaten the security, however slightly. One aspect of the security of the workstation deals with the software that is running. There are several reasons that the applications running on the Windows workstation might need to be reviewed. Some examples are as follows:

- ♦ The user roles and responsibilities will change over time. In this case, the user may no longer need one or more of the applications originally installed on the Windows workstation.
- ♦ New responsibilities may have lead to the user loading additional applications onto the workstation.
- ♦ An application may no longer be needed because the project requiring it has ended.
- ♦ Users may have installed applications and games from the Internet.

There are likely to be many changes to the software running on a Windows workstation over time. To maintain the highest level of security, an administrator, should be aware of the software running on the Windows workstation. Particular attention should be paid to software that interacts with the network. This software can be detected when the network administrator does a scan of open ports on the Windows workstation. (This is further discussed in Chapter 18.)

If the user has loaded software on to the Windows workstation, the administrator should consider taking the following actions:

- ♦ **Remove the software**—If the application the user has installed is too risky to the security of the Windows system, the administrator may have to remove the software.
- ♦ **Apply patches**—If the application is needed, it will have to be maintained and kept up-to-date with patches and upgrades.

- ♦ **Use less vulnerable versions of the software**—In some cases, the user will have a legitimate need for the software but may not have chosen the most secure application. If a more secure version is available, the Windows administrator should remove the old application and install a more secure version. An example of this would be when the user has installed an FTP client for file transfer when a secure file transfer application, such as sFTP, would work just as well.

Operating issues

Users and system administrators should adhere to a number of good operating techniques. These techniques or procedures reinforce the security configuration and hardening that has already been put into the Windows workstation.

Adhere to policies

It is important that users adhere to security policies within an organization. Often these policies will be established to coordinate the various security measures across an organization. A risk in one area may be mitigated by establishing a security control on the Windows workstation. For example, there may be a subnet on the corporate LAN that routinely has untrusted users on it (perhaps for training non-employees). The company security policy may require an added rule in the personal firewalls on all Windows workstations to block access from that subnet. If the Windows workstation administrator were to remove this rule, the workstation would be at greater risk.

Minimize use of administrator account

It is often the case that normal users on a Windows workstation will also have access to the administrator account. The user will occasionally have to log in as administrator to install software or to do a number of other administrative-level tasks. If possible, the user should resist the temptation to stay in the administrator account. Best security practices would dictate that the user use the administrator account only when absolutely necessary. Any protection afforded the Windows workstation due to the limitation of privileges or the protection of files will be bypassed if the user always uses the administrator account out of convenience.

Enforce good data handling

The Windows security risk can be significantly reduced by practicing good data handling. The proper handling required for the data depends on the environment in which the Windows workstation is placed. If the workstation is on the Internet or in a DMZ, it should have no critical or sensitive data. If the workstation is on an intranet, it can have company-sensitive data, but should not have personal data. If the workstation is on a personal or private network, it can have any level of sensitive and private data.

As a general rule, for the best security, the user should minimize the storage of private or sensitive data. Special care must be taken to remove information that is stored but not obvious to the user. Data can be stored by the Web browser, in Microsoft Word documents, or in deleted files.

Web browsers store information about the sites visited. In addition to the URLs visited, data about Web transactions can be stored in cookies. Some cookie data is *persistent*, meaning that it will be stored on the hard drive.



More information about cookies and Web browsers is provided in Chapter 7.

Microsoft Word documents also contain hidden metadata, such as who has created the document, when it has been created, what has been changed, and by whom. Information that was thought to have been deleted from a Word document might still reside in the metadata of the document. Any of the following techniques should clear the metadata out of the Word documents:

- ♦ Save the document to a format that does not hold metadata, such as Rich Text Format (RTF). The RTF file can then be immediately opened as a Word document and will not contain the metadata. Unfortunately, some information may be lost, such as styles unique to the original document.
- ♦ Select and copy the entire document, open a new document, and paste. Only the selected text will be in the new document without any of the metadata.
- ♦ Save the document using Save As. The new document will not contain any clipboard data or metadata.

Users should be aware that deleting a file doesn't erase the file's content. When a file is deleted, the first character in the name is lost and the file system loses its pointer to the storage location of the file on the hard drive. A number of tools are available to recover deleted files.

Best security practices require that data and files should be properly marked. The classification is used to determine the distribution of the data, how it should be stored, and when it should be deleted. The following provides some common examples of data classification:

- ♦ **Company Sensitive** — This information should not be divulged to the public without a nondisclosure agreement (NDA). The NDA prevents someone outside the company from disclosing the information further. Normally, this is information that would be damaging for business if the company's competitors acquired it.
- ♦ **Departmental Restricted** — This information should stay within the department that has generated the data. For example, Payroll Restricted information should not be disseminated outside of the payroll department.

- ♦ **Personal or Private**— This information should not be available to anyone beyond the individual and the few people who need to process the data, such as a payroll or human resources person.
- ♦ **Eyes Only**— This information is to be seen and used by only one individual.

Care must be taken to ensure that files are stored properly on the Windows workstation. The data should be stored in an easy-to-understand hierarchy. It is not a good security practice to try and hide the data on the Windows workstation. It is more likely that the user will lose track of the data and not delete it when the time comes.

If possible, sensitive data should be encrypted or put under password protection. PGP allows for the encryption of files. If the data is zipped, a password can be applied, but this should be considered a weak security control.

Files should be stored and handled properly when removed from the workstation. Media should be properly locked up and handled commensurate with the classification of the data. The same persons or department authorized to read the data should be responsible for the off-line media. Checks should be made daily that media is properly stored and secure. In most cases, this means that storage cabinets are checked to make sure they are locked before closing down the department for the day.

Obsolete data or information should be destroyed immediately or stored in a long-term manner that allows for tight controls of its access. Long-term stored data should undergo regular destruction after a prescribed period of time. Depending on the particular business, destruction after 3 months, 6 months, or 18 months may be appropriate. When determining how long to retain media, consider the need to put out monthly reports, quarterly reports, and annual reports, such as taxes.

Avoid viruses, worms, and Trojan horses

Windows users can take steps to minimize the spread of viruses, worms, and Trojan horses on their system. The following steps require a judgment call by the user, but can provide significant protection against the spread of malware:

- ♦ Turn off any Preview feature that the mail client may have. When an e-mail is previewed, it must be opened by the mail client, first. With some e-mail clients, this will cause scripts imbedded in the message to execute.
- ♦ Don't open any e-mail from strangers that contain attachments.
- ♦ Only accept or open expected attachments. The user should have prior knowledge that the attachment was going to be sent. Many viruses today will, at first, appear to be legitimate messages. However, upon scrutiny, a user will be able to catch unexpected messages.
- ♦ Do not open attachments on e-mail that seems vague or out of character. Watch out for nondescript messages such as "Check this out." The sender should include information in the message that helps the recipient trust the

attachment. For example, instead of “Check this out,” the message should be “Bobby’s graduation pictures,” where the sender, Bobby, and a graduation are familiar or expected.

- ♦ If questionable e-mail must be received and read, use a separate e-mail client that is less susceptible to viruses. There are circumstances when a user is part of a public mailing list in which the members routinely share files. If attachments from this mailing list are routinely opened, an e-mail client that does not run Visual Basic scripts should be used.
- ♦ Turn off the use macros features in spreadsheet applications and word processors. Macros in word processing files are rare. Macros are more common in spreadsheets, but still infrequent enough that they can be enabled on a case-by-case basis.

In many cases, the preceding procedures require a judgment call on the part of the user. This judgment must be sharpened over time as the user becomes more aware of the risk of viruses.

Use good passwords

It is important to remember that the length of the password determines how long it will take someone to crack it. For example, a six-character alphanumeric password (a–z, 0–9) can be cracked in a mean time of about 10 hours. If these passwords were used on a Windows workstation, the user would be required to change the password every day.

However, a password containing 10 alphanumeric characters and symbols (such as !@#%&^*+<>?!|{})) has a mean time to crack of over 60 days. Therefore, the password policy can allow these passwords for 30 to 60 days.

As a general rule, passwords should be changed on a regular basis for Windows workstations.

Each system should have an identification mechanism built into the access path. Each user, or the user’s supervisor, should respond to system administrators or the security organization as part of a periodic re-identification of system users. Access to a system should be disabled or suspended if the user has not used the system’s capability within a 60-day period or the user does not respond to a periodic re-identification request.

The following password requirements are recommended:

- ♦ A password should be known only to the owner of an account.
- ♦ When a password is assigned to initiate or reset access to an account, the Windows system should require the password to be changed upon initial use.
- ♦ Default passwords should be changed or removed prior to the system being placed on a network.

- ♦ Default passwords should not be allowed on a system except during the installation process, initial setup of a user, or re-initialization of a user.
- ♦ The system should not allow the password to be null or bypassed at any time.
- ♦ Passwords should not be displayed on an entry screen or any attached or associated device such as a printer.
- ♦ The Windows system should provide a mechanism to allow passwords to be changed by the user. The mechanism should require re-authentication of the user's identity prior to allowing a password change.
- ♦ Passwords should remain confidential.
- ♦ Users are not to write down their passwords.
- ♦ Users are not to save passwords electronically in unencrypted form.
- ♦ Users are not to reveal their passwords to anyone else under any circumstances, except in a temporary emergency situation.
- ♦ If a situation requires a password to be revealed to a second person, the owner of the password should change the password as soon as possible after the emergency situation has passed. During the time in which the password is shared, everyone with knowledge of the password is accountable for its use.

Systems should require the construction of access passwords, as follows:

- ♦ Passwords should be a minimum of eight characters in length.
- ♦ Passwords should contain at least one alphabetic character and at least one numeric character.
- ♦ Passwords should contain at least one special or punctuation character.
- ♦ Passwords are not to be constructed using all or any part of the following:
 - Userid
 - Proper name
 - Telephone number
 - Social security number
 - Street address
 - Date of birth
 - Common company acronym or work group name.
- ♦ Passwords are not to be constructed using common or proper names or words from the English language or other locally prevalent languages.
- ♦ Passwords are not to contain four or more characters of the same type (for example, four letters or four numbers) in succession.
- ♦ Passwords are not to contain three or more of the same character (for example, AAA or 777) in succession.

- ♦ Passwords should not be used for longer than 60 days.
- ♦ Passwords should be changed at least every 30 days on a system with critical functions or data.
- ♦ Passwords should be changed at least every 30 days, if they belong to administrative or other special privileged accounts.
- ♦ Passwords should not be reused.

Limit the use of NetBIOS

NetBIOS is used for the convenient sharing of files in an interoffice or home setting. NetBIOS also supports print sharing. NetBIOS session vulnerabilities make Windows an easy target.

If possible, remove NetBIOS from the Windows system. For Windows 95/98/ME prevent Windows from loading the NetBIOS. For a WindowsME system, run Msconfig and choose Static VxDs while unchecking NetBIOS. For Windows 95/98, rename the file *VNBT.386*. For Windows2000/XP, disable NetBIOS in the network preferences.

If the use of NetBIOS cannot be avoided, strong passwords should be used to protect the Windows workstation. Limit the shared folders to the minimum needed to accomplish the task and avoid one huge share. A group of smaller shares with fewer files in each and different access lists will reduce the risk by limiting the damage should any one share be compromised.

The existence of available shares can be determined using the net command. The following information is available by opening a command prompt and running **net share**:

```

Share name      Resource
-----
C$              C:\
ADMIN$         C:\WINNT
IPC$           Remote IPC
tmp            C:\tmp
The command completed successfully.
```

Current connections to any shares can be detected using the net command. The following information is available by opening a command prompt and running **net use**:

```

New connections will be remembered.
Status      Local      Remote      Network
-----
Unavailable Z:          \\.\host\Shared Folders  VMware Shared
Folders
Folders          \\.\host          VMware Shared
The command completed successfully.
```

Avoid NULL sessions

A null session is a session established with a server in which no user authentication is performed. A null session does not require a user name and password. Because there is no authentication, the access can be done anonymously.

To establish a null session, a user simply issues the following command:

```
net use <mount point> \\<host>\<path> /user:" "
```

The net command is a powerful command line application that configures and reports on most aspects of Windows. Here is the help menu provided by the net command; the many uses of net can clearly be seen:

```
NET command /HELP
  Commands available are:
  NET ACCOUNTS           NET HELP                 NET SHARE
  NET COMPUTER          NET HELPMSG             NET START
  NET CONFIG            NET LOCALGROUP         NET
STATISTICS
  NET CONFIG SERVER     NET NAME                NET STOP
  NET CONFIG WORKSTATION NET PAUSE                NET TIME
  NET CONTINUE          NET PRINT               NET USE
  NET FILE              NET SEND                NET USER
  NET GROUP             NET SESSION             NET VIEW

  NET HELP SERVICES lists the network services you can start.
  NET HELP SYNTAX explains how to read NET HELP syntax lines.
  NET HELP command | MORE displays Help one screen at a
time.
```

In the net use command, the <mount point> is the drive letter that will be used to access the null share. The <host> value is the system name. The <path> value is the directory or folder to be accessed. The /user:" " is a keyword. Notice that the double quoted user name is left blank. If a user name were supplied, the user would be prompted for a password.

Null sessions allow easy inter-host communications, usually at the service level. The use of null sessions can expose information to an attacker that could compromise security on a system. For example, null sessions can list the user names that allow an attacker to greatly reduce the amount of time it would take to carry out a brute force attack on a user's account.

The null session can also provide an attacker with the enumeration of machines and resources in a domain. This can make it easier for someone to break in. If an attacker can anonymously obtain the names of all of the machines in a domain and then list the resource shares on those machines, it becomes a simple matter to try all of them until one is found that is open to everyone. Now the attacker has a foothold from which to launch an attack. One possibility is that a Trojan horse is put on the hard drive for an unsuspecting user to launch.

Null sessions can provide a convenient entry point into the Windows workstation and lead to a security compromise.

Null sessions should be eliminated entirely on the Windows workstation. If business practices make the elimination of null sessions impossible, take precautions to ensure that the only information exposed is the information you want exposed.

Null sessions can also be used to establish connections to shares, including such system shares as `\\servername\IPC$`. IPC stands for inter-process communication. The `IPC$` is a special hidden share that allows communication between two processes on the same system. The `IPC$` share is an interface to the server process on the machine. It is also associated with a pipe so it can be accessed remotely.

Null sessions were originally created to facilitate the communications between hosts and servers and between domains. All of these arcane reasons have modern workarounds that do not require a Windows workstation to leave open access via a null session.

Conduct frequent backups

One of the security tasks that every user can practice is to conduct frequent backups of critical data. Of the security triad (confidentiality, integrity, availability), availability is often underrated as an important security tenet. A hardware failure can occur at any moment causing the loss of data back to the last good backup. If you can't afford to lose the last hour's work, back it up.

Backups need to occur a number of times to ensure the security (availability) of a Windows workstation. Consider backing up at the following times:

- ♦ Immediately after installation and hardening, burn a ghost image.
- ♦ Prior to applying patches and upgrades, back up all data.
- ♦ Prior to transporting the workstation, back up all data. In the case of a laptop, this could be very frequently.
- ♦ Periodically, back up all data. The time period depends on the business impact for losing the data. In most cases, this should be weekly or sooner.
- ♦ More frequently than periodically, back up critical data. In most cases, this should be no less frequently than daily.
- ♦ When making frequent changes to critical data, back up the data.

A good backup application will archive the operating system changes, changed data files, the Security Accounts Manager (SAM), and the Registry.

No backup should be considered complete until the backup has been verified.

Upgrades and Patches

Security is an ever-changing arena. Hackers are constantly adapting and exploring new avenues of attack. The technology is constantly changing with new versions of operating systems and applications coming out ever year. The result of all this change is an increased risk to the typical Windows workstation.

One favorable trend in the security community is that vendors are starting to become more security aware. Increased upgrades and patches are a result of the need to propagate fixes to security vulnerabilities. Therefore, it is important that users and system administrators keep current with the various upgrades and patches.

Keep current with Microsoft upgrades and patches

Windows security is absolutely dependent on users and administrators keeping current with Microsoft patches and upgrades. Ironically, this method of protecting applications may make systems more vulnerable to attack. Consider the problem from the attacker's perspective. Many attackers go after targets of opportunity. This means that if a vulnerable system is found, the attacker will apply the scripts to exploit the system. With the advent of patches and upgrades for a particular application, the attacker's mode of operation changes somewhat. The attacker can now search for systems that have not been patched or upgraded. Determining if a system has been patched or upgraded is generally simpler than attempting a full-blown exploit. So the ready availability of patches and upgrades for applications in your organization may in the end make you more vulnerable if you do not apply the patches and upgrades.

The market forces in today's fast-paced economy tend to lead to the development of software that is more risky from a security perspective. Software is rushed to meet deadlines without adequate and rigorous security testing. It is often left up to users to find problems and report them. This leads to an environment in which patches and upgrades are more frequent and more important to the network administrator.

Microsoft security bulletins include a rating system to indicate the severity of the problem addressed by the security updates. The Microsoft ratings are as follows:

- ♦ **Critical**—A vulnerability whose exploitation can allow the propagation of an Internet worm without user action
- ♦ **Important**—A vulnerability whose exploitation can result in compromise of the confidentiality, integrity, or availability of users' data or of the integrity or availability of processing resources
- ♦ **Moderate**—A vulnerability whose exploitation is mitigated to a significant degree by factors such as default configuration, auditing, or difficulty of exploitation

- ♦ **Low**—A vulnerability whose exploitation is extremely difficult or whose impact is minimal

It is recommended that all Windows patches, no matter their rating, be applied.



Some methods and applications that will assist in patching and upgrading the Windows workstation remotely (over the network) are discussed in Chapter 10.

Keep current with application upgrades and patches

High-visibility applications are well-known targets of hackers in search of vulnerabilities. An application should be considered high visibility if it has a large market share or large user base. There is a constant back and forth battle to keep these high-visibility applications protected against attack. As hackers discover vulnerabilities, developers quickly make patches to secure the application. This leads to a series of patches and upgrades for most high-visibility software.

It is easy to make a policy that states, “All applications will be kept current with patches and upgrades.” In practice, however, this is very resource-intensive. Accurate inventories need to be maintained. Application and system baselines also need to be known and verified. Backups should be done before every patch and upgrade. Patches and upgrades should be loaded on a test platform to verify the stability of the resulting application and system. If unanticipated, these testing and backup requirements can tax an already overworked IT department.

Patches and upgrades should be tested prior to installing them. The testing should be done by someone in the organization who has a vested interest in the work or business that will be performed on the workstation. The software vendor does not have the concern and appreciation for your organization’s business needs. There is always a possibility that a patch or upgrade will cause your business to lose time, efficiency, or data. Backups should be done prior to patching and upgrading. Whenever possible, patches and upgrades should be put onto mirror systems to assess their impact on the business operations.

Keep current with antivirus signatures

It is not enough that an antivirus application is installed on a Windows workstation. For more protection against new and emerging viruses and worms, the administrator or user must ensure that the Windows workstation is kept current with antivirus signatures. There are four key steps to getting updated signatures:

1. Download new signatures.
2. Test new antivirus downloads.
3. Deploy new signatures.
4. Continue to monitor.

Most signature updates are obtained by accessing the antivirus vendor's site and pulling down the latest update. Most antivirus packages will allow the administrator to choose to have the new signatures downloaded automatically on a regular schedule. Automating the process may insure that critical updates are not missed.

If the new antivirus signature is downloaded to be redistributed throughout a large organization, it should be tested first. In certain circumstances, it is advisable to eliminate the testing in favor of a more rapid deployment of the signature files.

In large organizations, it is prudent to have an internal deployment of the tested antivirus signatures. In such a case, it is expected that the clients will get their updates from a server that is local to them. The local server, in turn, gets its files from a master server that distributes the tested update.

Finally, it is important that the Windows systems be monitored periodically to ensure that the new antivirus signatures are being automatically downloaded and (if applicable) distributed properly. When the next big virus or worm hits is not the time to find a flaw in the system.

Use the most modern Windows version

Older Windows systems have security issues that are not easily corrected or protected against. The typical example is the poor security built into LANMAN passwords. If a user's password is captured on an older version of Windows, it will be easy for a hacker to crack the password. LANMAN shortcomings can be mitigated to some degree by using longer passwords. Also, try using Unicode in the password by holding down the Alt key while entering a four-digit number on the keypad. There is a chance that the brute force password cracker may not try Unicode examples.

The newer the Windows system, the more security that is built into the operating system. Windows 2000 and greater does not have the LANMAN vulnerability.

Certain applications may require older versions of Windows operating systems. Consider running these applications in a virtual session, such as provided by VMWARE. In this way, the newest operating system can be used as the base system on the workstation, while still allowing the ability to run the legacy applications.

Maintain and Test the Security

The threat against a Windows workstation is constantly changing and improving. More and more hackers are experimenting with attack tools. The propagation of tools for hacking is greater now than it has ever been. This means that the administrator of a Windows system must be diligent in maintaining and testing the security of the workstation.

Scan for vulnerabilities

A Windows system should be periodically checked for vulnerabilities and open ports. A number of good scanners can do this, such as nmap, nessus, and several commercial versions. Each vulnerability and open port should be justified for its business requirement.



Scanning is discussed in detail in Chapter 18.

Test questionable applications

Whenever there is a need to put a new but questionable application on a Windows workstation, it should be tested first. If the application is of unknown origin or pedigree, it should be considered questionable. Shrink-wrapped products purchased in retail stores are generally safe. However, Internet downloads or free software should be considered risky or questionable.

A Windows administrator should have access to a second computer that is considered risky from a security perspective. Any new or questionable applications can be loaded on the risky system to test the application and system for viruses and other problems.

One way for home users to test questionable applications is to take a ghost image of their Windows system before uploading the questionable software. If the software turns out to be unsafe, the Windows system can be reloaded from the ghost image.

Be sensitive to the performance of the system

By far, most security issues with a Windows system are found while investigating performance issues. Attacks and exploits often work outside of the bounds of what is normal for a protocol or procedure. In many cases, side effects of exploits can be detected in system performance. Some typical performance issues that can alert a system administrator to a problem are as follows:

- ♦ Excessive hard disk activity
- ♦ Excessive or unexplained network activity
- ♦ Frequent system crashes
- ♦ Unusual application behavior

Attackers are aware that any change in the performance of the Windows system can attract a system administrator's attention. Therefore, attackers take steps to keep their activities and attacks below an administrator's radar. This means that administrators need to be even more sensitive to changes in a system's performance.

Because most Windows administrators and users do not spend a lot of time reviewing system, security, and application logs, most attacks on a system are not detected until there is a performance impact.

Replace old Windows systems

As expected, Windows is constantly improving its security. Each new Windows version has improved security features. The single biggest security problem to be corrected is the weak password protection provided by the LANMAN technology.

The threat environment today is much more severe than when Windows 95 and Windows 98 first came out. Out-of-the-box installations of these systems can be completely taken over in seconds by readily available attacker scripts. Some of the security problems with these systems cannot be corrected, including their weak password protection.

Windows NT is a much improved system from a security perspective. A lot of information is available on how to secure Windows NT. While Windows NT can be made secure, it is a long and tedious process. Additionally, the system will require a significant amount of monitoring and maintenance to keep the security posture strong.

It is recommended that you replace old Windows systems with newer, more secure systems. Note that a new Windows version should be out for 6 months to a year before it can be considered vetted. After that time, the new Windows version should have its security concerns identified.

Periodically re-evaluate and rebuild

A Windows workstation will be at its peak performance and highest security level just after being built and hardened. The security of the system will degrade over time. The system will undergo many changes over time; some will be obvious, such as adding applications, and others will be subtle and hidden in the Registry.

It is recommended that a user or administrator re-evaluate the security posture of the Windows system periodically. If done religiously at specific times, it can become part of the information technology (IT) culture. Some good times to re-evaluate the security of a Windows system are as follows:

- ♦ When a user is added or deleted from a system
- ♦ When major updates or patches are added
- ♦ When the clocks are changed for Daylight Savings Time and smoke detector batteries are replaced
- ♦ During the usually quiet weeks over the 4th of July and the last week of December

It is also recommended that you back up and rebuild your operating system periodically. The frequency depends on a number of factors, including the following:

- ♦ The amount of experimenting that you do on a system
- ♦ The amount of different game playing done
- ♦ Whether the system is used for software development
- ♦ If the system is operating strangely or crashing more frequently

With low or moderate use, such as a home system, Windows should probably be rebuilt once a year. With a system that experiences heavy use, such as software development and experimentation, the system should be rebuilt as frequently as every three months.

Monitoring

Hardening Windows and protecting the network tend to address known security issues. However, a Windows system administrator needs to have a constant vigilance to be able to catch emerging security threats. Monitoring can detect attacks on the system as well as poor operations by the users.

Systems should be checked commensurate with the risk of lost data and lost productivity. If any loss of data or productivity cannot be tolerated, monitoring must be continuously done. If good backup and recovery mechanisms are in place, monitoring can be done less frequently, such as on a weekly basis.

The administrator can monitor for risky behavior. The following should be monitored:

- ♦ System logs
- ♦ Mail logs
- ♦ Failed access attempts
- ♦ Application errors
- ♦ Changing of critical files
- ♦ Permissions on critical files
- ♦ Performance tests
- ♦ Disk usage

The Windows system should also be checked for the installation of questionable applications and the careless use of data management.

Logging and auditing

The Windows administrator should turn on as much logging as can be supported without adversely affecting the system performance and logging resources. Be mindful that too much logging may reduce the effectiveness of monitoring the system.

Be sure to log system restarts. Being able to match up the start of a system with other observed problems is very useful when tracking down security problems.

The logs should be reviewed and audited periodically. The frequency depends on the environment in which the workstation is located. If the workstation is directly connected to the Internet, such as in a DMZ, the system, security, and application logs and events should be audited daily or more frequently. If the workstation is behind a firewall and on a company LAN, the auditing should be done weekly. If the workstation is well protected with firewalls and is on a private and very secure network, the auditing can be done monthly.

Clean up the system

It is a good practice to periodically clean up the Windows system. The workstation can collect various items that are best purged. The following is a sample of items that, if removed, could lower the risk of a security problem on a Windows workstation:

- ♦ Go through Add/Remove Programs and remove any programs that were installed but are no longer used.
- ♦ Archive and remove old work projects that are no longer active. In the event that the workstation is compromised or lost (due to some physical disaster), the risk of losing this data will be minimized.
- ♦ Check to make sure that any company-sensitive data that was not removed in the previous step is properly marked. The organization needs to set policies regarding marking data, but in essence, the data should not be viewable without the person clearly knowing the sensitivity level of the data. For printouts, this means labels on the top, bottom, front, and back. In the case of e-mail, it is usually a statement at the bottom of the e-mail. And in the case of data on a screen, the sensitivity must also be viewable on the screen.
- ♦ Run built-in Windows tools for cleaning up a disk drive. This will delete temporary files that are no longer needed. This will also delete cached Internet information. It is important to remove cached Internet information because an attacker may use it to conduct social engineering against the workstation's user.
- ♦ Review and remove any private data that has been put on the workstation inadvertently.

Prepare for the eventual attack

Despite your best efforts to harden your Windows system and protect the network, security incidents will happen. There are some things that the Windows system administrator can do to prepare for the eventual attack.



Chapter 17 covers security incident response in depth.

Preparation for an attack starts with the knowledge of what to do. Chapter 17 is an excellent place to start. Administrators of large networks may need more formal training such as that available with SANS (www.sans.org).

Learning what to do in the event of an attack will lead to the development of a plan. This plan may be formal and written or just in the administrator's head. Items in the plan should have a lead-time, such as the following:

- ♦ Buy that inexpensive backup system now, when you can shop for the bargains. After the attack occurs, there will be a rush to get a backup system and it is likely to be more expensive.
- ♦ Install backup hard drives into existing systems.
- ♦ Have a backup Internet service provider (ISP); a phone connection will work nicely.
- ♦ Test your backup ISP connection monthly.

As long as Windows remains a popular operating system, it will be a major target for attack. The best that a system administrator can do is prepare the Windows workstation, place it on a safe network, operate safely, keep current with patches and upgrades, and be diligent in monitoring and testing.

Attacks Against the Windows Workstation

There are many vulnerabilities for the Windows operating system. A visit to Web sites such as NTBugTraq and SecurityFocus will show that the list of vulnerabilities is growing every day.

Viruses

A virus is a piece of code that inserts itself into other legitimate software. As with a biological virus, the computer virus is not viable if found on its own. The virus needs the host software or file to propagate and carry out its mission. A virus is able to replicate itself and propagate with the host software or file.

Early viruses infected boot sectors of floppies and were spread by the sharing of applications on floppies. Today, floppies are too small to be practical for the sharing of applications, so boot sector viruses are not common anymore.

Certain viruses are able to attach to data files such as spreadsheets and word processor files. These viruses are able to take advantage of the scripts that can be put into such files. These scripts are Visual Basic code that can execute when the file is loaded.

One of the first widespread viruses was Melissa, which spread by infecting Microsoft Word files. When the Word files were opened, the virus code would run and infect the *Normal.DOT* template file used by the word processor. Now any Word document saved would have the Melissa virus. Melissa used the autorun macros in a Word document to run a Visual Basic script when an infected Word document was first opened. Microsoft now has a feature called Macro Virus Protection that can stop macros from running. This protection should not be disabled.

If the virus has attached itself to an application, the code in the virus is run every time the application runs. The virus code will have the same privileges as the host application. A typical example of a host for this kind of virus is a self-extracting video clip. When the unsuspecting user launches the file to extract the video, the virus code runs. This virus spreads by persons sending the self-extracting video clip to their friends.

E-mail viruses move from PC to PC as part of the body of a message. When the virus code is executed, a message with the virus embedded is sent to other mail clients. The virus can either be an attachment that must be opened or an embedded script. Scripts can have access to the user's address book, and can use those addresses to propagate the virus-infected message.

The ILOVEYOU virus in the spring of 2000 was simply an attachment that users launched. Once launched, the virus's Visual Basic script sent out an infected message to everyone in the user's address book.

Disabling the Windows ability to run Visual Basic will stop the scripting attacks such as the ILOVEYOU virus. It is rare that a user needs to run a Visual Basic scripting program. The running of Visual Basic scripts can be disabled by deleting the association of VBS and VBE files with the Windows Scripting Host. The association is changed in the Windows Explorer tools options. In Windows 98, the Windows Scripting Host can be removed with the Add/Remove Programs feature.

Worms

A worm is code able to replicate itself while propagating to other hosts. In addition to replicating and propagating, worms can have code that might be destructive.

The difficult task for a worm is its need to get code to run on a remote host. To do this, the worm must exploit a vulnerability on the remote host.

The best protection against worms is to stay current with patches and upgrades for Windows as well as for the major applications. Most worms exploit previously identified vulnerabilities that are correctable with patches or upgrades.

The other protection against worms is to minimize the services and applications running on the workstation. For example, worms often target common, high-visibility applications, such as the Microsoft Web server, Internet Information Server (IIS). If a workstation does not need to serve up Web pages, this product should be removed from the workstation. If a worm does attack the Internet searching for IIS servers, it will not affect those workstations from which the Web server has been removed.

Worms differ from viruses in that they are much more complex routines tailored to the target company, designed to embed themselves in binary executable files, and able to alter or destroy data. Lack of a version control system places a company's data in jeopardy. Software systems that detect these types of attacks allow a quick response to the corruption of data. Important and critical systems files need to be identified and strictly controlled.

Trojan horses

A Trojan horse is a program that masquerades as a legitimate application, while also performing a covert function. The user believes they are launching a legitimate application, such as a screen saver. When the Trojan horse runs, the user has every indication that the expected application is running. However, the Trojan horse also runs additional code that performs some covert activity. The possibilities for covert activity are almost limitless.

The best way to detect a Trojan horse is to identify executable files that have been altered. This is most easily done by baselining cyclic redundancy check (CRC) values for all executable files on a workstation. If an executable file is later altered to include a Trojan horse, it can be detected by comparing the current CRC value with the baselined value.

Trojan horses have a distribution problem. They do not propagate on their own. They rely on users accepting questionable executables from untrusted sources. This becomes much more of a social engineering problem. Like social engineering, it is not difficult to target a particular user and to eventually get them to execute an untested piece of code.

Trojan horses are very powerful threats to the security of a workstation, network, and organization. They bypass most security controls put in place to stop attacks. Trojan horses are not stopped by firewalls, intrusion detection systems (IDS), or access control lists (ACLs).

The key feature of a Trojan horse is that it has all the capabilities and permissions of a user—a malicious user. Most organizations put a certain amount of trust in users to not abuse the resources they have access to. All of this trust works against

the organization in the case of a Trojan horse. This can make them very difficult to defend against. As more and more improvements are made to secure networks, attackers may move to Trojan horses as a means of circumventing the security controls.

Spyware and ad support

Spyware is a group of software applications that gathers information about the workstation and users. This information is then sent back to the developer or distributor of the spyware to prepare ads or revise marketing campaigns.

Targeted marketing has long been a tenant of a good sales program. The classic example is when marketers use census data to direct more effective mass-mailing campaigns. Census data is used to find certain zip codes that have the ideal average income and number of children for the particular product being advertised. The use of census data, provided for this purpose by the Census Bureau, is inherently safe because specific names and addresses have been removed and the data is a summary of statistics for the zip code.

Spyware software, however, poses a much greater risk, because the data has a lot of specifics on a named individual. The information can be used in any number of ways, unbeknownst to the user. For example, you may be a target for intense mailing or phone marketing efforts. In the case of spyware, the user also does not know who might get hold of the data. For example, certain private data can make identity theft easier.

The Windows workstation stores personal information in a number of places accessible to applications running on the machine. The most common example is accessing the information put into Web browsing cookies.

Cookies can potentially contain a wide range of personal and sensitive data. Essentially, anything that you have entered in a Web page could have been stored into a cookie by the Web server. The Web server also decides whether the cookie is persistent or not. Consider some of the information that you may have put into a Web page in the past:

- ♦ Your name and address
- ♦ Phone numbers, e-mail addresses, instant messaging (IM) handles
- ♦ Social security numbers, bank account numbers, banking PINs
- ♦ Children's names, mother's maiden name, favorite pet name
- ♦ Employer and salary
- ♦ Car tags and vehicle make and model

It is possible to disable cookies on most Web browsers. However, this turns out not to be a practical solution in many cases. Many sites depend on cookies to implement

legitimate stateful processes by the Web server. Many people start out by selecting the option to “Ask Me Before Accepting Cookies.” However, the constant pop-ups requesting permission to accept the cookies tend to be such an aggravation that they give in and accept all cookies.

Spyware and “Big Brother”

The term spyware also refers to the set of applications that intentionally snoop and monitor user activities in a covert manner. This is reminiscent of the Big Brother in George Orwell’s *1984*. These PC surveillance tools report detailed information back to the person installing the spyware. Typical information that can be reported includes the following:

- ♦ **User keystrokes**— This can be used to capture passwords and other very sensitive data.
- ♦ **Copies of e-mails**— E-mails sent or received can be forwarded, unbeknownst to the user, to the person wanting to monitor the user.
- ♦ **Copies of instant messages**— Essentially, any communications to and from the PC can be copied and sent to the spyware’s owner.
- ♦ **Screen snapshots**— Even encrypted communications will at some point be displayed in the clear to the screen. At this point, the spyware can take a screen shot and send the image to whoever has developed or distributed the spyware.
- ♦ **Other usage information**— Login times, applications used, and Web sites visited are examples of other data that can be captured and reported back.

Spyware that reports to its owner relies on stealth to accomplish its mission. If the user knows that the spyware is present, they will remove the spyware, change their behavior, or otherwise avoid the use of the particular applications being monitored.

A number of commercial products claim to detect spyware. These products maintain a database of known spyware applications. While these products may be useful for finding the most common and blatant examples of spyware, it should not be assumed that they will find all spyware.

Physical attacks

There are numerous physical attacks to which Windows workstations are vulnerable. Most security professionals assume that if an attacker has unlimited physical access to a system, the system can be successfully attacked. Some examples of physical attacks are as follows:

- ♦ If the attacker can boot a system with a floppy disk or CD, they can get the SAM and other key information to crack passwords, or they can just delete the passwords and set up their own.

- ♦ If the attacker can boot a system with a floppy disk or CD, they can have the workstation boot into a Windows system that is configured to give them access.
- ♦ Keystroke capture devices can be placed on the workstation to steal critical data that is typed into the system, such as passwords and e-mails.
- ♦ Network traffic to and from the workstation can easily be captured or sniffed if an attacker can insert a hub or modify a switch.

Physical security addresses the threats, vulnerabilities, and countermeasures that can be used to physically attack a Windows workstation. Most organizations put too little reliance on their physical security when considering the various tools to protect a Windows system. Physical security for a Windows system should work from the premise that any system can be compromised if the attacker gains physical access.

TEMPEST attacks

Transient electromagnetic pulse emanation standard (TEMPEST) attacks consist of capturing the electromagnetic radiation leaking from electronic equipment. TEMPEST attacks are usually done by analyzing the electromagnetic radiation from the monitor. Because TEMPEST attacks can be carried out at a distance of tens of yards, this can be a concern when dealing with very sensitive data.

The best protection against TEMPEST attacks is to do the following:

- ♦ Don't operate with systems opened or in a manner inconsistent with FCC guidelines. The FCC regulates the emissions from PCs to keep down the broadcast interference.
- ♦ Limit the processing of very sensitive data to TEMPEST-certified systems.
- ♦ Be aware of the surrounding environment.
- ♦ If a problem is suspected, have the environment checked for TEMPEST emissions.

Backdoors

A backdoor is a means for an attacker to easily get into Windows workstations. Often, the initial attack on a workstation is difficult and potentially detectable by a firewall or IDS device. So the attacker will install an application that will allow him to get back into the workstation quickly and easily. These backdoors are often stealthy and difficult to detect.

If a Windows workstation has been on the Internet unprotected and unhardened for more than a day, it most likely has been "rooted" and has a backdoor installed. In such a case, the best thing to do is wipe the system clean and re-install the Windows

operating system. Although the backdoor might be detectable using host scanners, the administrator can never be sure that other changes have not been made on the workstation. Some kernel and driver modifications are difficult to detect. Some Trojan horses would be very difficult to find without a clean identical system to compare files against.

Denial-of-service attacks

Recall from Chapter 1 that security is concerned with confidentiality, integrity, and availability. It is considered a security loss if you are denied access to your data or are denied the capability to use your resources. When an attacker prevents a system from functioning normally, this is considered a denial-of-service (DoS) attack.

DoS attacks are difficult to prevent. Every computer device will have limits to its capabilities. Many DoS attacks push the device to its limits and cause it to fail. DoS attacks will often access the device in a normal manner, but so frequently that no other user can access the same device. The device does not fail, but because legitimate users cannot access the device, a DoS situation exists.

Windows workstations can best prevent DoS attacks by taking the following actions:

- ♦ Install a personal firewall.
- ♦ Use a firewall on the network.
- ♦ Limit unnecessary applications on the workstation. If the following, in particular, are not needed, they should not be loaded and run on the workstation:
 - Web server
 - Mail server
 - FTP server
 - File server

File extensions

Windows has a feature that allows the file extensions to be hidden to the user. This supposedly makes the system more convenient and user friendly. This convenience comes at a security price, however. By hiding the extensions, malicious code is able to masquerade as something benign. For example, a user might be tempted to open a file named *readme.txt*, knowing that simple ASCII text files cannot contain malicious code. However, the user will be at risk if the real file name is *readme.txt.bat*, because the true extension, *.bat*, is hidden by Windows. Now if the user opens the file by double clicking on it, the malicious code in the BAT file will run with the same permissions as the user.

File extension hiding should be disabled on the Windows systems.

Packet sniffing

A Windows workstation is vulnerable to having its network traffic intercepted and read by another workstation on the same LAN segment. At one time, this threat was restricted to when the two workstations were on the same hub. Now, tools such as ettercap are available to attackers that will allow them to read the traffic in a switched environment. In a hub environment, the traffic can be read passively without the Windows user being affected. In the switched environment, the tools set up a man-in-the-middle attack, in which the traffic is intercepted, copied, and then sent on to the intended destination.

Using packet sniffing, an attacker can read all the user's Internet traffic, including e-mail, instant messages, and Web traffic. With regard to Web traffic, the attacker sees every screen just as the user does.

The best Windows protection against packet sniffing is to use encryption whenever possible. The attacker can still intercept the traffic, but it will be encrypted and of no use.

Hijacking and session replay

Session hijacking occurs when a TCP/IP session is observed and captured by a network sniffer. The session has an originator and a target host. The attacker captures the traffic sent out by the originator. The attacker can then modify the captured traffic to allow the attacker to appear to be the target host. The traffic is now sent to the attacker instead of the original target host. All future traffic in the session is now between the originator and the attacker.

Session replay occurs when a TCP/IP session is captured by a network sniffer. Some aspect of the session is then modified (certain replays, such as transferring bank funds, may not require modifications). The modified session is then fed back onto the network and the transaction is replayed.



Hijacking and replay are discussed in detail in Chapter 7.

Social engineering

Social engineering is a method to gain valuable information about a system from personnel. Generally, the attacker uses a little bit of inside information to gain the trust of the victim. With this trust, the victim ends up providing sensitive data that the attacker can use to exploit the system further. For example, pretending to be an authority figure, an attacker may call a help desk and tell them that they forgot their password and need immediate access to a system in order not to lose a very important client. Many situations can be made up, depending on what information

has already been gained about the enterprise and the particular application. In some cases, the attacker will construct a situation that creates a lot of pressure on the personnel to get information fast.

It should be assumed that serious and malicious attackers will always want to use social engineering to make their work easier.

Information should not be provided in a public forum that does not contribute to the mission of the Windows workstation. This information might make the social engineering task easier. For example, user names and IDs should not be displayed in a manner that is visible to a stranger.

Social engineering is the hardest attack to defend against and is potentially the most damaging. Despite the best training, people will share critical and sensitive information in an effort to “get the job done.” The attacker can then do some very damaging things with this information. If the information obtained contains user IDs and passwords, the attacker can essentially do anything that a legitimate user can do.

Summary

The Windows workstation may very well be the most insecure part of an organization and a network. This is due in part to the following:

- ♦ The typical user is not well trained in security but has a great deal of influence on the security of the Windows workstation.
- ♦ The PC has been designed as a general computing platform. This leaves a lot of the design open to hacking and finding vulnerabilities.
- ♦ Microsoft has designed Windows to install in a manner that serves the widest group of customers. What is a feature to one group is a security vulnerability to another.
- ♦ Most of the work performed on an organization’s network is done on the Windows workstation. Because there is a trade-off between security and ease of doing work, it is expected that the workstation will be the most vulnerable part of a network.

The Windows workstation can be made secure. The major components to a secure workstation are as follows:

- ♦ Harden the operating system.
- ♦ Install secure applications such as antivirus protection.
- ♦ Prepare the network that will contain the workstation.

- ♦ Operate the workstation safely.
- ♦ Maintain patches and upgrades for both the operating system and key applications.
- ♦ Test and monitor the security of the workstation frequently.



UNIX and Linux Security

UNIX, Linux, and other similar operating systems are gaining in popularity and market share. UNIX is still a dominant player in the server arena, which is covered in Chapter 10. Most of the growth in UNIX popularity has been in the workstation arena.

Most of the security issues raised in Chapter 4 apply to operating a UNIX workstation safely. However, some of UNIX's unique aspects are covered in this chapter.

The Focus of UNIX/Linux Security

UNIX, Linux, FreeBSD, AIX, and so on (all referred to as UNIX in this chapter) have great potential for both being very secure and being exploited. Some of the same features that make UNIX a good target for security attacks make it powerful enough to be operated safely.

UNIX as a target

There is an ongoing debate among system administrators as to whether Windows or UNIX is the more vulnerable operating system. This debate often degrades to a mere count of vulnerabilities applicable to one side or the other. In any case, it is useful to start with an examination of why UNIX and Linux might be a target of security attacks. The following lists the four main reasons that UNIX is a target:

- ◆ Linux (and much of the other UNIX implementations) are open source.
- ◆ UNIX installations are easy to obtain, both in terms of being inexpensive (often free) and readily distributed.



In This Chapter

The focus on UNIX/Linux security

Physical security

Controlling the configuration

Operating UNIX Safely

Hardening UNIX



- ♦ Most hacking tools are available for UNIX.
- ♦ UNIX is a good environment to exchange hacks and code.

Open source

Open source means products made available along with the source code needed to rebuild or recompile the products. Open source does not mean free of cost or licenses, although it is in many cases.

Many people view open source as a major security threat. In fact, this has not turned out to be the case. While it is true that a hacker can get a head start on finding security issues by examining the code, this concern is certainly overrated, because of the extremely long hours that would be required to walk through the thousands of lines of code. However, once a flaw is identified, the source code can be very useful to the hacker in developing an exploit.

Ironically, over time, the ultimate effect of having code open to all may be that the code is better and more secure. Problems tend to be quickly fixed and thoroughly vetted. This is discussed in more detail in the section “Open Source Issues” later in this chapter.

Easy-to-obtain operating system

That Linux is low cost and freely distributed on the Internet makes it a popular operating system for experimentation. Many public forums exist in which novices can get help and support for their Linux implementation. Even solutions for complicated and obscure problems can be found with a minimal amount of searching on the Internet. If it is a popular operating system to use, it can be expected to be popular for hacking as well.

Network and development tools

Another attractive feature of UNIX and Linux for the hacker is the abundance of network tools available. Most networking tools are developed under Linux or FreeBSD first and later ported to other operating systems. Certainly the open source software and the plethora of code examples contribute to the early development of tools on UNIX.

Some examples of the free network tools that support hackers in their quest for vulnerabilities and exploits include the following:

- ♦ **tcpdump** — A low-level traffic capture application that sniffs traffic at the International Standards Organization (OSI) model’s layers 2, 3, and 4. tcpdump comes standard on most UNIX installations and supports a wide variety of layer 2 media. Because tcpdump is so universally available, its output is often used as input into traffic analysis tools.

- ♦ **Ethereal**—A network traffic sniffing application. Ethereal also provides a nice interface to work with traffic captured with other low-level tools such as tcpdump.
- ♦ **tcpreplay**—Allows for traffic captured in tcpdump to be put back on the wire. This permits the hackers to better analyze traffic and ultimately to debug their own applications.
- ♦ **nmap**—A popular port-scanning tool. It will check the status of ports on a system from the network by attempting to connect to the ports. The method of connection can be varied; likewise, nmap can run more or less aggressively through the hosts and ports.
- ♦ **Nessus**—A vulnerability scanner that calls nmap to discover open ports, then tests the ports for possible vulnerabilities. Nessus has over 500 tests and can detect most older vulnerabilities.
- ♦ **Perl, sh, and ksh**—Scripting languages that, in the hands of the hacker, become a powerful tool for automating procedures.

In addition to network tools, UNIX systems come with a fully functional development environment. All the compilers and libraries needed to completely rebuild the kernel and operating system are available as open source resources. With these development tools, the hacker can produce everything from kernel module root kits to sophisticated attack tools of their own.

Information exchange

UNIX is an attractive platform for the exchange of tools and techniques under development by hackers. Hackers are able to exchange source code and then readily recompile the applications. The hacker community has a lot of expertise in UNIX and this expertise is shared in the form of code and advice.

UNIX/Linux as a poor target

UNIX has some characteristics that make it a less attractive target for security attacks. Some of these characteristics are as follows:

- ♦ There are many versions and builds.
- ♦ Users are generally more expert.
- ♦ Scripts are not as easily run (compared with Outlook).
- ♦ File ownership limits malware spread.

Many versions and builds

While code and hacks are easily exchanged, specific exploits may not work on a majority of UNIX platforms. For example, a kernel root kit initially developed for Linux 2.4.20-8 on Red Hat may have to be tested and adapted to be useful on other

systems, such as Debian. This requires a level of discipline and configuration management that is not normally a trait of the typical troublemaking hacker. As a result, there may be many exploits developed for UNIX, but few of them are universally dangerous.

Expert users

UNIX has not made great inroads as a popular desktop workstation for the masses. It is still primarily used on servers, embedded systems, and software development platforms. All of these uses tend to make the average UNIX user more knowledgeable about the operating system and security. Therefore, if the technical expertise of the average user is greater, attacks against their platforms will, on the whole, be less frequent and harder to accomplish.

Attackers, like most forces, will seek the path of least resistance. Attacking a workstation that is managed by a non-technical person will certainly be easier than attacking one managed by an expert.

Scripts not as easily run

There are many scripting techniques in UNIX. They range from Perl to Bourne shell. However, unlike Windows, the scripting is not tightly integrated into common applications (such as Outlook and Word). In UNIX, scripts can be integrated into applications such as mail and word processing, but it is not the default configuration. This makes UNIX much less vulnerable than a Windows system that is running Outlook and allows users to commonly run powerful Visual Basic scripts.

File ownership

It is not uncommon for malware to take advantage of commonly run executables to propagate an attack. In these cases, the malware writes itself to a file that is later executed by the unaware user. This kind of attack is made possible because, to perform normal computing functions, restricted users are permitted to run executables that have root or administrator-level access to system resources. This is true for UNIX as well.

Where UNIX has an advantage is in that the file ownership is different than file execution permission. Although a user may be able to run a critical application, they usually do not own the application and therefore would not normally be able to write or alter the executable. The inability of a common user to alter an executable is a severe restriction on viruses and worms that depend on users to propagate their malware.

Open source issues

The first thing that comes to mind when considering the security issues pertaining to open source is that anyone can see the code. This means that hackers looking to

cause trouble can spend countless hours analyzing your code to find logical errors, such as the following:

- ♦ Hackers will look for embedded passwords or backdoors. The software developer may hard code a password authentication into the application as a convenience feature to the end user. This is clearly a poor practice because the passwords are easily detected and acquired. Attackers can then use the passwords to gain access to the resources outside of the constraints of the application.
- ♦ Hackers may identify places in the code where input is not properly checked. Most programmers have tunnel vision when writing code; they assume they will receive the proper input from the end user (or from another function). For code to be truly secure, programmers must assume that they will receive completely irrelevant input from the user. The programmer must really think out of the box about validating input. For example, special characters and Unicode should be considered. Simple checks on the input data may not detect data put in following a `\0` (NULL terminator). If hackers find locations where the input is not properly checked, they will attempt to exploit this by entering strange data. The result may be that the application reacts in a totally unpredicted manner, giving hackers a means to exploit the application.
- ♦ Hackers will examine the open source code for variables that are set but not properly checked. Programmers should check that their variables do not go out of range, meaning that only valid values are assigned to the variables. If a variable goes out of range, it may clobber memory or have other unintended consequences. If hackers can manipulate the application in such a way as to cause variables to go out of range, the application's behavior may be unpredictable. Under these circumstances, the application may exhibit a vulnerability that can be exploited.
- ♦ Hackers will look for instances in the open source code in which the user's input is used as code or instructions. A common example of this might be when an end user is allowed to build an SQL query. The query might then be passed to a function that executes the query. This is a dangerous practice. Merely checking the input for proper format will not suffice in this case. The end user's input should not be processed directly; rather an interpreter should be written to read the input and rebuild the SQL necessary to run the queries. This interpreter must be very restrictive in the calls it will use and make.

Having found potentially vulnerable points in the code, hackers can attempt to exploit the vulnerabilities. This is still not a simple process, but hackers are well ahead of the game just by knowing where to concentrate their efforts.

In addition to exposing the open source code to the hacker community, the code is also scrutinized by the user community. The user community does not spend time reading source code for logical (security) flaws. The user community will only identify logic errors that are encountered during an examination of the code for some

other reason, the most common reasons being that the code is faulty (does not work for that user), or the user wants to extend or improve the code to cover his or her particular circumstances.

While not as good as employing an army of “white hat” hackers (persons who test applications to find flaws to better the product, not exploit it) to scrutinize the code, software developers have hundreds of extra eyes going over their code when they make it open source. Because most people are honorable and reputable, this appears to be a net gain for software developers, from a security perspective.

When logic problems are found and brought to the attention of the user community, in open source software, they tend to be corrected quickly due to the following:

- ♦ Software developers can’t pretend that the flaws don’t exist because they are there for the whole world to see.
- ♦ The user community will often contribute to making the fix.

Open source has an added benefit of allowing security to influence the evolution of software products. For the reasons stated earlier, the development of software in an open source manner may contribute to the improvement of software available for a given need. Most user requirements have a number of applications that could satisfy the need. Except in the case of a monopoly, the user community will eventually decide which of the applications survive and become popular. When open source is subjected to this selection process, it can be assumed that the security (lack of logic errors) of the code will be a factor when the user community chooses their favorite applications. All things being equal, users will choose a secure application over a risky one.

Physical Security

The first (or last, depending on your perspective) line of defense against a security threat is physical security. Some measures can be taken to improve the security of a UNIX workstation in the event that an attacker gains physical access to the device. Physical security is discussed in detail in Chapter 2. The following UNIX-specific methods to improve the physical security of a workstation are discussed here:

- ♦ Limit access to the UNIX workstation during boot operations.
- ♦ Detect hardware changes to understand any physical changes to the system.
- ♦ Disk partitioning can lessen the impact of damage from a security problem.
- ♦ Prepare for the inevitable security attack.

Limiting access

It is a general principle that any network device (such as a UNIX workstation) can be compromised if an attacker has physical access to the device. The type of compromise varies depending on the network device. For a UNIX workstation, the following are some possible means to achieve this compromise:

- ♦ **Reboot**—If the workstation can be rebooted with a floppy or CD, an attacker can boot an operating system of their choice. In this way, they could have full access to all the workstation's resources.
- ♦ **Data collection**—If an attacker installs a covert monitoring device, such as a keystroke capturer, sensitive information may then be stored on the monitoring device. The device may either phone home the information to the attacker or the attacker may get physical access to the box a second time and retrieve the device.
- ♦ **Theft**—An attacker who can remove a hard drive from the premises will have sufficient time and resources to extract all the information on the drive.
- ♦ **BIOS control**—If an attacker is able to reboot the workstation and get into BIOS, the person may set a BIOS password to lock everyone else out of the workstation. This would constitute an effective denial-of-service (DoS) attack.

The following steps will improve the physical security of the UNIX workstation. These measures should be considered part of a defense-in-depth methodology, because all these steps together will still not completely secure a workstation that has been physically compromised:

- ♦ **Enable the BIOS password.** BIOS changes will be protected from change if this password is set. Also, if the BIOS password is in the disabled state, the attacker can enable it and set a password. This can result in a denial-of-service attack because legitimate users will not be able to boot and use the workstation.
- ♦ **Change BIOS settings.** BIOS settings should be changed to prevent booting from a floppy or CD. These are typically infrequent events, therefore the impact will, in most cases, be minimal.
- ♦ **Set the boot loader password.** Typically, this involves the Linux Loader (LILO) or Grand Unify Bootloader (GRUB) loaders. If an attacker can modify the boot loader configuration, he or she will be able to access and change resources that were otherwise off limits.

Some versions of Linux can be booted directly into a root account using one of the following commands at the boot prompt:

```
linux single
```

or

```
linux init=/bin/sh
```

In the first case, Linux boots using the single user mode. This mode, in UNIX, gives someone root access to all the resources on the host machine without needing to log in with a password. Requiring a password during the boot process will provide additional security. Single-user mode access will require a password if the following line is inserted in the */etc/inittab* file after the `initdefault` line:

```
~~:S:wait:/sbin/sulogin
```

In the second case, `linux init=/bin/sh`, Linux is booted and runs a Bourne shell instead of the `init` process. This provides the user with root access. To add a password to the LILO prompt, put the following lines in the */etc/lilo.conf* file:

```
restricted
password="<root password>"
```

The boot loader password takes effect after rebooting. When prompted, enter the root password. Now when the workstation is rebooted, any additional boot arguments will require the root password.

Detecting hardware changes

The application `kudzu` detects and configures new and/or changed hardware on a Linux system. When started, `kudzu` detects the current hardware and checks it against a database stored in */etc/sysconfig/hwconf*, if one exists. It then determines if any hardware has been added or removed from the system. If new hardware is found, the user is prompted to configure the hardware. If hardware is expected but not found, the user can remove the configuration. `Kudzu` then updates the database in */etc/sysconfig/hwconf*. If no previous database exists, `kudzu` attempts to determine what devices have already been configured by looking at */etc/modules.conf*, */etc/sysconfig/network-scripts/*, and */etc/X11/XF86Config*.

The following are just a few of the pieces of hardware identified and stored in the `hwconf` database. The full listing can be obtained with the command `kudzu -p`. Shown in the following listing are a network interface card (NIC), a floppy drive, a CD-ROM drive, and a hard drive. By storing this information and comparing it with current values, any changes in the physical hardware can be found.

```
class: NETWORK
bus: PCI
detached: 0
device: eth
driver: 3c59x
desc: "3Com Corporation|3c905C-TX/TX-M [Tornado]"
vendorId: 10b7
deviceId: 9200
subVendorId: 1028
subDeviceId: 00d5
pciType: 1

class: FLOPPY
```

```
bus: MISC
detached: 0
device: fd0
driver: unknown
desc: "3.5" 1.44MB floppy drive"

class: CDROM
bus: SCSI
detached: 0
device: scd0
driver: ignore
desc: "Matshita CDRW/DVD UJDA740"
host: 0
id: 0
channel: 0
lun: 0
generic: sg0

class: HD
bus: IDE
detached: 0
device: hda
driver: ignore
desc: "FUJITSU MHT2060AT"
physical: 116280/16/63
logical: 7296/255/63
```

Disk partitioning

Partitioning of disks on a UNIX platform can be a physical security issue. Older UNIX versions had a serious problem with the loss of a partition due to a physical error. For example, a sudden power loss may cause a mismatch between the file pointers (inodes) stored in memory and those already written to disk. Such a mismatch could cause the loss of some data on the partition. This risk is greatly mitigated with the new versions of the UNIX file systems. These file systems, such as ext3 in Linux, use *journaling* to make the recovery of damaged file systems more reliable. Journaling provides for a fast file system restart in the event of a system crash. By using database techniques, journaling can restore a file system in a matter of minutes, or even seconds, versus hours or days with non-journaled file systems. In addition to ext3, jfs, xfs, and reiserfs are also journaling file systems.

Even with journaling, data in a file system (partition) can be lost due to disk damage. One measure that can be taken to reduce this risk is to spread files (based on their use) across different partitions. One partition should contain non-changing operating system files. This is usually the */usr* directory. If this partition is lost due to some physical problem, the partition can readily be restored either from backup, or by re-installing the operation system. Because this partition will rarely change, incremental backups can be done quickly.

The directory `/usr/local` is one place under `/usr` where applications may install themselves. Even though this appears to be on the `/usr` partition, it can be mounted as a separate partition during the boot process. The most common way to do this is in the `/etc/fstab` with a line such as the following:

```
/dev/hda6      /usr/local      ext3    defaults    1 2
```

It is advisable to put the `/home` directory on a separate partition. This partition holds the home directories of the users who can log in to the workstation. In many cases, these directories will hold configuration information for the individual users.

There should also be one or more partitions that hold the data that will be used by the organization or the particular workstation (referred to here as the `/data` directory). The advantage to having the data in a separate partition is that it can be backed up and restored separately. Also, when the UNIX operating system is upgraded, the `/data` directory can be brought forward without the need to copy it off and then back onto the workstation.

Consider directories that could grow very large and, as a result, cause a denial of service for the whole workstation. Typically, these are the `/tmp` and `/var` directories. These should each be put on a separate partition. If the `/tmp` or `/var` partition fills up, performance and operations may be impacted or impaired, but recovery will be simple. If, instead, the `/` directory is filled up (because `/tmp` was on the same partition) the operating system might hang and not be able to reboot without special procedures.

Prepare for the eventual attack

You can take certain steps to prepare a UNIX workstation for the inevitable attack. From a security perspective, these steps are usually put under the category of incident response or disaster recovery.



See Chapter 17 for more detailed information on incident response and disaster recovery.

Preparing for an attack is a three-part process — backup, inventory, and detection.

- ♦ The frequency and extent of the backups (copying data and files and moving them off the workstation) should be determined by the risk of losing the files or data. The more frequently the data changes and the more critical would be the loss, the more frequent the backups should be. It is not uncommon in a rapid development environment to see several backups daily. However, other environments, such as a home user environment, might do weekly or monthly backups.

Backups should be done in a manner consistent with the sensitivity and attention given to the workstation. In most cases, daily backups are recommended.

A normal backup cycle is for incremental backups to be done every day and full backups to be done on Friday. How long the backups will be kept or, in the case of reusable media, re-used depends on the sensitivity and attention placed on the workstation. The more sensitive the data, the longer the backups should be kept. In some cases, financial data might be kept for years. If the workstation does not get a lot of monitoring and it is suspected that an attack might not be readily detected, the backups should be kept for a longer period than normal.

- ♦ Inventory involves the system administrator knowing the key files on the workstation that must be checked in the event of an attack. From an operating system perspective these include password files (*/etc/passwd*) and startup scripts (*/etc/rc.d/init/**). However, individual organizations will have other equally critical files that control the mission, such as database files.
- ♦ Detection is key to any preparation against an attack. Detection or monitoring allows for the initiation of a timely response. This can be a significant factor in limiting the damage done by the attack.

If any of these three protective measures — backup, inventory, or detection — is missing or weak, the other two may be hindered to the point of not being effective. Consider the following scenarios:

- ♦ **Backups without detection** — Without adequate detection, an attacker may be on the workstation for a period of time that spans a number of backups. If the compromise is then detected and the system administrator attempts to restore from backup, they may be restoring compromised files.
- ♦ **Inventory and weak detection** — It is important to keep an inventory or status of key files on the workstation to be better prepared to respond to an attack or incident. However, without quick detection of an attack, some of these files may be changed by users and administrators over the course of normal business. If the valid users make changes on top of an attacker's changes, it will be very difficult to determine what was done by the attacker and how to mitigate the risk.
- ♦ **Detection without inventory and backups** — If inventories of key files and backups are adequately conducted, prompt detection can lead to a response that will limit the attacker's abilities to continue the attack. However, if inadequate backups were done, the recovery from the attack can be hampered. In such cases, the entire workstation may have to be taken offline and the operating system rebuilt from scratch.

The bottom line in responding to an attack or a compromised system is if you can't be 100 percent assured that you have found and corrected everything that an attacker has done, you should take the workstation offline, rebuild the operating system, and reharden the workstation, hopefully, taking the opportunity to establish good backups, inventories, and detection capabilities.

Controlling the Configuration

Controlling the configuration of a UNIX workstation is important for network security. Even stripped down and hardened, a UNIX workstation can be a powerful tool from which to launch attacks on the network or on other hosts. The configuration concerns will be addressed in two areas:

- ♦ **Installed packages or applications**—Eliminating unneeded applications and keeping required ones properly patched is key to a defense-in-depth strategy.
- ♦ **Kernel-related issues**—Because the kernel has root-level control over resources and processes, it is a critical part of the UNIX system to keep under configuration control.

Installed packages

It is important for an administrator to know what packages are installed. The “Operating Safely” section later in this chapter discusses how to control which applications are running. Even if an application is not running or planned to run, its installation should still be limited or controlled. Attackers may seek to take over a workstation to use its resources. By stripping the available software packages down to a minimum, the workstation becomes a less valuable target to the attacker. Additionally, if the workstation is overtaken, the usefulness of it to the attacker is reduced.

Following are some typical packages that should not be installed unless they have a legitimate use:

- ♦ **Mail server**—Sendmail (or an equivalent application) is commonly installed on UNIX systems. While the mail server may not be used by the average UNIX user, it is a useful tool to an attacker who has taken over control of the workstation.
- ♦ **Automatic update servers**—If automatic update services are not being used, these services should not be installed. For example, on Red Hat systems, `rhnsd` is a daemon process that runs in the background and periodically polls the Red Hat Network to see if there are any queued actions available. If any actions are queued, they are run and the system is automatically updated.
- ♦ **File-sharing services**—On UNIX systems, `smbd` is a server daemon that provides file sharing and printing services to Windows clients. The server provides filespace and printer services to clients using the Server Message Block (SMB) or Common Internet File System (CIFS) protocol. This is compatible with the LanManager protocol, and can service LanManager clients.
- ♦ **File transfer services**—The File Transfer Protocol (FTP) service is a program that allows a user to transfer files to and from a remote network site. Attackers have been known to activate FTP capabilities to use systems for their personal file transfer.

On Linux, the command **rpm -qai** will list all installed rpm packages. This produces information on each package. Following is the information available for a typical sendmail package:

```
Name       : sendmail                               Relocations: (not relocateable)
Version    : 8.12.8                                 Vendor: Red Hat, Inc.
Release    : 4                                     Build Date: Mon 24 Feb 2003
07:16:00 PM EST
Install Date: Wed 15 Oct 2003 09:36:17 PM EDT   Build Host:
stripples.devel.redhat.com
Group      : System Environment/Daemons          Source RPM: sendmail-8.12.8-
4.src.rpm
Size       : 4389045                               License: BSD
Signature  : DSA/SHA1, Mon 24 Feb 2003 11:30:42 PM EST, Key ID
219180cddb42a60e
Packager   : Red Hat, Inc. <http://bugzilla.redhat.com/bugzilla>
Summary    : A widely used Mail Transport Agent (MTA).
Description :
The Sendmail program is a very widely used Mail Transport Agent (MTA).
MTAs send mail from one machine to another. Sendmail is not a client
program, which you use to read your email. Sendmail is a behind-the-scenes
program which actually moves your email over networks or the Internet to
where you want it to go. If you ever need to reconfigure Sendmail, you
will also need to have the sendmail.cf package installed. If you need
documentation on Sendmail, you can install the sendmail-doc package.
```

Kernel configurations

The kernel is a relatively small program that controls the most critical resources on the system, such as the hard drives, memory, and video card. The kernel allows for many applications to run simultaneously by controlling their access to critical resources. Applications access these resources through system calls.

Most of the kernel code consists of device drivers — over 90 percent of which are probably not needed by any one particular workstation. Usually, the installation of UNIX or Linux does not include a compilation of the kernel. As a result, the kernel must be prepared to support a wide variety of architectures and hardware configurations. This leads to a lot of code that is not used. As a general security principle, there is no advantage to keeping unused kernel code around. Note that most of this unused code is not compiled directly into the kernel but is available to be loaded as a module when needed. Kernel modules are discussed later in this chapter in the “Kernel Modules” section.

UNIX has two modes: supervisor mode and user mode. In user mode, library functions are used. These functions then make system calls, which execute on behalf of the libraries. Because the system calls are part of the kernel itself, they have privileged access to critical system resources. Once the task (system call) is completed, control is returned to user mode.

Kernel options

A typical kernel has many options, perhaps as many as 1300 or more in the Linux 2.4 kernel. Some of the more significant security-related options are as follows:

- ♦ **iptables**—iptables is a powerful firewall that can be used on UNIX workstations. Because iptables operates at the kernel level, it must be compiled into the kernel. iptables is discussed in greater detail in the “Networking” section of this chapter.
- ♦ **IP forwarding**—With forwarding turned on, the workstation can function as a gateway or router. Traffic sent to the workstation but destined for a different IP will be routed according to the workstation’s route table. This can be a security risk. Certain network safeguards may be circumvented because the traffic will appear to come from the workstation instead of the originator. Additionally, if the workstation is multihomed (two or more NICs on different subnets), the workstation may allow traffic onto a different network. This may circumvent security controls for that network, such as a firewall or proxy. If not disabled in the kernel, IP forwarding can also be disabled after a system has booted. In Linux, the file `/proc/sys/net/ipv4/ip_forward` should contain 0 to disable forwarding.
- ♦ **Support for multiprocessors**—If multiple processors are detected on your workstation, the installation process may configure your boot loader to load a multiprocessor version of the kernel. In most cases, this will not make a difference in the security of the workstation. However, if the workstation is doing development and testing of kernel modules and system calls, the multiprocessor kernel might introduce unwanted effects.
- ♦ **Source-routed frames**—The kernel can be configured to drop source-routed frames. A source-routed frame is a packet that contains all the information needed for the packet to traverse the network and reach its destination. This source routing is not normally needed and is most often used as a small part of a larger attack. By configuring the kernel to drop source-routed frames, an added measure of security is gained.

The typical UNIX kernel comes with many features enabled that are not required. By rebuilding the kernel and eliminating these options, you will increase the overall security of the workstation. Any unneeded code is a potential source of vulnerability. Additionally, if the workstation is compromised, these unneeded features may be useful to the attacker. Following is a short list of some options that have been turned on. You can see from this small sample that a wide variety of configuration items are possible.

```
CONFIG_SCSI_CONSTANTS=y
CONFIG_AIC7XXX_TCQ_ON_BY_DEFAULT=y
CONFIG_AIC7XXX_OLD_TCQ_ON_BY_DEFAULT=y
CONFIG_AIC79XX_ENABLE_RD_STRM=y
CONFIG_SCSI_EATA_TAGGED_QUEUE=y
```

```

CONFIG_SCSI_G_NCR5380_PORT=y
CONFIG_SCSI_NCR53C7xx_FAST=y
CONFIG_SCSI_NCR53C7xx_DISCONNECT=y
CONFIG_SCSI_PCMCIA=y
CONFIG_IEEE1394_PCILYNX_PORTS=y
CONFIG_IEEE1394_SBP2_PHYS_DMA=y
CONFIG_NETDEVICES=y
CONFIG_APPLETALK=y
CONFIG_DEV_APPLETALK=y
CONFIG_COPS_DAYNA=y
CONFIG_COPS_TANGENT=y
CONFIG_IPDDP_ENCAP=y
CONFIG_IPDDP_DECAP=y
CONFIG_NET_ETHERNET=y
CONFIG_NET_VENDOR_3COM=y

```

Kernel modules

Kernel modules are dynamic extensions to the kernel that can be added without requiring a kernel rebuild or even a reboot. Kernel modules allow for the following:

- ♦ **The dynamic extension of kernel capabilities after the detection of new hardware**— When a Personal Computer Memory Card International Association (PCMCIA) card is inserted into a UNIX laptop, the operating system can load the appropriate kernel modules. Adding a Universal Serial Bus (USB) device invokes a similar response.
- ♦ **The rapid testing and modification of kernel capabilities under development**— The system call developer does not have to go through time-consuming rebuilds and reboots just to test a new version.
- ♦ **The size of the kernel loaded at boot time can be kept smaller**— Many capabilities are designated as loadable modules, so the boot time size of the kernel is kept small and manageable.

A UNIX administrator must know how to check for root kits that have been loaded as a kernel module. The **lsmod** command will list kernel modules that have been loaded. The following is a subset of typical modules loaded in a Linux 2.4 kernel:

Module	Size	Used by	Tainted: PF
i810_audio	27720	1	(autoclean)
ac97_codec	13640	0	(autoclean) [i810_audio]
soundcore	6404	2	(autoclean) [i810_audio]
agpgart	47776	3	(autoclean)
nvidia	2126120	6	(autoclean)
parport_pc	19076	1	(autoclean)
lp	8996	0	(autoclean)
parport	37056	1	(autoclean) [parport_pc
lp]			
ipt_state	1048	3	(autoclean)

iptables_nat	21720	0	(autoclean) (unused)
ip_contrack	26976	2	(autoclean) [ipt_state
iptables_nat]			
iptables_filter	2412	1	(autoclean)
ip_tables	15096	5	[ipt_state iptable_nat
iptables_filter]			
sg	36524	0	(autoclean)
sr_mod	18136	0	(autoclean)
ide-scsi	12208	0	
scsi_mod	107160	3	[sg sr_mod ide-scsi]
ide-cd	35708	0	
cdrom	33728	0	[sr_mod ide-cd]
keybdev	2944	0	(unused)
mousedev	5492	1	
hid	22148	0	(unused)
input	5856	0	[keybdev mousedev hid]
usb-uhci	26348	0	(unused)
usbcore	78784	1	[hid usb-uhci]
ext3	70784	7	
jbd	51892	7	[ext3]

System calls

A system call is a request to the operating system kernel for access to critical resources. System calls are accomplished using special instructions that allow a switch to the supervisor mode. These calls are the services provided by the kernel to application programs. In other words, a system call is a routine that performs a system-level function on behalf of a process. All system operations are allocated, initiated, monitored, manipulated, and terminated through system calls.

System calls can assist an administrator in evaluating an application's security. By examining calls that an application makes to the kernel, an administrator can determine if a security risk is involved. By viewing the system calls made by a process, it can be determined if the hard drive is being accessed when it should not be. Also, the system calls will reveal network access in a process that has no business on the network.

On a Linux system, the `strace` command is a system call tracer tool that prints out a trace of all the system calls made by a process or application. The `ltrace` command will similarly print out all library calls made. On FreeBSD you can use `ktrace`, and on Solaris `truss`.

The following example is a session that shows the use of **strace** on a simple Hello World program. First the program source is listed:

```
# cat helloworld.c
/*
```

```

* helloworld - simple hello world program
*/

#include <stdio.h>
int main(int argc, char **argv) {
    printf("Hello World\n");
}

```

Now the program is executed normally:

```

# ./a.out
Hello World

```

Finally, the program is executed with **strace**:

```

# strace ./a.out
execve("./a.out", ["/a.out"], [/* 35 vars */]) = 0
uname({sys="Linux", node="localhost.localdomain", ...}) = 0
brk(0) = 0x8049510
old_mmap(NULL, 4096, PROT_READ|PROT_WRITE, MAP_PRIVATE|MAP_ANONYMOUS, -1,
0) = 0x40016000
open("/etc/ld.so.preload", O_RDONLY) = -1 ENOENT (No such file or
directory)
open("/etc/ld.so.cache", O_RDONLY) = 3
fstat64(3, {st_mode=S_IFREG|0644, st_size=81158, ...}) = 0
old_mmap(NULL, 81158, PROT_READ, MAP_PRIVATE, 3, 0) = 0x40017000
close(3) = 0
open("/lib/tls/libc.so.6", O_RDONLY) = 3
read(3, "\177ELF\1\1\1\0\0\0\0\0\0\0\0\0\3\0\3\0\1\0\0\0`V\1B4\0"...
, 512) = 512
fstat64(3, {st_mode=S_IFREG|0755, st_size=1531064, ...}) = 0
old_mmap(0x42000000, 1257224, PROT_READ|PROT_EXEC, MAP_PRIVATE, 3, 0) =
0x42000000
old_mmap(0x4212e000, 12288, PROT_READ|PROT_WRITE, MAP_PRIVATE|MAP_FIXED,
3, 0x12e000) = 0x4212e000
old_mmap(0x42131000, 7944, PROT_READ|PROT_WRITE,
MAP_PRIVATE|MAP_FIXED|MAP_ANONYMOUS, -1, 0) = 0x42131000
close(3) = 0
set_thread_area({entry_number:-1 -> 6, base_addr:0x400169e0,
limit:1048575, seg_32bit:1, contents:0, read_exec_only:0,
limit_in_pages:1, seg_not_present:0, useable:1}) = 0
munmap(0x40017000, 81158) = 0
fstat64(1, {st_mode=S_IFCHR|0600, st_rdev=makedev(136, 3), ...}) = 0
mmap2(NULL, 4096, PROT_READ|PROT_WRITE, MAP_PRIVATE|MAP_ANONYMOUS, -1, 0)
= 0x40017000
write(1, "Hello World\n", 12Hello World) = 12
munmap(0x40017000, 4096) = 0
exit_group(12) = ?

```

When **strace** is run on a program that accesses the network, you see certain calls that belie that access:

```
# strace ping -c 1 192.168.131.131
execve("/bin/ping", ["ping", "-c", "1", "192.168.131.131"], [/* 35 vars
*/]) = 0
    <lines deleted>
socket(PF_INET, SOCK_RAW, IPPROTO_ICMP) = 3
getuid32()                               = 0
setuid32(0)                               = 0
socket(PF_INET, SOCK_DGRAM, IPPROTO_IP) = 4
connect(4, {sa_family=AF_INET, sin_port=htons(1025),
sin_addr=inet_addr("192.168.131.131")}, 16) = 0
getsockname(4, {sa_family=AF_INET, sin_port=htons(32796),
sin_addr=inet_addr("192.168.123.10")}, [16]) = 0
close(4)                                  = 0
setsockopt(3, SOL_RAW, ICMP_FILTER,
~(ICMP_ECHOREPLY|ICMP_DEST_UNREACH|ICMP_SOURCE_QUENCH|ICMP_REDIRECT|ICMP_T
IME_EXCEEDED|ICMP_PARAMETERPROB), 4) = 0
setsockopt(3, SOL_IP, IP_RECVERR, [1], 4) = 0
setsockopt(3, SOL_SOCKET, SO_SNDBUF, [324], 4) = 0
setsockopt(3, SOL_SOCKET, SO_RCVBUF, [65536], 4) = 0
getsockopt(3, SOL_SOCKET, SO_RCVBUF, [131072], [4]) = 0
brk(0)                                    = 0x8062c80
brk(0x8063c80)                            = 0x8063c80
brk(0)                                    = 0x8063c80
brk(0x8064000)                            = 0x8064000
fstat64(1, {st_mode=S_IFCHR|0600, st_rdev=makedev(136, 6), ...}) = 0
    <lines deleted>
exit_group(0)                             = ?
```

/proc file system

The */proc* directory is a pseudo-file system used as an interface to kernel data structures rather than reading and interpreting kernel memory.

Most of */proc* is read-only, but some files allow kernel variables to be changed. The kernel variable that determines whether the system can act as a router and forward IP packets is one such example. If IP forwarding is to be turned on, a 1 should be written into the file or variable at */proc/sys/net/ipv4/ip_forward*. Without IP forwarding enabled, a value of 0 is in this file.

The */proc* directory contains many parameters and kernel values needed by system calls to maintain a stable environment. The Linux manual pages describe the available pseudo-files. A few that might be of interest to a network security administrator are as follows:

- ♦ **Process ID**— There is a numerical subdirectory for each running process. The subdirectory is named by the process ID. Each subdirectory contains pseudo-files and directories. Two pseudo-files in these subdirectories are as follows:

- **cmdline**— This holds the complete command line for the process, unless the whole process has been swapped out or the process is a zombie. In either of these two cases, there is nothing in this file (a read on this file will return 0 characters). The command line arguments appear in this file as a set of null-separated strings, with a further null byte after the last string.
- **cwd**— This is a link to the process's current working directory. To determine the current working directory of process 2250, enter the following command:

```
ls -l /proc/2250/cwd
```

This will produce the following output showing the current working directory of /root:

```
lrwxrwxrwx    1 root      root          0 Sep 29 22:28
/proc/2250/cwd -> /root/
```

- ♦ **cmdline**— This pseudo-file contains the arguments passed to the Linux kernel at boot time.
- ♦ **kcov**— This file represents the system's physical memory and is stored in the Executable Linking Format (ELF) core file format. With this pseudo-file and an unstripped kernel (`/usr/src/linux/vmlinux`) binary, the `gdb` command can be used to examine the current state of any kernel data structures. To see all the data in the kernel, it needs to be compiled with the `-g` option. The total length of the file is the size of physical memory (RAM) plus 4KB.
- ♦ **net**— This subdirectory contains various net pseudo-files, all of which give the status of some part of the networking layer. These files contain ASCII structures and are, therefore, readable with the `cat` command. However, the standard `netstat` suite provides much cleaner access to these files.
- ♦ **net/arp**— This holds an ASCII readable dump of the kernel Address Resolution Protocol (ARP) table. It will show both dynamically learned and pre-programmed ARP entries.
- ♦ **sys**— This directory contains a number of files and subdirectories corresponding to kernel variables. These variables can be read and sometimes modified using the `proc` file system and the `sysctl` system call.
- ♦ **kernel/ctrl-alt-del**— The `ctrl-alt-del` controls the handling of Ctrl-Alt-Del from the keyboard. When the value in this file is 0, Ctrl-Alt-Del is trapped and sent to the `init` program to handle a graceful restart. When the value is > 0, Linux's reaction will be an immediate reboot, without even syncing its dirty buffers.
- ♦ **domainname, hostname**— The files `domainname` and `hostname` can be used to set the NIS/YP domain name and the host name of your box in exactly the same way as the commands `domainname` and `hostname`.

Operating UNIX Safely

UNIX is a powerful operating system with many tools and capabilities. Even a system that has been properly configured and hardened is still a security risk if users and processes are not properly controlled and monitored.

Any network security attack on a workstation ultimately will come down to running code. The code can fall into one of two categories:

- ♦ **Malcode**— This consists of viruses, worms, and Trojan horses. This code is either run by the user or on the user's behalf by some scripting application, such as a Web browser.
- ♦ **Host services**— In this case, the attacker comes in from the network and remotely gets a foothold or access to the workstation by exploiting an open port and its associated service. This is discussed further in the next section, “Controlling processes.”

The protection against malcode is twofold: Use antivirus protection and don't engage in risky behavior. Although this topic is discussed in detail in Chapter 4, it is worth mentioning here. Avoiding risky behavior includes the following:

- ♦ Don't open, launch, download, or execute anything that comes from a questionable source. In other words, “Don't talk to strangers.” This needs to be periodically reinforced to every level of an organization. The weakest-link principle definitely applies here.
- ♦ Whenever possible, disable scripting capabilities on e-mail clients, word processing, and other office productivity products.

Note that the security of any workstation can be enhanced by using encryption. This is discussed briefly in the “Encryption and certificates” section of this chapter.



Encryption is covered in more detail in Chapter 14.

Controlling processes

In the early days of UNIX, installations tended to be bare boned, meaning that only the bare essentials were brought into a system during installation. As UNIX and Linux got more popular, installations were made easier and the trend now is to bring in many features. All these unneeded features or applications are potential security risks.

In terms of security, you can group processes or services into three categories, as follows:

- ♦ **Avoid if at all possible** — Certain services are either out of date or so inherently insecure that they should be avoided and alternatives found.
- ♦ **Use as needed** — A small group of services are probably worth the risk and are generally more helpful.
- ♦ **Probably not needed** — Most processes probably fall into this category. Under certain circumstances they have a use but should not be run on most UNIX workstations.

Services to avoid

For the security of the UNIX workstation and the network, it is important that system administrators be kept abreast of the processes running. Because many applications in UNIX operate in a daemon or server mode, they can be ready targets for attackers to exploit.

It is a security principle that unneeded applications or services should not be running. Here are a few services commonly found on a UNIX workstation that are not normally needed.

- ♦ **FTP (`vsftpd` or `wuftpd`)** — FTP is a widely available method of transferring files. It has some vulnerabilities if anonymous access is permitted and it sends passwords in the clear (unencrypted). For these reasons, more secure methods of file transfer, such as `scp` or `sFTP`, should be used instead.
- ♦ **Network File System (NFS)** — Designed for sharing files over a network but over not the Internet. NFS is a remote procedure call (RPC) service using `portmap`. NFS makes the spreading of malware such as Trojan horses easier for the attacker.
- ♦ **`nfslock`** — The NFS file locking service. If NFS is not being used, this service should be disabled.
- ♦ **RPC** — This protocol has some inherent security problems and should be avoided if not needed. Few applications these days use RPC. Most users could operate their workstations for years and never need to use RPC. Therefore, it is advisable to turn off RPC services unless otherwise needed. Most implementations of RPC deal with homegrown remote control of the computer or distributed processing. Both of these circumstances are rare.
- ♦ **`portmap`** — This service uses RPC to support `nfslock`.
- ♦ **`r` commands (`rsh`, `rcp`, `rlogin`)** — These protocols have weak authentication and pass information in the clear (unencrypted). There are a number of better replacements, such as `ssh` and `scp`.

- ♦ **telnet**— This very simple service allows remote access to a UNIX workstation. Information is passed in the clear, so a third party could easily capture passwords and other sensitive information. Telnet sessions can easily be hijacked and taken over or redirected.

Useful services

The following services should be used if needed. In some cases, they can be made more secure by blocking their ports from the network.

- ♦ **iptables**— This is a kernel resident packet filter that works off rules controlling packets on input, output, and when they are forwarded through the workstation's network interfaces. iptables adds another layer of security and is an important defense-in-depth addition to the UNIX workstation.
- ♦ **keytable**— This script loads a keyboard map and system font during the boot.
- ♦ **kudzu**— This is a hardware-detection program that runs during the boot. It is useful if your workstation frequently has hardware changes, such as a laptop that changes docking stations frequently. If the workstation is stable and does not change, this service can be disabled.
- ♦ **network**— This script starts the network interfaces and is required if the workstation is connecting to the network.
- ♦ **pcmcia**— This is the script that inserts pcmcia kernel modules for PCMCIA cards on laptops. Even though laptops probably constitute only a small percent of installed UNIX workstations, this service is often on by default. If not applicable to the workstation's hardware, it should be disabled.
- ♦ **Print daemons (cupsd, lpd)**— These processes allow the UNIX workstation to print to network printers. While useful for that purpose, these services should not be accessible from the network. iptables should be used to block these ports.
- ♦ **random**— This script provides for the random seed for the system.
- ♦ **rawdevices**— This service enables raw Input-Output (IO).
- ♦ **sshd**— This is the server that supports remote access to the workstation using a Secure Shell (ssh) client. If remote access into the workstation is not needed, this may be disabled.
- ♦ **syslog**— This process supports the logging of system messages, which can be sent to a central server for analysis and auditing.
- ♦ **xfs**— The X Font server shares fonts with other machines to speed up font rendering and to support TrueType-style fonts. This process may be required for XWindows to function efficiently. In these cases, the port can be blocked with iptables. Also, XWindows can be started without the feature of xfs looking out to the network. To do this, start X with `startx -- -nolisten tcp`.

♦ **xinetd (inetd)**—This service starts other services on demand. `xinetd` is responsible for starting many of the common, small networking daemons. It only runs the daemon when a connection request is made for the particular service. For example, when the machine receives a `pop3` request, `xinetd` starts up the `ipop3d` daemon to respond to the request. Any service can be made available via `xinetd`. A simple configuration file identifying the port and the service to run is put in the `/etc/xinetd/` directory. The following are typical services run via `xinetd`. None of these should be needed for a typical UNIX workstation that is not functioning as a server.

- **chargen**—A service that continuously generates characters until the connection is dropped. The characters look something like this: `#!"$%&'()*+,-./0123456789:;<=>?@ABCDEFGHIJKLMNQRST
UVWXYZ[\]^_`abcdefg.`
- **cups-lpd**—An on-demand version of the print daemons discussed earlier.
- **daytime**—A service that gets the current system time then prints it out in a format such as “Wed Nov 13 22:30:27 EST 2002.”
- **echo**—A service that echos characters back.
- **finger**—A service that displays information about users on a system. With the advent of brute force and social engineering attacks, it is no longer advisable to provide user information to non-authenticated users over the network.
- **imap**—A service that allows remote users to access their mail using an Internet Message Access Protocol (IMAP) client such as Mutt, Pine, fetchmail, or Netscape Communicator.
- **imaps**—A service that allows remote users to access their mail using an IMAP client with Secure Sockets Layer (SSL) support, such as Netscape Communicator or fetchmail.
- **ipop2**—A service that allows remote users to access their mail using a POP2 client such as fetchmail. In most cases, clients support POP3 instead of POP2, so enabling this service is rarely necessary.
- **ipop3**—A service that allows remote users to access their mail using a POP3 client such as Netscape Communicator, Mutt, or fetchmail.
- **ktalk**—A K Desktop Environment (KDE) version of the talk server (accepting talk requests for chatting with users on other systems).
- **ntalk**—A server that accepts `ntalk` connections, for chatting with users on different systems.
- **pop3s**—A service that allows remote users to access their mail using a POP3 client with SSL support such as fetchmail.
- **rexec**—A server for the `rexec` routine. The server provides remote execution facilities with authentication based on user names and passwords.

- **rlogin**—A server for the rlogin program. The server provides a remote login facility with authentication based on privileged port numbers from trusted hosts.
- **rsh**—A server for the rcmd routine and, consequently, for the rsh(1) program. The server provides remote execution facilities with authentication based on privileged port numbers from trusted hosts.
- **rsync**—A server that allows Cyclic Redundancy Check (CRC) checksumming.
- **servers**—A service that lists active server processes. This is discussed in detail in a later section.
- **sgi_fam**—A file-monitoring daemon. It can be used to get reports when files change.
- **talk**—A server that accepts talk requests for chatting with users on other systems.
- **telnet**—An on-demand daemon of the telnet service discussed earlier.
- **time**—This protocol provides a site-independent, machine-readable date and time. The time service sends back to the originating source the time in seconds since midnight on January 1, 1900.

Uncommon services

The following services are useful and applicable in certain circumstances. Often these processes only apply to servers, as opposed to workstations. The system administrator should take a hard look at all these processes and if they are not needed, disable them.

- ♦ **anacron**—This service is an enhanced cron replacement. It can run jobs that were scheduled for execution while the computer was turned off.
- ♦ **atd**—This service runs scheduled batch jobs.
- ♦ **autofs**—This service auto mounts file systems on demand.
- ♦ **arpwatch**—This service is used to construct and monitor an ARP table, which keeps track of IP address-to-MAC address pairings.
- ♦ **apmd**—This is the advanced power management daemon, primarily used on laptops and other battery-backed devices. The apmd daemon senses the hardware and suspends or shuts down the workstation or laptop.
- ♦ **crond**—This service is used to schedule jobs for later execution. Many system administrator tasks can be run with cron. If this can't be disabled, authorization to run cron jobs should be limited to a few users.
- ♦ **gpm**—This service is the text-mode cut-and-paste daemon. This service has been a source of security concerns and performance problems in the past. Unless specific text-based applications are being used that require this mouse support, gpm should be disabled.

- ♦ **httpd**—This service is the Apache web server. Web servers are a high-visibility target for attacks. It is unlikely that a user's workstation needs to be running a web server. In the vast majority of cases, this service should be disabled.



Chapter 6 addresses the security of a Web server.

- ♦ **innd**—This service is the INternet News System (INN) news server. Normally this is run on a server and not a workstation.
- ♦ **irda**—This service is the Infrared TTY manager. Infrared is rarely used on a UNIX workstation, so this should be disabled.
- ♦ **mysqld and postgresql**—This service provides SQL database services. Usually, SQL databases are run on servers and not workstations.
- ♦ **named**—This service is the BIND name server used when running a Domain Name Service (DNS). This service will allow the host to resolve domain names into IP addresses. It is unusual for this service to be running on a workstation. DNS has important security concerns and needs to be configured and maintained carefully.



DNS is covered in detail in Chapter 9.

- ♦ **nscd**—This service provides password and group lookup services for use with network authentication such as that used in Lightweight Directory Access Protocol (LDAP).
- ♦ **ntpd**—Network Time Protocol (NTP) time synchronization services. If time synchronization is important, the network administrator should set up a local server to reduce the security risk.
- ♦ **netfs**—This service mounts NFS file systems.
- ♦ **RIP**—Routers use Route IP Protocol (RIP) to pass routing information. It is unlikely that the UNIX workstation is acting as a router, so this should be disabled.
- ♦ **sendmail**—This service is a mail transport agent that allows users to send mail from the workstation. Normally, the network administrator will set up one mail server to service many users and workstations. If the workstation must run its own mail server, consider using qmail or postfix, which are more secure.
- ♦ **smb**—This service runs the `smbd` and `nmbd` SAMBA daemons, which allow the sharing of files with Microsoft Windows platforms.
- ♦ **snmpd**—Runs the supporting daemon for the Simple Network Management Protocol. Unless absolutely needed, this service should be disabled due to past and present security issues.

Detecting services

Because the system administrator should disable unneeded processes, he or she must be able to detect and manage these services. Three good applications for this are `ps`, `netstat`, and `nmap`.

The `ps` command

This process gives a snapshot of the current processes running. The `ps` command will need to be run as root to pick up all the processes on the workstation.

Following is a shortened output from `ps`:

```
# ps -aux
USER      PID  %CPU %MEM    VSZ   RSS TTY      STAT START   TIME COMMAND
root         1  0.2  0.0  1376   440 ?        S    19:44   0:04  init [3]
root         2  0.0  0.0     0     0 ?        SW   19:44   0:00  [keventd]
root         9  0.0  0.0     0     0 ?        SW   19:44   0:00  [bdf1ush]
root         5  0.0  0.0     0     0 ?        SW   19:44   0:00  [kswapd]
root        217  0.0  0.0     0     0 ?        SW   19:45   0:00  [kjournald]
root        278  0.0  0.0     0     0 ?        SW   19:45   0:00  [knodemgrd]
root        498  0.0  0.0  1440   508 ?        S    19:45   0:00  syslogd -m
0
root        502  0.0  0.0  1372   424 ?        S    19:45   0:00  klogd -x
root        558  0.0  0.0  1496   480 ?        S    19:45   0:00
/sbin/cardmgr
root        623  0.0  0.1  3508  1132 ?        S    19:45   0:00
/usr/sbin/sshd
root        790  0.0  0.0  2264   440 ?        S    19:46   0:00  login -
root
root        791  0.0  0.0  1348    56 tty2    S    19:46   0:00
/sbin/mingetty tty2
root        796  0.0  0.0  4340   352 tty1    S    19:47   0:00  -bash
root       1637  0.0  0.0  2832   888 pts/2   R    20:18   0:00  ps -aux
```

The `netstat` command

The `netstat` command prints all of the following:

- ♦ Network connections
- ♦ Routing tables
- ♦ Interface statistics
- ♦ Masquerade connections
- ♦ Multicast memberships

`netstat` can display a list of open sockets identified either by their port number or by the service assigned to that port as listed in `/etc/services`. If you don't specify any address families, the active sockets of all configured address families will be printed.

Knowing what ports are open on the workstation and accessible from the network is important to operating UNIX safely. The administrator should recognize every open port and understand the need for the application that is using that port. If the administrator does not recognize the port or service, he or she must track down the service and understand why that service needs to be running on that particular workstation.

Following is a sample listing of open ports and sockets used as reported by netstat. Note that the `-p` option provides the application that is responsible for the open port. Knowing the application is important in tracking down and closing ports.

```
# netstat -ap
Active Internet connections (servers and established)
Proto Recv-Q Send-Q Local Address   Foreign Address State      PID
/Program name
tcp        0      0 *:ssh          *:.*         LISTEN    559
/sshd
tcp        0      0 localhost.localdomain:ipp *:.*         LISTEN    584
/cupsd
udp        0      0 *:bootpc      *:.*         474
/dhclient
udp        0      0 *:631         *:.*         584
/cupsd
Active UNIX domain sockets (servers and established)
Proto RefCnt Flags       Type       State      I-Node Path
unix  2      [ ACC ] STREAM LISTENING  1209   /tmp/.font-unix/fs7100
unix  2      [ ACC ] STREAM LISTENING  1343   /tmp/.X11-unix/X0
unix  2      [ ACC ] STREAM LISTENING  1368   /tmp/ssh-
XXobUrxB/agent.808
unix  2      [ ACC ] STREAM LISTENING  1835   /tmp/.ICE-unix/dcop877-
1086703459
unix  2      [ ACC ] STREAM LISTENING  1960   /tmp/mcop-root/m_r_tmp-
037e
unix  7      [ ]       DGRAM                    956   /dev/log
unix  2      [ ACC ] STREAM LISTENING  2005   /tmp/.ICE-unix/906
```

Note that this powerful tool will also provide the current routing table. Following is router table information provided by **netstat**:

```
# netstat -r
Kernel IP routing table
Destination Gateway      Genmask      Flags   MSS Window  irtt
Iface
192.168.123.0 *            255.255.255.0 U        0 0        0
eth0
169.254.0.0 *           255.255.0.0 U        0 0        0
eth0
127.0.0.0 *           255.0.0.0 U        0 0        0
lo
default    pix         0.0.0.0 UG        0 0        0 eth0
```

The nmap command

nmap is a very good port scanner that ships with many UNIX distributions and is available for all. nmap is designed to allow system administrators to scan hosts to determine what services are running. nmap supports a large number of scanning techniques, such as the following:

- ♦ UDP
- ♦ TCP connect()
- ♦ TCP SYN (half open)
- ♦ ftp proxy (bounce attack)
- ♦ Reverse-ident
- ♦ ICMP (ping sweep)
- ♦ FIN
- ♦ ACK sweep
- ♦ Xmas Tree
- ♦ SYN sweep
- ♦ IP Protocol
- ♦ Null scan

The following shows the output of two nmap scans of a Linux host. nmap can be run over the network or against the host that it resides on, as in these scans. The `-sT` option tells nmap to run a TCP Connect scan, therefore, nmap will attempt to connect to every port to determine the service running on that port. The first scan is against the host's external interface. The second scan of the localhost interface avoids the iptables (firewall) filtering that protects the host. Notice that port 631 is being blocked by iptables. iptables is discussed in detail in the "Hardening UNIX" section of this chapter.

```
# nmap -sT 192.168.1.5
Starting nmap V. 3.00 ( www.insecure.org/nmap/ )
Interesting ports on (192.168.1.5):
(The 1600 ports scanned but not shown below are in state: closed)
Port      State      Service
22/tcp    open      ssh
Nmap run completed -- 1 IP address (1 host up) scanned in 5 seconds
```

```
# nmap -sT localhost
Starting nmap V. 3.00 ( www.insecure.org/nmap/ )
Interesting ports on localhost.localdomain (127.0.0.1):
(The 1599 ports scanned but not shown below are in state: closed)
Port      State      Service
22/tcp    open      ssh
631/tcp   open      ipp
Nmap run completed -- 1 IP address (1 host up) scanned in 1 second
```

Processes controlling processes

Beyond knowing what processes are running, the system administrator must be able to schedule the proper services to run at the proper time. UNIX provides four means of controlling processes: *inti*, *xinetd* (*inetd*), *chkconfig*, and *service*.

The *init* process

After the UNIX kernel boots, it will place the operating system into one of several runlevels. The runlevel will determine which processes and services are started (or stopped). The following describes the seven runlevels in Linux:

- ♦ **Runlevel** — This is the shutdown state. When a system is properly shut down, it is transitioned into this runlevel. During that transition, certain processes or services will be killed (stopped), as defined in the */etc/rc.d/rc0.d* directory.
- ♦ **Runlevel 1** — This is the single-user mode. The system has one session (the command prompt) and the user is always root. This state is typically used to troubleshoot the workstation or when conducting backups. Some administrators might prefer to pass through this runlevel when starting up and shutting down the workstation. The processes started and stopped in runlevel 1 are governed by the files in the */etc/rc.d/rc1.d* directory.
- ♦ **Runlevel 2** — This is multi-user mode without networking. This state is rarely used. The processes started and stopped in runlevel 2 are governed by the files in the */etc/rc.d/rc2.d* directory.
- ♦ **Runlevel 3** — This is multi-user mode with networking. This is the normal state to which the system will boot. Some systems are configured to boot directly into Xwindows (runlevel 6). The processes started and stopped in runlevel 3 are governed by the files in the */etc/rc.d/rc3.d* directory.
- ♦ **Runlevel 4** — This is unused on many versions of UNIX. The processes started and stopped in runlevel 4 are governed by the files in the */etc/rc.d/rc4.d* directory.
- ♦ **Runlevel 5** — This is typically the XWindows mode. Systems are sometimes configured to boot into this state. Otherwise, this runlevel is entered by starting XWindows (*startx*) from runlevel 2 or 3. The processes started and stopped in runlevel 5 are governed by the files in the */etc/rc.d/rc5.d* directory.
- ♦ **Runlevel 6** — This is the reboot state. When *reboot* or a similar command is issued, the system transitions into this runlevel. The processes started and stopped in runlevel 6 are governed by the files in the */etc/rc.d/rc6.d* directory. All of the files in this directory are set to either kill processes or to start processes, which will in turn kill all other processes and force the reboot.

The scripts in the */etc/rc.d/rc<runlevel>.d* directories begin with an S to start a process or with a K to shut down (kill) a process. The numbers following the letters (S or K) determine the order of execution from lowest to highest.

When UNIX boots, the kernel executes */sbin/init*, which starts all other processes. The *init* process determines which runlevel to load by reading the */etc/inittab* file.

For example, the kernel will boot into the runlevel in the `initdefault` line in the `/etc/inittab` file, such as follows:

```
id:5:initdefault:
```

In this case, the default is runlevel 5, or XWindows.

The `/etc/inittab` file describes which processes are started at bootup and during normal operation (for example, `/etc/init.d/boot`, `/etc/init.d/rc`, `gettys...`). `init` distinguishes multiple runlevels, each of which can have its own set of processes that are started. Valid runlevels are 0 through 6 plus A, B, and C for on-demand entries. An entry in the `inittab` file has the following format:

```
id:runlevels:action:process
```

An important security feature that can be controlled by `init` is the process that runs when a user simultaneously presses the three keys `Ctrl+Alt+Delete`. The system administrator may need to limit a non-root user's ability to shut down a key server. The following line in the `/etc/inittab` file will set the `Ctrl+Alt+Del` interrupt to run the `exit` process. This would log off the user but would not reboot the machine.

```
ca::ctrlaltdel:/sbin/shutdown -nh now
```

Use the command `ps -aux` to view all process on your machine.

The xinetd process

The `xinetd` process (`inetd` on some platforms) is a service that starts other services on demand. It only runs the daemon when a connection request is made for the particular service. A simple configuration file identifying the port and the service to run is put in the `/etc/xinetd/` directory. The following is a listing off one of these configuration files for the POP3 service:

```
# cat /etc/xinetd.d/ipop3
# default: off
# description: The POP3 service allows remote users to access their mail \
#              using an POP3 client such as Netscape Communicator, mutt, \
#              or fetchmail.
service pop3
{
    socket_type          = stream
    wait                = no
    user                 = root
    server               = /usr/sbin/ipop3d
    log_on_success       += HOST DURATION
    log_on_failure       += HOST
    disable              = yes
}
```

Of particular interest is the last line of the configuration, `disable = yes`. This will prevent `xinitd` from responding to a request on the POP3 port. To enable POP3, the `yes` is changed to `no`.

Note that the port for POP3 is not provided in the preceding configuration file. When the port is not designated, `xinetd` uses the port listed in the `/etc/services` file, as follows:

```
# grep pop3 /etc/services
pop3      110/tcp      pop-3      # POP version 3
pop3      110/udp      pop-3
pop3s     995/tcp      # POP-3 over SSL
pop3s     995/udp      # POP-3 over SSL
```

Because the services controlled by `xinetd` are on demand, they will not run until the associated port is hit from the network. Assuming that the POP3 service is enabled (`disable = no` in the configuration file), you will see the open port in the following (shortened) `netstat` output:

```
# netstat -ap
Active Internet connections (servers and established)
Proto Recv-Q Send-Q Local Address   Foreign Address State   PID/Program
name
tcp      0      0 *:pop3         *:.*        LISTEN 2295/xinetd
```

However, when you look at the `ps` output, you do not see `pop3` running because the port has not yet been hit from the network.

```
# ps -aux | grep pop3
root      2307  0.0  0.0  3568  624 pts/2    S      07:44   0:00 grep pop3
```

The `xinetd` process can control processes in numerous ways. There are means for special logging and controlling of the services. There are several ways to lower the risk of a denial-of-service (DoS) attack.

Note

The man pages for `xinetd.conf` provide a detailed listing of these options.

The `chkconfig` command

`chkconfig` provides a command-line tool for maintaining the `/etc/rc[0-6].d` directory hierarchy. This is a big aid to the system administrators who would otherwise have to directly manipulate the numerous symbolic links in those directories.

The tool manipulates services in the following manner:

- ♦ **Add a new service for management**—chkconfig will ensure that the symbolic links are in the proper directories.
- ♦ **Remove services from management**—The symbolic links are removed.
- ♦ **List the current startup information for services**—chkconfig gives a very readable status of what services will run in which runlevels. This is convenient for the system administrator, who would otherwise have to scrutinize symbolic links to determine what will run.
- ♦ **Change the startup information for services**—chkconfig can add symbolic links to start or stop services for particular run levels.
- ♦ **Check if a particular service is to be run at a certain runlevel**—This feature differs from the previous listings in that no output is provided. Instead, chkconfig returns TRUE or FALSE for use in a batch shell script.

Following are a few lines from the output of **chkconfig** showing which services are scheduled to be run at each of the runlevels:

```
# chkconfig --list
postgresql    0:off  1:off  2:off  3:off  4:off  5:off  6:off
squid         0:off  1:off  2:off  3:off  4:off  5:off  6:off
vmware       0:off  1:off  2:off  3:off  4:off  5:off  6:off
rclocal      0:off  1:off  2:off  3:on   4:on   5:on   6:off
network      0:off  1:off  2:on   3:on   4:on   5:on   6:off
syslog       0:off  1:off  2:on   3:on   4:on   5:on   6:off
random       0:off  1:off  2:on   3:on   4:on   5:on   6:off
pcmcia       0:off  1:off  2:on   3:on   4:on   5:on   6:off
rawdevices   0:off  1:off  2:off  3:on   4:on   5:on   6:off
```

The following shows a few of the symbolic links in the `/etc/rc.d/rc3.d/` directory (runlevel 3). It is evident that the format from chkconfig is much more convenient and informative than listing all the directories.

```
K15postgresql -> ../init.d/postgresql*
K25squid -> ../init.d/squid*
K08vmware -> ../init.d/vmware*
S05rclocal -> ../init.d/rclocal*
S10network -> ../init.d/network*
S12syslog -> ../init.d/syslog*
S20random -> ../init.d/random*
S24pcmcia -> ../init.d/pcmcia*
S56rawdevices -> ../init.d/rawdevices*
```

The service command

The **service** command can affect the running of a process or report on the process's status. The service function essentially runs the process through the `init.d` scripts found in the `/etc/init.d/` directory. According to convention, these scripts take the following options:

- ♦ **start**—Force a start of the process, regardless of the current runlevel.
- ♦ **stop**—Force a stop of the process and clean up as appropriate.
- ♦ **restart**—Stop and then start the process.
- ♦ **condrestart**—Process-dependent, but usually the same as restart.
- ♦ **status**—Process dependently print some information about the process. For example, in the case of `iptables`, the current rules are listed.

With the `--status-all` option, the tool lists the status of every service that is in the `/etc/rc.d/init.d/` directory. In addition to whether the service is running, other pertinent information is displayed. Following is a shortened display of currently running processes:

```
# service --status-all
anacron is stopped
apmd is stopped
atd is stopped
Configured Mount Points:
-----
Active Mount Points:
-----
crond is stopped
gpm is stopped
httpd is stopped
sshd (pid 638) is running...
syslogd (pid 528) is running...
klogd (pid 532) is running...
tux is stopped
winbindd is stopped
xfs (pid 817) is running...
xinetd is stopped
```

Controlling users

In addition to controlling processes, it is necessary to have controls over the users of the UNIX workstation. This consists of controlling the user's access to files and their ability to run processes. The UNIX file permission scheme determines what

access a user will have to any given file. Controlling a user's access to processes mostly concerns controlling root access.

File permissions

UNIX design expects individual users to log in to workstations with their own user IDs and passwords. The file permissions method used is predicated on classifying the user into one of three categories. Each file in UNIX is then flagged with certain permissions based on the category of the user. The individual login is required to properly place a user in the categories. A user will belong to each of these categories:

- ♦ **World**—Every user is a member of this category. Permissions granted to the world would be granted to any user on the UNIX workstation.
- ♦ **Group**—Every user should be a member of at least one group. Permissions granted to the group are granted to all the individual users in that group.
- ♦ **Owner**—Every user will own (create) some files. The permissions granted to the owner apply to the user who is the file creator. File ownership can also be changed after creation.

Passwords and user information are stored in the */etc/passwd* file. If shadow passwords are used, the passwords are stored in the */etc/shadow* file. Group membership is stored in */etc/group*. A user may be in more than one group. Only the administrator can create new groups or add and delete group members.

Figure 5-1 provides a sample listing of assigned file permissions.

Field 1: a set of ten permission flags.
Field 2: link count (don't worry about this)
Field 3: owner of the file
Field 4: associated group for the file
Field 5: size in bytes
Field 6-8: date of last modification (format varies, but always 3 fields)
Field 9: name of file (possibly with path, depending on how ls was called)

Figure 5-1: UNIX file permissions

Now that the users are categorized as World, Group, and Owner, you need to put flags on each file to correspond to the user category. The flags may also be used for more than just permissions. The permission flags are read left to right, as shown in Table 5-1.

Table 5-1
File Permission Flags

<i>Position</i>	<i>Permission or Type</i>
1	Not a permission, the first flag is the file type, <i>d</i> if a directory, <i>-</i> if a normal file, <i>c</i> or <i>b</i> for special devices
2,3,4	Read, write, execute permission for Owner of the file
5,6,7	Read, write, execute permission for members of the Group assigned to the file
8,9,10	Read, write, execute permission for the World (any user)

A dash (-) in any position means that a flag is not set. The flags of *r*, *w*, and *x* are shorthands for *read*, *write*, and *executable*. When an *s* is in place of an *x*, it means the User ID (UID) bit is on. When a *t* is in place of an *x* the sticky bit is set. The sticky bit is used to protect the renaming or removal of files in a directory. If the owner of a directory sets its sticky bit, the only people who can rename or remove any file in that directory are the file's owner, the directory's owner, and the superuser.

If a world or group user can execute the file while the UID bit is on, the execution will run as though the owner is running the file. Any permissions or access granted to the owner is thus applied to that execution. There are some security concerns when creating an executable or script that has the UID bit set. All the normal access permissions that UNIX provides to limit a user might be circumvented if the user can execute a file owned by root with the UID bit set.

For a directory, the setgid flag means that all files created inside that directory will inherit the directory's group. Without this flag, a file assumes the primary group of the user creating the file. This property is important to people trying to maintain a directory as group accessible. The subdirectories also inherit the set-groupID property.

The sticky bit is used to ensure that users do not overwrite each other's files. When the sticky bit *t* is set for a directory, users can only remove or rename files that they own.

To read a file, you need execute access to the directory it is in and read access to the file itself. To write a file, you need execute access to the directory and write access to the file. To create new files or delete files, you need write access to the directory. You also need execute access to all parent directories back to the root. Group access will break if a parent directory is made completely private.

When a new file or directory is created, the file permissions will be set to the *umask* that is set in the user's environment. Because this is a mask, use XOR to determine the file permissions to be set. Typically, the default configuration is equivalent to typing **umask 22**, which produces permissions of `-rw-r--r--` for regular files, or `drwxr-xr-x` for directories. This can lead to giving read access to files such as saved e-mail in your home directory, which is generally not desirable.

Care must be taken when assigning a group or changing the group access on a file or directory. The `/etc/group` file should be checked to ensure that only the intended users are given access. Consider, also, that the administrator may change the group membership at a later date, giving more persons access to files assigned to a group.

Set UID

Normally, when a user executes a program, it is run with the user or group ID (U/GID) and the program has the same privileges and access as the user or group. The program can access the same resources permitted to the user or group. Any files created by the process are owned by the user.

However, there are times when the processes executed on the user's behalf need to have root privileges, not user privileges. A typical example is the mount process, which calls the kernel to mount file systems.

A process or program has the privileges of the owner of the program (as opposed to the user) when the set UID (SUID) flag is set on the program's file permissions. As a security measure, only root is permitted to set the UID flag.

The following series of commands demonstrates the setting of the Set UID flag on an executable. First, you see from the long listing of the file that the permissions are set to `rwXr-x` `r-x` and no set UID flag is set.

```
# ls -l fake_exe
-rwxr-xr-x  1 root  root           0 Jun 13 12:25 fake_exe
```

Now the mode is changed to set the UID flag. You then see from another long listing that the **chmod** command has set the UID flag and the file permissions are now `rws` `r-x`.

```
# chmod +s fake_exe

# ls -l fake_exe
-rwsr-sr-x  1 root  root           0 Jun 13 12:25 fake_exe
```

The ability of a user to run a process with root powers is a definite security concern. System administrators should keep track of all applications with the UID flag set. Programs that set the UID to root are a potential avenue for users or attackers to gain root access. Table 5-2 shows a search of all files on a UNIX workstation that has the UID, GID, and sticky bit set.

Table 5-2
UID, GID, and Sticky Bits

<i>Files with UID Flag Set</i>	<i>Files with GID Flag Set</i>	<i>Files with Sticky Bit Set</i>
# find / -perm +4000	# find / -perm +2000	# find / -perm +1000
/usr/bin/chage	/tmp/app	Read, write, execute
/usr/bin/gpasswd	/usr/bin/wall	permission for Owner of
/usr/bin/chfn	/usr/bin/write	the file/dev/shm
/usr/bin/chsh	/usr/bin/lockfile	/var/lib/texmf
/usr/bin/newgrp	/usr/bin/slocate	/var/tmp
/usr/bin/passwd	/usr/bin/kdesud	/var/run/vmware
/usr/bin/at	/usr/sbin/lockdev	/var/spool/vbox
/usr/bin/rcp	/usr/sbin/sendmail.sendmail	/var/spool/samba
/usr/bin/rlogin	/usr/sbin/utempter	/var/spool/cups/tmp
/usr/bin/rsh	/usr/sbin/gnome-pty-helper	
/usr/bin/sudo	/usr/sbin/postdrop	
/usr/bin/crontab	/usr/sbin/postqueue	
/usr/bin/lppasswd	/sbin/netreport	
/usr/bin/desktop-create-kmenu		
/usr/bin/kcheckpass		
/usr/lib/news/bin/inndstart		
/usr/lib/news/bin/rnews		
/usr/lib/news/bin/startinnfeed		
/usr/libexec/openssh/ssh-keysign		
/usr/sbin/ping6		
/usr/sbin/traceroute6		
/usr/sbin/usernetctl		
/usr/sbin/userhelper		
/usr/sbin/userisdntcl		
/usr/sbin/traceroute		
/usr/sbin/suexec		
/usr/X11R6/bin/XFree86		
/bin/ping		
/bin/mount		
/bin/umount		
/bin/su		
/sbin/pam_timestamp_check		
/sbin/pwdb_chkpwd		
/sbin/unix_chkpwd		

To minimize the risk of a program with the UID flag set, the system administrator should decide if non-root users need to run the program. For example, a case can be made that normal users do not need to test network connects using applications such as ping and traceroute.

Chroot

The **chroot** command runs a service with an alternative root directory. For example, if the DNS bind service was launched with chroot under the alternative directory of */opt/dns/*, when the bind process refers to the */* directory, it will really be accessing the */opt/dns/* directory. The bind configuration file, normally at */var/named.conf* will need to be copied to */opt/dns/var/named.conf*. The same is true for all files (libraries, executables, and data) that bind will need to run.

The security gains are well worth the effort of setting up the alternative root directory. Now, if compromised, the service will only have at risk the files in the alternative root directory and all subdirectories. The service cannot “see” above the alternate root directory and neither will the attacker. This can be a huge security advantage, because only the minimal number of supporting files needs to be put in the alternative root directory tree to support the service. This limits the data that the attacker has access to. Also, if the service is compromised, the attacker is less likely to be able to spread the attack to other services on the host.

The service is launched by **chroot** with the following command:

```
chroot <alternative root directory> <service with command line options>
```

The alternative root directory setup is not trivial. Any supporting file that the service will need must be copied into the new data structure. This may include a reduced */bin*, */usr/lib*, and */usr/local*, among others.

Root access

Recall from earlier discussions on the kernel that UNIX has only two modes: supervisor (root) and normal (user). In this scheme, root has complete control and access over the entire workstation. For the user, on the other hand, not only is their access restricted, but if a user-run application attempts to access memory that is restricted to root access, a segmentation fault will occur stopping the attempt.

It should, therefore, be obvious that attacks on a UNIX workstation focus around getting root access. To reduce the risk to the workstation, system administrators should be reluctant to provide root access to users. Following are some of the problems that can arise if a normal user has root access:

- ♦ Users with root access can change the configuration of the workstation and potentially alter the security controls that the system administrator put in place. For example, a particular service may have been set up to only run in an alternative root directory with chroot. If a user unknowingly launches the service from the command line, this chroot protection will be lost.
- ♦ Users may launch services that open the workstation up to potential attacks. For example, Web servers are high-visibility targets and require significant hardening and configuration to be secure. The typical user will not apply the needed level of security for their locally run web server.

- ♦ Simple mistakes made by the user can be magnified. Every administrator at one time or another has lost track of the directory they were in and inadvertently run the following command: `rm -rf *`. This, if you don't recognize it, will delete every (non-hidden) file in the current directory and recursively into all subdirectories, without question. Generally, administrators learn these lessons early on and such control (power) is safe in their hands. However, this may not be the case for the average user. This example is the very kind of thing that can be minimized if the user is logged in as other than root. The user can still do a lot of damage, but it is usually self-inflicted and probably will not delete files owned and controlled by root.

Several steps can be taken to limit the use of the root account on a UNIX workstation. The following lists a couple of the key steps:

- ♦ **Limit access to the workstation directly as root**—All users should be required to log in to the workstation under their limited privilege user account and then **su** to root if they need to do root-level activities. This can be done by setting the root login shell to `/sbin/nologin` in the `/etc/passwd` file. The **su** command is sometimes referred to as the super user command because it allows a normal user to assume root-level privileges, assuming that the proper root password is provided.
- ♦ **Limit remote access to the workstation by root**—Services that permit remote login, such as `sshd`, should be configured not to allow root. The system administrator will have to log in as a normal user and then `su` to root. Each service has its own configuration method, but in the case of `sshd`, root access is controlled by adding the line `PermitRootLogin no` to the `/etc/ssh/sshd_config` file.

Denying root the ability to log in directly to the UNIX workstation has some important effects from a security perspective, as follows:

- ♦ The activity conducted by root can be attributed to an individual. The logs on the workstation will log the normal user's login and their transition to root via **su**. Should a problem arise from the activity, an individual can be queried to account for the changes made.
- ♦ If the root password is compromised and acquired by a normal user, they will not be able to use it to log in directly as root.
- ♦ Because any user must `su` to root to perform root-level activities, limiting the users that can run `su` can add a layer of protection. This is done by controlling which users are in the wheel group in the `/etc/group` file, because only these users are permitted to `su` to root. So, even if a normal user acquires the root password, they can be prevented from getting root access, through the `su` command, by not being put into the wheel group.

The protections discussed so far — limit root's direct access and control which users are in the wheel group — add significant security to the workstation. But these security gains can be reduced if every user is added to the wheel group

(granting every user the ability to `su` to root). This can easily happen if the average user needs to perform a relatively trivial root activity. A good example of this is mounting a cdrom or floppy. Because of one activity (mounting), all users might be given root-level access (put into the wheel group). This is obviously a security risk. The solution to this problem is the `sudo` command.

The **sudo** command allows normal users to execute certain commands that would normally be limited to root. In the case of mounting a floppy, the command would be as follows:

```
sudo mount /dev/fd0 /mnt/floppy
```

Now certain users will be able to execute a limited number of root-level commands. The system administrator controls which users and which commands can be run by `sudo` through the configuration file `/etc/sudoers`.

Encryption and certificates

The defense-in-depth strategy toward security requires system administrators to take every possible action to improve security. One significant improvement to security can be obtained by widespread use of encryption. With respect to the UNIX workstation, the following are security advantages to be gained:

- ♦ If a workstation gets compromised and taken over by an attacker, previously encrypted files are likely to be protected. This assumes that passphrases used to encrypt the data are kept in the users' memory and not on the workstation.
- ♦ By encrypting traffic on the local area network (LAN), the risk of being attacked from a local source is greatly reduced. Many organizations consider their biggest security feature to be the firewall between the LAN and the Internet. However, other workstations on the LAN also pose a significant threat. For example, if the LAN is hubbed, any workstation can listen in on all instant messaging to and from another workstation. Even if the network is switched there are readily available tools, such as `ettercap`, that can monitor all traffic in and out of a workstation.
- ♦ Much of the traffic that travels over the Internet, such as e-mail or FTP, is in the clear or unencrypted. The only protection afforded to this traffic is security through obscurity. In other words, the telnet, e-mail, and FTP traffic can be read in many places as the traffic is routed, but who would want to? Most users would not find this level of security very comforting.



Encryption is covered in detail in Chapter 14.

Like most things in life, the decision to use encryption is based on a cost-benefit analysis. The benefits are huge. Because encryption is getting easier to implement the cost is certainly being reduced. It is now reasonable for an organization to encrypt all telnet, e-mail, and FTP traffic.

GNU Privacy Guard

GNU Privacy Guard (GPG) is a UNIX implementation of the popular and robust Pretty Good Privacy (PGP) encryption program by Phil Zimmerman. Files encrypted by one can be decrypted by the other (and vice versa). GPG is free and available for all versions of UNIX.

GPG is most commonly used to encrypt files and e-mail messages. E-mail clients, such as Evolution, integrate well with GPG. If an e-mail client does not support GPG integration, the messages must be saved as a file before decrypting.

GPG uses the public-key method of encrypting data. Public-key encryption (also called asymmetric encryption) involves a pair of keys — a public key and a private key — associated with the user. A user's public key can be widely distributed and used to encrypt a file or message being sent to the user. The user then uses his or her private key and a passphrase to decrypt the file or message. In simple terms, a file encrypted with the public key can only be decrypted with the private key, and vice versa.

In addition to encrypting files and messages, GPG can be used to sign an e-mail message. A signed message allows the recipient to verify the sender. The recipient can verify that the message was signed with the sender's private key.

Users must protect their passphrase and private key. Both are needed to decrypt a file or message. If a user's private key is stolen, an attacker could attempt a brute force attack on encrypted data. Therefore, a strong (hard-to-guess) passphrase is also important. If someone obtains a user's private key and passphrase, the person would be able to impersonate the user in e-mail traffic.

The Secure Shell program

The Secure Shell (ssh) program supports logging into and executing commands on a remote machine. It is intended to replace rlogin and rsh and provide secure encrypted communications over a network. XWindows connections and TCP/IP ports can also be forwarded over the secure channel.

The ssh application uses public-private key technology to exchange a session key. All the ssh traffic is then encrypted with the session key.

The ssh application can be used to forward ports through the secure tunnel. The following is an example of using ssh to secure the transfer of e-mail to and from a mail server. The command is shown spanning multiple lines, to aid in this discussion.

```
ssh -l user1 \  
-L 110:smtp.somedomain.org:110 \  
-L 25:smtp.somedomain.org:25 \  
smtp.somedomain.org
```

The first part of the command calls `ssh` with a `-l` (ell) option that gives the user name to be used to log into the mail server. The next option, `-L`, designates that port 110 on the local host should be forwarded to the POP3 port 110 on the `smtp.somedomain.org`. This means that to retrieve e-mail with the POP protocol from the remote host, the user only needs to retrieve e-mail from the local 110 port. In a similar manner, the SMTP port 25 is also forwarded. And, finally, the host to which the `ssh` session connects is given.

The `scp` command copies files between hosts on a network. This command uses `ssh` for data transfer, and uses the same authentication and provides the same security as `ssh`. The user's password is required for `scp`. The syntax for `scp` is as follows:

```
scp -r smtp.somedomain.org:/var/spool/mail/user1 /tmp
```

In this example, `scp` copies the mail box of `user1` from the host `smtp.somedomain.org` to the local directory of `/tmp`.

Hardening UNIX

Any workstation connected to a network needs to be hardened against attack. Following are some general principles that should be applied when hardening a system:

- ♦ Assume that default installations of any distribution will be inherently unsafe until hardened.
- ♦ Limit software, processes, and access to the minimum needed to perform the mission of the workstation.
- ♦ Use more secure alternatives to insecure services (such as using `ssh` instead of `telnet`).
- ♦ Keep current with security patches and upgrades for software packages.
- ♦ Use `iptables` to back up the hardening of the workstation.

Configuration items

Hardening an operating system usually consists of many small steps. Here are some that apply to UNIX workstations:

- ♦ Run high-visibility services accessed from the network as `chroot`, if possible. Recall the earlier discussion on `chroot`. Good candidate services are Domain Name Server (DNS) and Web servers.
- ♦ Disable unneeded services.

- ♦ Remove unneeded software packages.
- ♦ Run iptables to filter traffic coming in from the network.
- ♦ Set nosuid, noexec, nodev in */etc/fstab* on ext2 partitions, such as */tmp*, that are accessible by everyone. This reduces the risk of a Trojan horse attack.
- ♦ Use strong passwords. In a nutshell, a strong password is not based on common words and cannot be cracked with a brute force attack (in a reasonable amount of time).
- ♦ Enable password shadowing.
- ♦ Configure */etc/login.defs*. Among other things, the following can be set:
 - PASS_MAX_DAYS—Maximum number of days a password may be used.
 - PASS_MIN_DAYS—Minimum number of days allowed between password changes.
 - PASS_MIN_LEN—Minimum acceptable password length.
 - PASS_WARN_AGE—Number of days warning given before a password expires.
- ♦ Add a wheel group to designate which users are allowed to **su** to root.
- ♦ Disable root logins and have administrators use **su** to get root access.
- ♦ Limit TTY and root access in */etc/security/access.conf*.
- ♦ Set limits in */etc/security/limits.conf*. Limits can be assigned to individual users or by groups. Items that can be limited include the following:
 - core—Limits the core file size (KB)
 - data—Maximum data size (KB)
 - fsize—Maximum filesize (KB)
 - memlock—Maximum locked-in-memory address space (KB)
 - nfile—Maximum number of open files
 - rss—Maximum resident set size (KB)
 - stack—Maximum stack size (KB)
 - cpu—Maximum CPU time (MIN)
 - nproc—Maximum number of processes
 - as—Address space limit
 - maxlogins—Maximum number of logins for this user
 - priority—The priority to run user process with
 - locks—Maximum number of file locks the user can hold

- ♦ Disable root and anonymous FTP access in */etc/ftusers*.
- ♦ Protect log files by limiting access to root. Log files are an important means to detect and counter an attack. The early stages of an attack often deal with deleting and disabling logging. Consider setting up a loghost and have critical systems send their logs to a central log server for greater protection and monitoring.
- ♦ Consider burning operating system and services on a CD and boot from that CD. This is only practical for stable non-changing servers.
- ♦ Disable remote X by adding `--noListen tcp` to the X command line (usually `startx`).
- ♦ Train system administrators and users on security issues and attack prevention.

TCP wrapper

TCP wrapper can be a powerful tool for the system administrator to minimize the risk of an attack. Here is how www.cert.org describes this tool.

Servers on UNIX systems usually either provide their services via the TCP/IP protocol stack to everyone or no one. In addition to this conceptual weakness, logging of connections is minimal and does not include, for example, source or timestamp. Connection attempts can be an early warning signal that a site is under attack so you want to capture as much information as possible.

Tcpd, the program implementing the tcp wrapper, was developed as a result of an actual attack. It provides (1) some level of access control based on the source and destination of the connection request and (2) logging for successful and unsuccessful connections. tcp wrapper starts a filter program before the requested server process is started, assuming the connection request is permitted by the access control lists. All messages about connections and connection attempts are logged via `syslogd`.

Checking strong passwords

To protect the network from attacks, a system administrator can verify that strong passwords are in place. What defines a strong password is discussed in detail in Chapter 3. The most effective way to test passwords is to run a password-cracking program against the workstation.

A number of good password-cracking applications are easily acquired. The site www.redhat.com reports on the following password crackers:

- ♦ **John The Ripper**—A fast and flexible password-cracking program. It allows the use of multiple word lists and is capable of brute-force password cracking. It is available at www.openwall.com/john/.

- ♦ **Crack**—Perhaps the most well-known password-cracking software, Crack is also very fast, though not as easy to use as John The Ripper. It can be found at www.users.dircon.co.uk/~crypto/index.html.
- ♦ **Slurpie**—Slurpie is similar to John The Ripper and Crack except it is designed to run on multiple computers simultaneously, creating a distributed password-cracking attack. It can be found along with a number of other distributed attack security evaluation tools at www.ussrback.com/distributed.htm.

Packet filtering with iptables

As the last line of defense against an attack from the network, the UNIX workstation can run a host-based firewall, such as iptables. iptables is a packet filter that works off rules controlling packets on the input, output, and when they are forwarded through the interfaces.

A packet filter such as iptables will examine the header of packets as they pass through and process the packet in one of three ways, as follows:

- ♦ **Deny the packet**—Discard the packet with no trace of having received it.
- ♦ **Accept the packet**—Let the packet go through.
- ♦ **Reject the packet**—Similar to deny, but the sender is notified that the packet was rejected.

Although iptables is a fully functional firewall, its use is discussed here as a host-based or personal firewall. The use of iptables as a network firewall is discussed in Chapter 13. The typical iptables configuration for a UNIX workstation is as follows:

- ♦ Allow all network-bound traffic to leave the workstation. Generally, outbound traffic does not pose a threat to the workstation itself. It may be advisable to limit outbound traffic to prevent the spread of viruses and worms. Unfortunately, these often function similarly to how a user might (sending e-mail, for example) and are, therefore, difficult to block on the outbound path.
- ♦ Block all incoming traffic that is not specifically allowed. With only a few exceptions, the world (everyone coming in from the network) does not have a need to reach ports on the workstation.
- ♦ Explicitly open individual ports (services) that are needed from the network. On a UNIX workstation, this is usually just ssh (port 22) for remote access, but even that may not be needed. Other typical services that might be allowed are usually on dedicated servers, such as HTTP Web service (port 80), FTP file transfer (port 21), and SMTP e-mail (port 25).

The second configuration item in the preceding list (“block all incoming traffic”) is the key defense-in-depth backup to other security preparations taken on the UNIX workstations. Unneeded services should not be running, but if they are, they can still be blocked from use by the network with iptables. Unneeded software should

not be available on the workstation, but if it is found and launched as a service by an attacker, it can still be blocked by iptables.

Summary

UNIX is a very powerful operating system that can be either very secure or very vulnerable, depending on how it is configured and operated. Some factors that make UNIX a good operating system for security are as follows:

- ♦ The source code for the operation system is available for scrutiny and analysis. This can lead to fewer vulnerabilities in the operating system and applications running in UNIX. In the case of some open source operating systems, such as Linux, the user community can fix flaws in the code and recompile or rebuild the system.
- ♦ The flexibility and configurability of UNIX support the administrators' need to harden the workstation against attack.
- ♦ UNIX operators tend to be more experienced and technical and, therefore, should be less vulnerable to attack.

Following are some reasons why UNIX can be more vulnerable as an operating system:

- ♦ Hackers are able to study the source code for the operating system and most applications and find flaws in the code. The hackers can thereby focus their efforts and potentially produce more exploits.
- ♦ Most servers on the Internet are running UNIX of one form or another. This makes it a favorite target for hackers.
- ♦ Many hacking tools have been developed on UNIX, so these tools are more likely to work against UNIX workstations from day one.



Web Browser and Client Security

Web browsers provide the face—the convenience and productivity—of the Internet. The vast majority of Internet users spend all of their time with two applications—the e-mail client and the Web browser. Web browsers provide everything that has made the Internet useful and productive for millions of people.

Web Browser and Client Risk

In many ways, Web browsers are the ultimate in computer convenience. The Internet started out as an academic information exchange enabler. Then Web browsers made the Internet easy to use and allowed noncomputer-savvy companies and individuals to harness the power of information exchange and remote processing. Ever since the inception of the easy-to-use and pleasant-to-view Web browser, the Internet has taken off. In a few short years, it has landed in nearly every business and most homes throughout the United States.

The convenience, productivity, and popularity of Web browsers make them a prime target for hackers and would be attackers. As the convenience of a product increases, so does the security risk, so Web browsers by their very nature should be expected to be risky. The productivity of the Web browser also makes it a prime target for attacks because the hacker can get the biggest bang for the effort put forth. Finally, the popularity of a product plays into the hacker's hands by increasing the scope of any attack or vulnerability discovered. The hacker who develops an attack for a common Web browser is sure to find many susceptible targets.



In This Chapter

Exploring client risk from Web browser

Understanding Web browser operation

Known Web browser attacks

Operating a Web browser safely

Understanding Web browser configurations



Privacy versus security

More so than most applications on the typical user's workstation, the Web browser highlights the two related areas of concern — privacy and security. Security is concerned with the confidentiality, integrity, and availability of data. Privacy is concerned with the inadvertent disclosure of information. In some cases, this disclosure is to the result of a security breakdown in confidentiality. But in many cases, the privacy violation occurs when users unwittingly disclose personal information. The convenience and productivity of Web browsers can lull users into providing information that they would not normally give to total strangers.

Web browser convenience

As previously mentioned, with convenience comes security risks. This is very evident in the case of Web browsers. The first Web browsers only rendered HTML code and downloaded image files. This simple capability had some security risks that were not manifest until later years. Because most of these risks are a result of input and buffering vulnerabilities on the Web server, they are addressed in Chapter 7, “Web Server Security.”

Web browsers today provide a lot more features than simply rendering images and HTML code. Their convenience is greatly enhanced by their capability to do the following:

- ♦ Run Common Gateway Interface (CGI) scripts on the Web server
- ♦ Run scripts written in JavaScript or Visual Basic Script (VBScript) on the Web browser
- ♦ Run executables such as Java and ActiveX on the Web browser host
- ♦ Launch various plugins such as an audio player or movie player

In most cases, these conveniences come from a very tight integration between the Web browser and the operating system (or other applications). By far, the most convenient and integrated Web browser is Microsoft Internet Explorer. As such, it should also be viewed as having the most security risk. To date, Microsoft has emphasized convenience over security. Therefore, users should expect that out-of-the-box configurations of Internet Explorer will be configured for user convenience. A security-minded user will want to examine this configuration and perhaps improve the security of the application.

Web browser productivity and popularity

Convenience may introduce security risks into Web browsers, but it is the productivity and popularity of the browser that makes us susceptible to these risks. It is a Web browser's productivity that keeps users coming back to this application.

The more an application is used for critical or sensitive work, the greater the potential security risk to the user. Some of the most sensitive work users do on their workstations is done through Web browsers. Often users will do banking, credit card purchases, shipping to a home address, and hobby pursuits. The data involved in any of these activities would be of interest to an attacker.

But to be a prime target, an application must be more than just convenient and productive—it must be popular, meaning widely distributed and used. Hackers will focus their efforts on applications that will provide them with the largest source of potential targets. Figure 6-1 illustrates the unique combination of convenience, productivity, and popularity that makes a Web browser a favorite target for security attacks.

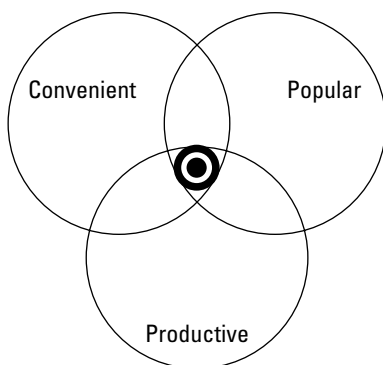

Figure 6-1: Convenient, productive, and popular applications become targets.

Web browser evolution

Web browsers, like most Internet applications, respond to emerging security threats. In the early years, Web browsers were very vulnerable. They had features making them convenient and productive but had no means for the user to make them more secure. Web browsers have evolved (due to the security threat) to a customizable application. Users are now able to set various configuration items to improve the security of their Web browsers.

The problem with highly customizable Web browsers, as a security measure, is that most users are not sophisticated and savvy when it comes to securing a Web browser or even understanding the threat. Often users will not change any of the browser's security configuration items. The customization, for security purposes, is then left to the system or network administrator. However, as discussed earlier, browsing has become such an accepted norm for convenience and productivity that few users will

tolerate less than total functionality. As a result, administrators that initially attempt to secure browsers are often beaten back by the onslaught of complaints and requests for help. In the end, the administrator must relax the Web-browsing security settings.

Web browser risks

The security risks associated with using a Web browser can be grouped into several categories:

- ♦ **The Web server may not be secure.** All the data that users enter into their browsers is ultimately processed on the Web server. In most cases, this information is stored in a database of some sort. Most typical users assume that a professional organization that is providing the service is security conscious. However, the opposite is probably true (as discussed in detail in Chapter 10). The best defense a user can have against an insecure Web server is to limit the sensitive data that is transmitted to the server.
- ♦ **The browser runs malware in the form of scripts or executables.** The Web browser is a convenient and powerful tool that makes the user's life easier by running scripts and (in some cases) executables for the user. However, this feature could be abused and malware could be run instead of useful routines.
- ♦ **An attacker may eavesdrop on network traffic.** Users should be aware that the security of the data transmitted to and from the Web server is no more secure than the security of the network on which it travels. This risk can be reduced when the Web server uses Secure Sockets Layer (SSL) to encrypt the data transmitted and received.
- ♦ **An attacker may employ a man-in-the-middle attack.** Sessionless Web-based applications, such as a Web server are potentially susceptible to man-in-the-middle attacks such as hijacking and replay.

Session hijacking and replay occurs when traffic between the browser and server is observed and captured by a network sniffer. In the case of hijacking, the attacker modifies the captured traffic to allow the man in the middle to take the place of the client. All future traffic in the session is now between the Web server and the attacker. For the replay attack, some aspect of the session may be modified. Certain replays, such as transferring bank funds, may not require modifications. The modified session is then fed back onto the network. As a result, the Web server is fooled into believing that the replayed transaction is a legitimate action by an authorized user, clearly a security problem.

Issues working against the attacker

Almost every browser and operating system combination is vulnerable, but a couple of factors work in the browser's favor. The following are some factors that slightly reduce the risk to the user:

- ♦ **The attacker cannot choose the time and place.** The nature of a Web browser and server interaction requires the user to come to the server. In the vast majority of cases, the server does not know who or when a user will connect with the server. This makes the planning of an attack slightly more difficult. It is very difficult for an attacker to focus on one particular individual. Because the attacker cannot specifically target their victim, they have to take a victim of opportunity.
- ♦ **The attacker probably does not know the victim.** Because the attacker does not know who the victim will be, they may attack a sophisticated user and get discovered very quickly.
- ♦ **Browsers can vary.** Although there are two major browsers (Netscape and Internet Explorer), there is a fair amount of variety in the versions of each that are commonly deployed. An attack for one particular browser version may not be a risk to users using a different browser.

How a Web Browser Works

Understanding how the browser and server work together can be helpful in understanding the need for security.

HTTP, the browser protocol

Hyper Text Transfer Protocol (HTTP) is the main protocol of Web browsers. HTTP is the application layer protocol that enables the Web browser to request Web pages and send information (usually in forms) to the Web server. The Web server responds to the request and typically returns the following:

- ♦ **Hypertext Markup Language (HTML) code**— This is the code that provides the basis for everything that a Web browser typically displays. This code is interpreted by the Web browser to display text in various forms and orientations. This code also has placeholders for scripts and links to images and perhaps executables. When a page is downloaded, the Web browser interprets the HTML code for further requests to be made. For example, when an image is to be downloaded, it typically is embedded in the HTML code. The Web browser recognizes the embedded link to the image and automatically sends another request to the Web server to get the image. After the image is returned by the Web server, the Web browser renders the image in the same location as the link.

- ♦ **Images**—An image can be requested directly by the user, or the Web browser can interpret a link in a downloaded page and send a request to the Web server. The image is returned in a file format. The Web browser must know how to render the file type. Typical image file types are GIF, JPEG, BMP, and TIFF, but there are many possibilities.
- ♦ **Scripts**—Scripts are typically embedded in the HTML code. The Web browser extracts the script from the HTML and runs the script. There are a number of scripting languages and the Web browser must know how to interpret the scripts. Some typical scripting languages include JavaScript, PerlScript, and Visual Basic Script.
- ♦ **Executables**—The Web browser can download and launch executables. This obviously is a security risk, because most Web servers are managed by strangers to the Web-browsing user. It is ironic that users who would closely guard their workstations from strangers would also download and run executables written by strangers.

In theory, there is no limit to the type of information that can be passed between the Web browser and the Web server. All that is required is that the Web browser and Web server agree as to how a particular file type will be interpreted.

The most unusual feature of HTTP is that it is a “stateless” protocol. Essentially, each browser request and server return is a separate TCP connection. This is not at all intuitive to the user, because the Web browser and server work in concert to give the user a “feel” of continuity during a session. *Session* in this chapter is a loosely defined term meaning a whole series of transactions (requests and responses) that are logically tied together in the user’s mind. Table 6-1 shows the difference between what the user thinks is happening and what is really occurring between the browser and server.

Table 6-1
A Simple HTTP Session

<i>User Perception</i>	<i>Browser and Server Activity</i>
User opens the Web browser, types <code>www.my-family.tmp</code> into the navigation window, and presses Enter.	The following steps are taken by the Web browser to ultimately display the Web page that the user expects.
The Web page is displayed with some text and family photos.	<ol style="list-style-type: none"> 1. The browser contacts a domain name server to get the IP address of <code>www.my-family.tmp</code>. The browser uses IP addresses when communicating on the Internet, not the domain name itself. 2. The Web browser opens a TCP connection to the IP address on port 80. This is similar to telnetting to that IP address on port 80. The Web server is listening for the connection. 3. The Web browser sends the initial request to the server, such as follows: <pre>http1.1 GET /</pre> <p>The slash (/) is used in the initial request because no subdirectory was given by the user.</p> 4. The Web server looks in the document root directory (/) and most likely sends the ASCII file <code>index.html</code> back to the Web browser.
The user sees the Web page starting to display. Typically, this starts with a color change or the rendering of some initial text.	<p>As the <code>index.html</code> file is downloaded, the Web browser interprets the HTML code for display parameters such as the following:</p> <ul style="list-style-type: none"> – The Web page size and color is set. – The browser displays any text with appropriate formatting, such as bold or centered. – Any scripts, such as JavaScript, are extracted from the HTML code and associated with a button or mouse movement. – The Web browser parses through the HTML code looking for links to other files to download. In this example the browser finds links to images.

Continued

Table 6-1 (continued)

User Perception	Browser and Server Activity
The user sees images being downloaded and displayed.	The Web browser parses all the links to images in the HTML code and submits a separate request to the Web server for each image.
The Web browser is interpreting the initial HTML downloaded and requesting the images. But from the user's perspective, the images seem to come down with the original response.	Note that the Web server has not sent the images down with the <i>index.html</i> page. It is the Web browser's responsibility to interpret the HTML code and request the images.

From the session described in the table, you see that the Web server sends an initial web page (*index.html*) and sends the subsequent images as they are requested by the Web browser. Note that the Web server does not control when the images are sent, the browser does. In fact, the Web server does not even anticipate the sending of the images. This is because, to the Web server, the request for the images is completely separate from the request for the initial page (*index.html*). The Web server does not maintain a state of what the Web browser (or user) is doing. It merely responds to requests in any order that the Web browser sees fit to request them. This is what is meant by the HTTP protocol being stateless. Each and every piece of a Web page is a separate connection or transaction (request and response).

Cookies

A *cookie* is an information storage device created by a Web site to store information about the user visiting that site. This information is stored for the convenience of the Web site or for the convenience of the user. In any case, the retention of potentially sensitive or private information is a possible privacy concern.

A cookie is simply an ASCII file that the server passes to the client and the client stores on the local system. When a new request is made, the server can ask the browser to check if it has any cookies and, if it does, to pass those cookies back to the server. The browser can potentially pass *any* cookie to a Web server. This could include cookies from completely different Web sites.

The contents of the cookie are under the control of the Web server and may contain information about you or your past and present surfing habits. Originally, the information that the Web server has come from the Web browser. When a user fills out a form that asks for a name and e-mail address, that information is sent to the Web server, which may store it in a cookie for future use.

There are two general types of cookies: persistent and nonpersistent. A persistent cookie is one that will survive reboots and last for a fairly long period of time. Persistent cookies are traditionally stored on the hard drive in a file such as *cookies.txt*. This file can be read and edited by the user or system administrator. This file may contain sensitive data unbeknownst to the user. If at some future date the workstation is compromised, an attacker can use this sensitive data in subsequent attacks. Because the cookies file can be modified, it is also susceptible to being used in a hijacking or replay attack.

Cookies originally were intended to track users during their sessions on a Web site, or to retain information about users between visits to the Web site. However, persistent cookies build up on a user's workstation over a long period of time can comprise a detailed history of the user's activities on the Internet. In the past, some marketing companies have attempted to exploit user behavior by trying to capture these persistent cookies.

As a result of concerns, more and more people are wary of cookies, especially those that can be used to track users over time. Therefore, many sites are starting to use nonpersistent cookies. A nonpersistent cookie is stored in memory, so when the computer is turned off or rebooted the cookie information is lost. There is no assurance that every browser will handle nonpersistent cookies correctly. The Web server has no control over how the browser stores or disposes of the cookies. The Web server can tag a cookie as nonpersistent, but then has to trust that the Web browser will honor the tag.

For maintaining state purposes, nonpersistent cookies would work just fine, because you only need to track a user during a session, which will not span a reboot of the workstation.

Cookies generally contain information that allows the Web site to remember particulars about users visiting the site. A popular scheme is to include the following information in cookies:

- ♦ **Session ID**— This is typically used to maintain state or carry authorization information forward between browser requests.
- ♦ **Time and date the cookie was issued.**
- ♦ **Expiration time and date**— This can be used by the Web site to determine if this is an old cookie that should be ignored.
- ♦ **The IP address of the browser the cookie was issued to**— This can serve as an additional test of the authenticity of the request.

Maintaining state

A Web-based application that deals with sensitive data has three major security issues to address in its design and development:

- ♦ **Initial authentication** — When needed, authentication is usually done with a username and password. As long as a strong password is used and the network data is encrypted, the initial authentication can be made secure.
- ♦ **Confidentiality of data** — This is usually done with encryption. With a sufficiently strong encryption technique, only the legitimate recipient of the data should be able to decrypt the traffic.
- ♦ **Continuing authentication of users over an extended session** — Also known as maintaining state, this is the biggest risk for a Web-based application such as a Web server. The reason the risk is high is that there is no normal or preferred method to provide continuing authentication of users over an extended session. Off the shelf, Web servers do not provide a secure means for a Web site developer to maintain state securely.

The continuing authentication of a user over an extended session is done as a matter of convenience for the user. Without the continuing authentication, the user would have to provide a user name and password for *every* request submitted to the Web server. In other words, as users navigate the various Web pages of the application, they would be constantly entering a user name and password. For a typical Web page, this could mean providing the user name and password hundreds of times an hour (recall from earlier discussions that every image is a separate request and response).

For a Web server to be useful and convenient to a user, it must interact with the user much as an intelligent clerk or sales person would. To act intelligently, the Web site should do the following:

- ♦ **Remember user-specific information.** The Web site should not ask for the same information twice. When provided a user's name and address, the web site should remember this information from one page to the next.
- ♦ **Remember decisions the user has made.** If the user has set some preferences (such as sort by lowest price) the Web site should remember these preferences during the user's entire session.
- ♦ **Remember intermediate results.** The typical example of this is the shopping cart. As users select items to purchase, they can store these items in a shopping cart until they decide to check out and purchase the items. Clearly, the Web site needs to remember the items in the shopping cart while the user navigates around the site.

- ♦ **Remember where the Web site and the user are in a “conversation.”** As users navigate a site, the Web server needs to know where they are and how they got to that location. For example, certain locations on the Web site may require password authentication. The server needs to know if a user has previously successfully authenticated during this session before allowing access to these pages.

Remembering all this state information means that data will have to be passed from Web page to Web page. There is no usual method of maintaining state. The burden of continuing authentication is left up to each Web site implementation. As a result, some sites will be secure, but many will not. Most Web site developers focus on performance and content, not security. Therefore, many schemes that are implemented for maintaining state are ideal for user convenience but might be susceptible to attacks.

Because HTTP is sessionless, the Web server does not carry an authentication forward from one page to the next. The Web site developer must use what is at hand to maintain state. The three common means of continuing authorization (carrying session data forward) are as follows:

- ♦ **GET lines**—The GET line holds the Universal Resource Locator (URL), which is the Web site requested by the user (such as `www.my-family.tmp`). In addition to the domain name and directory requested, other information can be passed on the GET line. This information is passed in the form of `? <variable> = <value>`. Consider the following GET line, which conducts a Yahoo search on the keyword of “linux”:

```
http://search.yahoo.com/search?p=linux
```

In this case, Yahoo uses the variable `p` and the data passed is `linux`.

- ♦ **POST data**—In addition to the GET line, variable information can be passed from the browser to the server with a POST command. These variables and their data are not so easily seen by the user because they are transmitted behind the scenes. POST data is slightly more difficult to acquire and modify. However, you can easily write a tool to do so within a couple of hours. The SSL encryption would prevent the modification of POST data but would still leave open the possibility of session replay. The form used for POST data is in the HTML code as a hidden form element. Because the information is marked hidden, the browser never displays it. The values can be seen with a network sniffer, but if viewed through the browser, the information is not displayed.
- ♦ **Cookies**—Information is put into a cookie by the Web server and passed to the Web browser. The Web browser then returns the information to the Web server with subsequent requests. Cookies are easily acquired and modified, both on the user’s workstation and on the network. You will see later in this chapter that cookies used for maintaining state are susceptible to hijacking and replay attacks.

Caching

When you access a Web site, your browser may save pages and images in a cache. Web browsers do this for the convenience of the user by improving the speed at which Web pages are rendered. However, all these pages and images are stored on the workstation's hard drive as HTML files and image files. The user or system administrator can load and view these pages and images without the need to be on the network or to go back to the original site. This can be a privacy concern, because if the workstation is compromised, the attacker can learn details of a user's browsing.

The Web browser also maintains a history of sites visited. If you do not clear the cache and history files, anyone can view the sites accessed simply by using the back button on the browser.

Secure Socket Layer

The Secure Socket Layer (SSL) protocol provides for the encryption of the traffic between the Web browser and server. SSL uses public-key encryption to exchange a symmetrical key between the client and server; this symmetrical key is used to encrypt the HTTP transaction (both request and response). Each transaction uses a different key. If the encryption for one transaction is broken, the other transactions are still protected.

The following are the benefits of encrypting Web-based communications:

- ♦ **The communications can travel over nonsecure networks.** The traffic between a browser and a Web server may traverse many networks as it travels across the country or around the world. It would be cost prohibitive for each Web site provider to ensure the security of all networks between the Web server and the user's browser. With encryption, the risk of a man-in-the-middle attack is greatly reduced because the attacker cannot decrypt the traffic (in a reasonable timeframe). This benefit assumes that SSL is properly configured and used.
- ♦ **The integrity of the data transmitted is maintained.** Encrypted data ensures the integrity of the data because the decryption process requires that not even one bit is "flipped" or out of place. If the encrypted data has been altered in any way, it will not decrypt properly. This allows a user to be sure that when they send someone an electronic check for \$100, it does not get altered to \$100,000.
- ♦ **The confidentiality of the data being transmitted is ensured.** If a third party is listening to the traffic between the browser and the Web server, they will only see the encrypted data. Assuming the encryption cannot be broken in a reasonable time, this ensures the confidentiality of the data.

- ♦ **The Web site's authentication can be enhanced.** The process of exchanging encryption keys and certificates can provide assurance that the browser is communicating with the proper Web site. The degree of security depends on the method used to exchange the key or certificate.

Netscape introduced the SSLv2 protocol in 1995, and the protocol has provided consumers with a secure means for conducting Web commerce. Additionally, Web-based applications that deal with sensitive or private data could now be made available to the general public. The growth of the Internet in the late 1990s probably would not have been possible without a secure and reliable protocol such as SSL.

Encryption can go a long way in maintaining the integrity and confidentiality of the data in a Web-based transaction. The price for encryption is performance or the cost of additional hardware and software. Additional hardware may be needed to increase the bandwidth and improve the performance of the Web server or application.

A typical SSL session

SSL is a low-level encryption scheme used to encrypt transactions in higher-level protocols such as HTTP, Network News Transfer Protocol (NNTP), and File Transfer Protocol (FTP). SSL is implemented commercially on all major browsers and servers.

To pass encrypted data, two parties must exchange a common key. The keys are exchanged using certificates and a handshaking process, shown in Figure 6-2. The handshaking process is as follows:

1. The browser or client requests a certificate from the server. In essence, a certificate is a set of fields and values encrypted into a small block of ASCII text. The certificate is encrypted to avoid tampering, thus ensuring its integrity.
2. The server provides its certificate. The server's organization has acquired the certificate from a reliable and trusted certificate authority. The certificate authority verifies that the server's organization is who they say they are. In other words, only the Microsoft Corporation should be able to get a certificate for "Microsoft."
3. Having received the certificate, the browser checks that it is from a reliable certificate authority (CA). The certificate contains the Web server's public key. The Web browser now sends a challenge to the server to ensure that server has the private key to match the public key in the certificate. This is important because someone who has the certificate could be pretending to be that organization. This challenge contains the symmetrical key that will be used to encrypt the SSL traffic. Only the owner (possessor) of the private key would be able to decrypt the challenge.
4. The Web server responds to the challenge with a short message encrypted with the symmetrical key. The browser now is assured that it is communicating with the proper organization and that the Web server has the symmetrical key.

- Both the browser and the Web server now share a common symmetrical key. No one other than these two parties knows what the key is, so the encrypted communications between them should be secure.
- Now any GET or POST sent from the browser can be encrypted with the symmetrical key. The Web server uses the same symmetrical key to decrypt the traffic.
- In the same manner, any response sent from the server is encrypted with the common symmetrical key and the browser can decrypt the traffic.

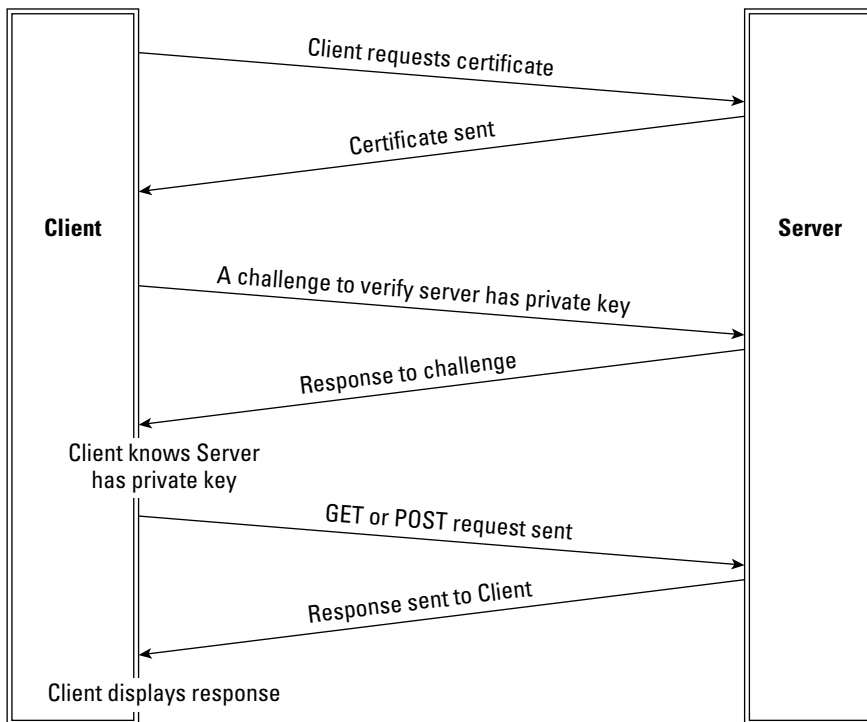

Figure 6-2: The SSL handshake process

Note that the SSL handshake process authenticates the Web server to the browser, and not vice-versa. This makes SSL more susceptible to a man-in-the-middle attack. During such an attack, the server would have no indication that there is a man in the middle. The browser or user will, however, have to accept a bad certificate for the attack to work. The security of the overall process would be greatly enhanced, if the Web server authenticated the client. The Web server would be less likely to accept a bad certificate, whereas unsophisticated users may not appreciate the risk they are taking by doing so.

A properly configured Web browser will warn the user of a certificate problem if any of the following occur:

- ♦ **The certificate was not signed by a recognized certificate authority.** Software is available in the public domain to create a rogue CA and generate illegitimate certificates.
- ♦ **The certificate is currently invalid or has expired.** Legitimate Web sites will keep their certificates up-to-date. This may indicate that the certificate has been stolen and is being used by a third party.
- ♦ **The common name on the certificate does not match the domain name of the server.** The host name of the Web server is a fixed part of the site certificate. If the name of the Web server doesn't match the name on the certificate, the browser will report the problem.

If a problem has been identified with the certificate, the user is prompted whether or not to accept the certificate. If the user accepts a bad certificate, he or she is exposed to a possible man-in-the-middle attack by someone impersonating the Web server.

SSL performance issues

The negative impact that SSL can have is on performance and cost. The following is from an SSL FAQ:

How will SSL affect my machine's performance?

The performance problems associated with most HTTP servers are CPU and memory related (this contradicts the common assumption that it is always the network which is the problem). The CPU has to process the HTTP request, write out HTTP headers, log the request and put it all on the TCP stack. Memory bandwidth is also a problem (the OS has to make a lot of copies to put packets onto the network). SSL makes this bottleneck more severe:

Bandwidth: SSL adds on average 1K bytes to each transaction. This is not noticeable in the case of large file transfers.

Latency: SSL with client authentication requires two round trips between the server and the client before the HTTP session can begin. This typically means at least a 500 ms addition to the HTTP service time.

Bulk Encryption: SSL was designed to have RC4 and MD5 in its cipher suite. These run very efficiently on a 32-bit processor.

Key Exchange: This is where most of the CPU bottleneck on SSL servers occurs. SSL has been optimized to require a minimum amount of RSA operations to set up a secure session. Avoid temporary RSA keys which can cause a massive performance hit.

Netscape has published figures suggesting that the throughput (in hits per second) of an SSL-enabled server is as low as 20 percent of that of an unencrypted server. The greatest performance hit occurs when the server and client exchange handshake

messages for authentication and key generation/exchange. These operations are performing computationally intensive public key operations. Subsequent hits use the session restart feature of SSL. This enables the server and client to simply use the previously negotiated secret key.

Web Browser Attacks

Web browser attacks are pretty typical of Web-based applications in general. The attacks can be summarized as follows:

- ♦ **Hijacking**— This is a man-in-the-middle attack in which the attacker takes over the session.
- ♦ **Replay**— This is a man-in-the-middle attack in which sent data is repeated (replayed) leading to various results.
- ♦ **Spread of malware (viruses, worms, and so on)**— The scripting nature of Web browsers makes them prime targets for the spread of malware.
- ♦ **Running dangerous executables on the host**— In some cases, the browser may permit executables to run on the host workstation. This can be very risky.
- ♦ **Accessing host files**— Certain attacks allow the browser to send files to an attacker. These files may contain personal information, such as banking data, or system information, such as passwords.
- ♦ **Theft of private information**— Browsers are at risk of disclosing sensitive information to strangers on the Internet. This information may be used in identity theft or to conduct a social engineering attack.

Hijacking attack

Session hijacking occurs when an HTTP session is observed and captured by a network sniffer. The attacker modifies the captured traffic to allow the attacker to take the place of the client. All future traffic in the session is now channeled between the Web server and the attacker.

The hijacking is usually done after the legitimate user has authenticated to the Web server. Therefore, the attacker does not have to re-authenticate (usually for the remainder of the session). In this way, the attacker bypasses one of the major security features of the Web-based session, the initial authentication.

The hijacking attack exploits a weak method of maintaining state. If the attacker can understand how state is maintained, they may be able to inject themselves into the middle of the session by presenting a valid state.

One typically weak method of maintaining state is using cookie data to maintain state. In this method, the user is initially authenticated (usually with a user id and password). If the authentication is successful, the Web server sends a session cookie to the user's browser. Now every time the browser hits that same web server (presumably during the same session), the user does not need to enter the password, rather the cookie re-authenticates for the user. Figure 6-3 illustrates a hijacking attempt to exploit this weak method of maintaining state.

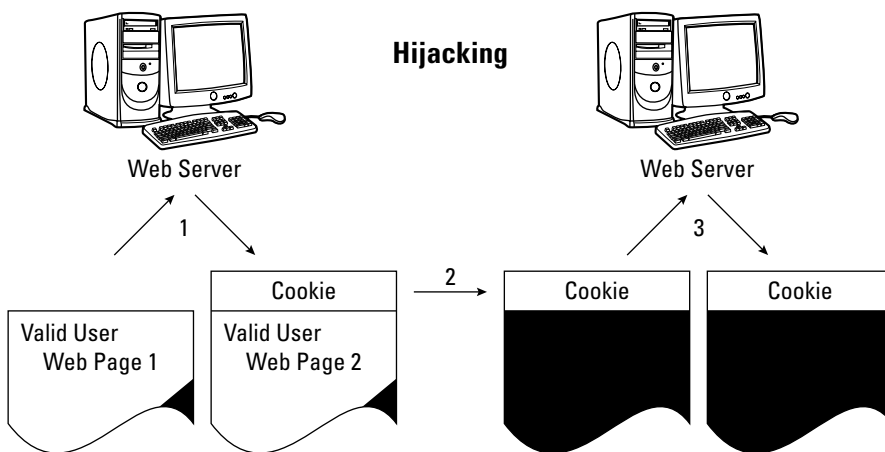

1. A valid user does some web activity that results in their acquiring a Cookie.
2. The Cookie is stolen or captured by an attacker.
3. The Cookie is transmitted with the attacker's attempt to access the application. The Cookie authenticates the attacker as a valid user. The attacker gets access to the application.

Figure 6-3: Hijacking when cookies maintain state

Replay attack

Session replay occurs when an HTTP session is captured by a network sniffer. Some aspect of the session is then modified (certain replays, such as transferring bank funds, may not require modifications). The modified session is then fed back onto the network. If the replay is successful, the Web server will believe the replayed traffic to be legitimate and respond accordingly. This could produce a number of undesirable results. Figure 6-4 illustrates session replay.

The responsibility is on the Web server to prevent replay attacks. A good method for maintaining the session will also prevent a replay attack. The Web server should be able to recognize replayed traffic as no longer being valid.

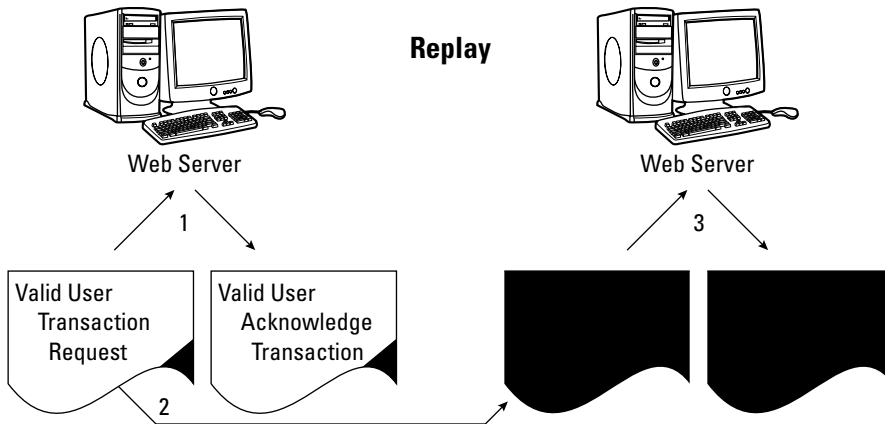

1. A valid user does some web activity such as "Transfer \$5,000 from account A to account B". There may or may not be a cookie.
2. The web page holding the transaction request is stolen or captured by an attacker.
3. The web page is re-transmitted. The transaction is repeated - an additional \$5,000 is transferred. The attacker can re-transmit numerous times.
4. Depending on whether the attacker had to do spoofing, the final acknowledgment transaction may go back to the valid user's IP address where it is dropped because no session is open.

Figure 6-4: Relay attack

Browser parasites

A browser parasite is a program that changes some settings in your browser. The parasite can have many effects on the browser, such as the following:

- ♦ Browser plugin parasites may add a button or link add-on to the user's browser. When the user clicks the button or the link, information about the user is sent to the plugin's owner. This can be a privacy concern.
- ♦ Browser parasites may change a user's start page or search page. The new page may be a "pay-per-click site," where the owner of the browser parasite earns money for every click.
- ♦ Browser parasites may transmit the names of the sites the user visits to the owner of the parasites. This can be used to formulate a more directed attack on the user.

A typical browser parasite is the W97M_SPY.A. Once installed, this parasite hides from the user and stays resident in the background. This spyware macro program originated in France. It steals e-mails and addresses from the user's contact list and

then sends the information to a hacker's e-mail address. The W97M_SPY.A can be manually removed by editing the Registry for the key:

```
HKEY_LOCAL_MACHINE\Software\Microsoft\Windows\CurrentVersion\Run
```

Then delete the key value:

```
Spy='%winsysdir%\Spy.vbs'
```

Finally, the user needs to find and delete the files W97M_SPY.A and VBS_SPY.A.

Operating Safely

Learning to operate a Web browser safely is a tall order with all the attacks that are possible today. Even if users manage to configure their browsers for the safest possible operation, they are still at risk in how they navigate the Internet and how they respond to certain circumstances.

For example, the most secure browser settings won't improve your security unless you respond appropriately to any prompt dialog boxes that come up. If the prompt asks if an ActiveX control should be run, the user must decide to completely trust the site and click OK. If the user chooses poorly, a dangerous ActiveX application can bypass all the security features and run on the user's host workstation.

If users do configure their browsers for strong security, they will experience the brunt of the security versus convenience dilemma. The user will be constantly barraged with requests to accept cookies, scripts, and other features such as ActiveX. Under this constant barrage, the typical user will give in and loosen the security settings.

Users can take a number of steps to increase the security of their web browser. Users should evaluate the risks based on their own circumstances and decide which steps are appropriate for them. These steps include the following:

- ♦ Keeping current with patches
- ♦ Avoiding viruses
- ♦ Using secure sites for financial and sensitive transactions
- ♦ Using a secure proxy
- ♦ Securing the network environment
- ♦ Avoiding using private information
- ♦ Taking care when changing browser settings

Keeping current with patches

The Web browser is one of the favorite targets for hackers trying to find security flaws. There is far too much activity regarding Web browser security for the typical user to keep on top of the issues. Users must, therefore, rely on vendors such as Netscape and Microsoft to keep up with the security vulnerabilities of their products. These vendors must then make updates and patches available to users in a timely manner.

Regular updates and patches are available for high visibility Web tools such as the Web browser. These updates will include patches to recently found security flaws. Users should check for updates and patches on a regular basis.

For example, the Internet Explorer High Encryption Pack provides 128-bit encryption, the highest level of protection Microsoft can offer for Internet communications, including credit card use and financial transactions.

Avoiding viruses

Many of the worms and viruses today will attack the Web browser because of its ability to propagate malware. To maintain the overall security of the Web browser, it is important for the user to maintain a virus-scanning program running on the workstation.

As with all security tools, it is important that the virus protection software be kept up to date with patches and updates.

Using secure sites

SSL adds significant advantages to securing Web browser transactions and data (as discussed earlier in this chapter). These added benefits make SSL a must for any Web sites using sensitive, private, or financial data.

There should be no acceptable excuses for not using SSL. All major browsers support SSL. On the server side, SSL is more expensive and only slightly more difficult to implement and maintain. Any security-conscious software development organization will invest in the SSL capability to provide the added protection to the users of their product.

An alarm should go off in the head of any user asked to enter any of the following data in a Web site not running SSL:

- ♦ Social Security Number (SSN)
- ♦ Addresses, including home, business, and shipping addresses

- ♦ Phone numbers, including home, business, cell, and fax
- ♦ Credit card information
- ♦ Personal identification numbers (PINs)
- ♦ Financial data — this can include banking account numbers
- ♦ Secondary identification information, such as mother's maiden name, high school, favorite pet, and so on

Attackers can use the information listed in the preceding list to steal a person's identity. Identity theft is a far too common occurrence. As the world's economy moves more and more to doing business on the Internet, it is expected that identity theft will become more of a risk.

A user may have faith or trust in an organization when dealing with them face to face, such as a local branch office of a bank, but this trust should not be extended automatically to any online capability that the organization offers. A personal trust of the organization is not sufficient reason to provide them personal financial information if they don't handle it correctly. Following are some aspects of the security risk to keep in mind:

- ♦ As an individual, you may not be a target. But as an Internet-based organization, the site you are dealing with is a big target, particularly if it is gathering personal or financial data on you.
- ♦ The Web site can be attacked at an organization's database. This risk is only slightly reduced with the use of SSL, but if the organization cares enough to use SSL, they are probably taking steps to improve their database security.
- ♦ The Web site can be attacked as the data transits to (and from) the Web site. There are probably a few hops between the user and the Web site. At each hop along the way, there may be a dozen persons with administrator or root access to the routers and gateways. That all adds up to a large number of people to trust. SSL virtually protects the user's sensitive data from all these administrators.
- ♦ The Web site (or organization behind it) can be attacked in an organization's local network. Organizations often overlook the insider threat. The use of SSL will protect the data during transmission even against a local network administrator.
- ♦ The Web site (or organization behind it) can be attacked with social engineering. The social engineering attack could yield access to many resources in the organization. The use of SSL will protect against an attacker gaining access to the local network.

When using a Web site secured with SSL, the Web browser will provide a visual indicator that the site is secure. With Internet Explorer a little closed padlock will be displayed in the lower right-hand corner of the browser window. With Netscape, a padlock can be seen in the lower left-hand corner of the browser.

The level of encryption can be determined on Internet Explorer by clicking the Help menu and then selecting About Internet Explorer. This will show the version of the browser and the level of security. In Netscape, if the key has one large tooth, it means that you have 40-bit encryption software. If the key has two large teeth, it means you're using 128-bit encryption. If the browser is not using 128-bit encryption, it should be upgraded immediately.

Securing the network environment

The most securely developed application is still vulnerable if placed in an insecure environment. Therefore, it is important to have the security of the environment match the sensitivity and criticality of the application.

By way of an example, the following are the Visa requirements for an application or system that processes their cards. The detailed description of the Visa Card Holder Information Security Program (CISP) can be found at http://usa.visa.com/business/merchants/cisp_index.html. The program has these recommendations:

- ♦ Install and maintain a working firewall to protect data.
- ♦ Keep security patches up-to-date.
- ♦ Protect stored data.
- ♦ Encrypt data sent across public networks.
- ♦ Use and regularly update antivirus software.
- ♦ Restrict access on a need-to-know basis.
- ♦ Assign a unique ID to each person with computer access.
- ♦ Don't use vendor-supplied defaults for passwords and security parameters.
- ♦ Track all access to data by unique ID.
- ♦ Regularly test security systems and processes.
- ♦ Implement and maintain an information security policy.
- ♦ Restrict physical access to data.

Using a secure proxy

A proxy server provides a secure gateway for one (or more) protocols. All Web-browsing traffic destined for the Internet must pass through the Web proxy. The use of a secure Web proxy provides a number of advantages, as follows:

- ♦ **Some of the security features may be moved from the browser to the Web proxy.** It is often easier for a network administrator to manage a proxy than to manage hundreds of individual browsers.
- ♦ **The security features of the proxy will work for all versions of browsers.** All browsers support the use of a Web proxy. Suppose the security administrator wants to implement a security control such as blocking all ActiveX. It is easier to do it on a single proxy as compared to determining how to implement this control on every different version of browsers on the network.
- ♦ **The proxy may improve Web-browsing performance by caching frequently used sites.** There is usually a sufficient increase in performance to make up for the extra processing needed to browse through the proxy.
- ♦ **Proxies can be particularly useful with children to restrict sites and prevent the leakage of private data.** This is a big concern when considering the welfare of children.

Avoid using private data

Anytime sensitive or private information is put on a system that is outside the user's complete control, there is a risk of that data being compromised. A lot goes into having a secure Web site that can protect the user's personal information. For example, the Web site organization must do the following:

- ♦ Develop a safe web-based application.
- ♦ Properly configure and maintain database security.
- ♦ Harden the web server's host.
- ♦ Secure the network on which the Web server resides.
- ♦ Establish policies and procedures for handling sensitive data.
- ♦ Hire responsible people and provide them adequate training.

Obviously all of these steps are out of the control of Web browser users, who want to be assured that their private data is handled safely.

For example, the Web site may not protect the logs for the Web server, leaving the logs open for casual viewing by anyone with access to the network. The GET requests will appear in the server log files. Depending on the Web site, sensitive information may be passed on the GET line. It should be noted that POST requests do not get logged.

The best defense for the user is to avoid using sensitive and private data whenever possible.

General recommendations

The following are recommendations to improve the Web browser security or reduce the security risk while browsing on the Internet.

- ♦ **Be careful when changing browser configurations.** Do not configure a command line shell, interpreter, macro processor, or scripting language processor as the “viewer” for a document. This shifts control to the creator of the file. The type of a document is determined by the Web server, not the browser. Do not declare an external viewer for any file that contains executable statements.
- ♦ **Don’t configure to support scripts and macros.** Do not configure an external view to be any application that supports scripts and macros, such as Excel and Word.
- ♦ **Never blindly execute any program you download from the Internet.** When possible, download scripts as text and examine the code before running the script.
- ♦ **Browse to safe places.** A user’s risk of getting malcode and parasites can be greatly reduced by avoiding hacker and underground sites.
- ♦ **Be conscious of the home page configuration.** Every time you bring up the browser, which for most people is every time they start their machine, some Web sites will know it. The tracking of users in this manner is low risk. Consider setting the home page to be blank.
- ♦ **Don’t trust links.** Be suspicious of everything. Get into the habit of reading where the link is before you blindly click.
- ♦ **Don’t follow links in e-mail.** E-mail is easily spoofed, meaning the mail may not be coming from the person on the From: line. A legitimate business, such as your bank, will not send an e-mail to its clients and ask them to click to log in.
- ♦ **Avoid browsing from systems with sensitive data.** If possible, use a less risky workstation to browse the Internet. This less risky workstation should not have sensitive and private data on it.
- ♦ **Guard your information.** If possible, don’t use personal information on the Web.
- ♦ **Use stronger encryption.** Choose 128-bit encryption over 56 or 40 bit.

- ♦ **Use a less common browser.** Because most hackers are trying to exploit Netscape and Internet Explorer, some security can be gained by using another browser.
- ♦ **Minimize use of plugins.** JavaScript, Java, and ActiveX all have vulnerabilities and should be avoided, if possible.
- ♦ **Minimize use of cookies.** Private or sensitive data might be extracted from a Web browser through cookies.
- ♦ **Be conscious of where temporary files are stored and how they are handled.** These temporary files may hold private and sensitive information. Make sure the files are not on a shared directory. If possible, set the browser to clear the history of saved files and locations visited to zero or one day. Learning about a user's Web-browsing habits can be a valuable aid in conducting a social engineering attack.

Web Browser Configurations

In addition to operating a Web browser safely, configuration items can make Web browsing more secure. The configuration items concern the use of cookies and plugins. Additionally, each vendor has some browser-specific configuration issues.

Cookies

Cookies are small text files that are sent to web browsers by Web servers. A cookie's main purpose is to identify users and to present customized information based on personal preferences. Cookie files typically contain information such as your user name, password information, or ad-tracking information.

Because cookies are simple text files, they cannot contain viruses or execute applications, they cannot search your hard drive for information, or send it to Web servers. Most of the information in a cookie is simple tracking information designed to provide enhanced customer convenience.

Cookies are generally not a security threat. However, they can pose a privacy concern. Any information that a user has ever entered into a browser may be stored in a cookie. All of that information may then be shared with every Web site the user visits. Clearly, this is an exaggerated worst-case scenario. A good browser will provide some control over cookies to greatly mitigate this risk.

Cookies cannot be used to search the workstation for sensitive information. Rather, they can only store information that the user has previously provided to a Web site. One of the best ways to avoid the loss of privacy through cookies is to not put private and sensitive data into the browser in the first place.

Some configuration items that can be set on the Web browser to mitigate the risk of a loss of privacy due to cookies are as follows:

- ♦ **Turn off all cookies.** Very few Web sites will fail if cookies are disabled completely. Some conveniences will be lost, such as keeping a shopping cart while the user continues to shop on the Web site. Also, some banking sites may not operate without cookies. If the user has disabled all cookies and encounters the need for them on certain sites, cookies can be enabled just for those sites. The difficulty is being able to recognize that the site is not functioning properly because cookies are disabled. In some cases, when a site is dependent on cookies to function, the site may attempt to send the cookie over and over again. In this circumstance the user must weigh the privacy risk with the convenience of using that particular site.
- ♦ **Limit the Web sites that can set cookies.** The browser can be set to ask the user if any particular cookie should be accepted. In this way, the user can decide in each case if the information put into the browser for that particular site poses a privacy risk. In most cases, when prompted to accept or reject a cookie, the user has an option to accept all future cookies from this web site.
- ♦ **Only return cookies to the originating domain.** Cookies originate (are sent to the browser) from a Web server. The browser can refuse to send these cookies back to any Web site other than the one that created the cookie in the first place. This will mitigate the risk of a third-party site trying to get private data on a user.
- ♦ **Force all cookies to be nonpersistent.** Nonpersistent cookies are deleted after they are no longer needed. In some cases, this is when the browser is closed. It would be very unusual for a web site to require a persistent cookie on the user's browser. Many Web sites do use persistent cookies as a matter of convenience for the user, but the sites perform just as well without the cookies being persistent.
- ♦ **Clean out persistent cookies.** Periodically, go into the browser settings and delete any persistent cookies.

Plugins

Java, JavaScript, and ActiveX controls are used by many Web sites to make Web browsing convenient and powerful. However, with added convenience comes a greater security risk. Java and ActiveX are executable code that you download and run on your local computer. JavaScript is a scripting language that is downloaded and executed.

ActiveX is more dangerous than Java or JavaScript. ActiveX can make system calls that can affect the files on your hard drive. With ActiveX controls, new files can be created or existing files can be overwritten. There are many files that control the workstation that should not be alterable by some stranger on the Internet.

Many users are not aware of the differences between Java and JavaScript. Java is a language designed by Sun Microsystems which results in executable code. Java code is compiled into applications known as Java applets. Browsers that support Java applets will download the compiled Java applications and execute them.

JavaScript (or Jscript) is a series of extensions to the HTML language designed by the Netscape Corporation. JavaScript is an interpreted language that executes commands on behalf of the browser. The scripts have the ability to open and close windows, manipulate form elements, adjust browser settings, and download and execute Java applets.

ActiveX

ActiveX is a technology developed by Microsoft Corporation for distributing software over the Internet. ActiveX controls are available for Internet Explorer.

ActiveX controls are distributed as executable binaries and are compiled for each target machine and operating system.

The use of ActiveX is a security risk because the browser places no restrictions on what an ActiveX control can do.

To mitigate the risk of using ActiveX plugins, each control can be digitally signed. The digital signatures can then be certified by a trusted certifying authority, such as VeriSign. The user does not know if the ActiveX code is safe to execute; rather, the user is assured of who is providing the code. In the end, the user is allowing the signing organization to do anything they want on the user's workstation and trusting that the organization will act responsibly.

If the browser encounters an ActiveX control that hasn't been signed (or that has been signed but certified by an unknown certifying authority), the browser presents a dialog box warning the user that this action may not be safe. At this point the user can elect to accept the control or cancel the download. If the user accepts the ActiveX control they are putting their entire workstation at risk. Few users that accept an unsigned control appreciate the risk involved. Digital signatures on ActiveX controls are of little protection to an unsophisticated user.

The following steps will disable ActiveX controls on Internet Explorer:

1. From the menu bar select View ⇄ Internet Options.
2. In the pop-up window, select the Security tab.
3. In the pull-down list of options, select Internet Zone.
4. Select the Custom security level check box.
5. Click the Settings button.

6. Scroll down to the ActiveX and Plug-ins section. Select Disable.
7. Click the OK button to close out of the window.
8. Click the OK button to close out of the options window.

Java

Java applets are programs written in the Java programming language that are run on the user's workstation. The Java applets are commonly used as a user interface to server-side programs.

Java has a large number of security safeguards intended to avoid attacks. However, anytime code written by a stranger is run on the user's workstation, care should be taken. Disabling Java is a recommended option for a security-conscious user.

Several security features were built into Java to prevent it from compromising the remote user's machine. When running as applets, Java scripts are restricted with respect to what they are allowed to do by a security manager object. The following security features are part of the Java design:

- ♦ The security manager does not ordinarily allow applets to execute arbitrary system commands, to load system libraries, or to open up system device drivers such as disk drives.
- ♦ Scripts are generally limited to reading and writing to files in a user-designated directory.
- ♦ Applets are also limited in the network connections they can make: An applet is only allowed to make a network connection back to the server from which it was downloaded. This security hole involves Java's trusting use of the Domain Name System (DNS) to confirm that it is allowed to contact a particular host. A malfasant using his own DNS server can create a bogus DNS entry to fool the Java system into thinking that a script is allowed to talk to a host that it is not authorized to contact.
- ♦ The security manager allows Java applets to read and write to the network and to read and write to the local disk but not to both. This limitation was created to reduce the risk of an applet spying on the user's private documents and transmitting the information back to the server.

To disable Java applets in Netscape, follow these steps:

1. From the menu bar select Edit ⇄ Preferences.
2. Select the Advanced tab from the options at the left.
3. Deselect the check box Enable Java.
4. Click the OK button at the bottom of the dialog window.

To disable Java Applets in Internet Explorer, follow these steps:

1. From the menu bar select Tools ⇨ Internet Options.
2. In the pop-up window, select the Security tab.
3. In the pull-down list of options, select Internet Zone.
4. Below, select the Custom security level check box.
5. Click the Settings button. A scrolling list will pop up.
6. Scroll down until you see the Java item. Select Disable Java.
7. Click the OK button at the bottom of the Settings.
8. Click the OK button at the bottom of the dialog window.

JavaScript

The designers of JavaScript built security into the language itself. The basic approach was to eliminate the possibility of JavaScript code doing insecure activities by not providing commands or objects for those activities. Some examples of the security issues with JavaScript are as follows:

- ♦ **JavaScript cannot open, read, write, create, or delete files.** The language does not have any objects for managing files. A script cannot even list files and directories.
- ♦ **JavaScript cannot access the network or network resources.** The language does not have any objects for connecting or listening to the network interface.
- ♦ **JavaScript can access information available to the browser.** Information such as URL's, cookies, names of files downloaded, and so on.
- ♦ **JavaScript can only access the domain from which it was downloaded.** The script cannot access any other domain other than the one from which it originated.
- ♦ **JavaScript can make HTTP requests.** Scripts can request URLs and send other HTML information such as forms. This means the scripts could hit CGI programs that run on the Web server.

Over the years, JavaScript has produced quite a few security vulnerabilities for Web browsers. Patches and updated browsers have eliminated most of the security problems. However, the general concept that JavaScript is a potential avenue for the loss of private data still exists. Therefore, the general recommendation is to disable JavaScript unless it is explicitly needed for a trusted Web site.

The following steps are for disabling JavaScript on the Netscape browser:

1. From the menu bar select Edit ⇨ Preferences.
2. In the pop-up window, select the Advanced tab from the options on the left.

3. Deselect the check box Enable JavaScript.
4. Deselect the check box Enable JavaScript for Mail and News.
5. Click the OK button at the bottom of the dialog window.

The following steps are for disabling JavaScript on Internet Explorer:

1. From the menu bar select Tools ⇨ Internet Options.
2. In the pop-up window, select the Security tab from the top.
3. In the pull-down list of options, select Internet Zone.
4. Below, select the Custom security level check box.
5. Click the Settings button. A scrolling list will pop up.
6. Scroll down until you see the Scripting item. Under Active Scripting, select Disable and Disable Scripting of Java Applets.
7. Click the OK button at the bottom of the Settings.
8. Click the OK button at the bottom of the dialog window.

Netscape-specific issues

Even though Netscape and Internet Explorer both manage the client end of the HTTP protocol, they do differ in how the features and configurations are handled.

Encryption

Netscape browsers use either a 40-bit secret key or a 128-bit secret key for encryption. The 40-bit key was shown to be vulnerable to a brute force attack. The attack consisted of trying each of the 2^{40} possible keys until the one that decrypts the message was found. This was done in 1995 when a French researcher used a network of workstations to crack a 40-bit encrypted message in a little over a week.

The 128-bit key eliminates the problem of a brute force attack because there are 2^{128} possible keys instead of 2^{40} . To crack a message encrypted with such a key by brute force would take significantly longer than the age of the universe using conventional technology.

Netscape cookies

Setting up cookies in Netscape is different from doing so in Internet Explorer:

1. Select Edit from the Netscape menu and then choose Preferences.
2. In the Preferences window, select Advance.

3. In the section dedicated to cookies, choose the appropriate setting—your options are:
 - Only accept cookies originating from the same server as the page being viewed
 - Do not accept or send cookies

History and cache

The browser stores the URLs of the sites visited as a convenience for the users. Taken as a whole, this can represent a pattern of usage that many users would consider private and sensitive. It is recommended that the history settings be minimized. Also, the history data should be cleared periodically.

In Netscape, you can specify when the history list expires and manually clear the history list. This can be done with the following steps:

1. Select Preferences from the Edit menu.
2. Choose Navigator from the left frame.
3. Specify when pages in the history list expire by entering the number of days.
4. Clear the history list by clicking the Clear History button.

Browsers use two types of cache: memory cache and disk cache. Both caches should be cleared to ensure that no one can view information that you have accessed while using the browser.

In Netscape, the following steps will clear the cache:

1. Select Preferences from the Edit menu.
2. Choose Advance from the left frame and expand the list.
3. Click Cache.
4. Click to clear Memory Cache.
5. Click to clear Disk Cache.

Internet Explorer–specific issues

Internet Explorer is a powerful and feature-rich tool for browsing the Internet. There are many configuration items available to make Internet Explore more secure. The Internet Explore configuration options are accessed by selecting the Tools ⇄ Internet Options from the menu.

General settings

The general settings control the home page, temporary Internet files, and the history list of visited Web sites.

Users should set their home page to Blank to prevent any Web site from tracking the behavior of the user. However, setting the home page to a favorite search engine, such as Google or Yahoo, should be considered low risk.

With regard to the history, cookies, and temporary Internet files, it is advisable to periodically delete this stored information. These files and cookies can profile a user and contain sensitive or private information.

Security settings

Internet Explorer orients the Security settings around the Web content zone of the site to be accessed by the Web browser. In other words, the security settings the browser uses will depend on which zone the Web site being requested resides in. The zones are as follows:

- ♦ Internet
- ♦ Local intranet
- ♦ Trusted sites
- ♦ Restricted sites

Internet

This zone contains all Web sites the user hasn't placed in any other zone. In a sense, this is the default zone. Unless security is relaxed for a particular site, it will be put into the Internet zone and have default security settings.

This is one zone to which you cannot add sites. By default, all Web sites that are not added to the Local intranet zone, the Trusted Sites zone or the Restricted Sites zone, are placed into the Internet zone.

The default security setting for the Internet sites zone is Medium, which entails the following:

- ♦ ActiveX requires user acceptance before running.
- ♦ Unsigned ActiveX controls cannot be downloaded.
- ♦ Scripts and Java applets are enabled.
- ♦ Files can be downloaded, but prompt before downloading potentially unsafe content.
- ♦ The user is prompted before the installation of desktop items.

Local intranet

This zone is intended to contain all Web sites that are on the user's organization's intranet. These sites are considered to be more trusted than those that default on the Internet zone.

The Local intranet zone contains local domain names, as well as the addresses of any proxy server exceptions you may have configured. To be effective, the Local intranet zone should be set up in conjunction with a local area network (LAN) proxy server or firewall. The intent is that all sites in the Local intranet zone are on the local network and inside the firewall.

The default setting for this zone is Medium-low, which provides the following security:

- ♦ Most content will be run without prompts.
- ♦ ActiveX requires user acceptance before running.
- ♦ Unsigned ActiveX controls cannot be downloaded.
- ♦ Scripts and Java are enabled.
- ♦ The user is prompted before the installation of desktop items. This controls whether or not the user can download and install Active Desktop content.

Trusted sites

This zone contains Web sites that the user trusts will not damage the workstation. The user should also trust this site with sensitive or personal data. The Security settings can require SSL for all the sites in this zone.

The Trusted sites zone includes sites that will not damage the workstation. It is very difficult to trust any site that is outside an individual's direct control. This trust may extend to organizational resources that are under the watchful eyes of network security engineers.

This zone should rarely be used. Few Web sites need the added features of this zone. Most Web sites that might be put in this zone will probably operate equally well in the Local intranet zone.

The default security level for the Trusted sites zone is Low and has the following settings.

- ♦ Minimal safeguards and prompts are provided.
- ♦ Most content is downloaded and run without prompts.
- ♦ All scripts, Java, and ActiveX content can run.

Clearly, given these settings, this zone is only appropriate for Web sites that are absolutely trusted.

Restricted sites

This zone contains Web sites that could potentially damage your computer or data.

The default security level for the Restricted sites zone is High and has the following settings:

- ◆ All scripting, Java, and ActiveX is disabled.
- ◆ Files cannot be downloaded.
- ◆ Prompting is required before downloading fonts.
- ◆ Data sources cannot be accessed across domains. This controls cross-domain data access, which can open the door to various spoofing attacks.
- ◆ Installation of desktop items is disabled.

Privacy settings

Internet Explorer allows the user to set one of six levels of privacy. These settings, for the most part, adjust how the browser will deal with cookies. The six possible settings are as follows:

- ◆ **Accept All Cookies**—All cookies will be saved on the user's workstation and existing cookies can be read by the Web sites that created them.
- ◆ **Low**—Third-party cookies that contain sensitive or personal information will require the user's permission to be used. Also, third-party cookies that do not have a compact privacy policy are restricted.
- ◆ **Medium**—First-party cookies that contain sensitive or personal information will require the user's permission to be used. Third-party cookies that contain sensitive or personal information will be blocked completely. Also, third-party cookies that do not have a compact privacy policy are now blocked.
- ◆ **Medium High**—The settings are the same as Medium, except that now first-party cookies that contain sensitive or personal information will be blocked completely.
- ◆ **High**—All cookies containing personal data require the user's explicit permission to be used. Also, all cookies that do not have a compact privacy policy are completely blocked.
- ◆ **Block All Cookies**—All new cookies will be blocked and existing cookies cannot be used.

**Note**

First-party cookies are returned to the Web site that created them in the first place. Third-party cookies are sent to a Web site that did not create the cookie.

The Privacy settings tab also allows the user to override cookie handling for individual Web sites. The user can specify which Web sites are always (or never) allowed to use cookies, regardless of the site's privacy policy. The user must enter the exact address of the Web site to allow or block cookies.

Content settings

The Content settings deal with the Content Advisor, Certificates, and Personal information.

The Content Advisor uses a rating system to help the user control the Internet content that can be viewed on the browser. When enabled, the user can choose to control four categories, as follows. Each category has five settings from mild to strong.

- ♦ **Language** — controls slang and profanity
- ♦ **Nudity** — controls levels of attire and nudity
- ♦ **Sexual** — controls sexual activity (kissing and so on)
- ♦ **Violence** — controls aggressiveness of the violence

The Content Advisor allows the user to set Approved Sites that are always viewable (or never viewable), regardless of how they are rated. Also, the rating system can be changed. When the user leaves the Content Advisor enabling windows, they are prompted to enter a password for controlling further changes to the Content Advisor.

The Content settings allow users to view, add, and delete certificates. Additionally, the user can add or delete certificate authorities that will validate certificates received by the browser.

The Personal information settings allow the user to enter personal profile information. This is done by creating a new entry in the Address Book. Typical information in the profile would include name, e-mail, home and business addresses, spouse and children's names, birth date, and a digital ID. It is recommended that such personal information not be stored with the browser or be made browser accessible.

Advanced settings

Internet Explorer has quite a few advanced settings. The following list shows some of the settings relevant to security. These settings are recommended, unless otherwise noted:

- ♦ Notification about script errors can be disabled. This is not recommended because script errors may be an indication of an attack.
- ♦ Java 2 to be used for Java applets.
- ♦ Enable or disable Java console, Java logging, and use of the JIT compiler for virtual machine.
- ♦ Check for publisher's certificate revocation.
- ♦ Check for server certificate revocation.
- ♦ Check for signatures on downloaded programs.

- ♦ Save encrypted pages to disk.
- ♦ Empty temporary Internet files when browser is closed.
- ♦ Enable integrated windows authentication.
- ♦ Enable profile assistant. This is not recommended because personal information may be disclosed.
- ♦ Use SSL 2.0, SSL 3.0, and TLS 1.0.
- ♦ Warn about invalid site certificates.
- ♦ Warn if changing between secure and not secure mode.
- ♦ Warn if forms submittal is being redirected.

Encryption

It is recommended that 128-bit encryption be used in Internet Explorer. When using SSL, a solid padlock will appear on the bottom right of the screen. To determine whether 40-bit or 128-bit encryption is in effect, select Properties from the File menu. This opens the document information page and will indicate whether weak (40-bit) or strong (128-bit) encryption is in use.

Summary

For many nontechnical people, the power and usefulness of the Internet is personified in their Web browsers. Web browsing is by far the most popular use of the Internet. The combination of being very convenient and popular makes the Web browser a favorite target for viruses and other attacks. Some of the key steps that can be taken to allow for safe browsing on the Internet are as follows:

- ♦ Keep current with Web browser patches.
- ♦ Use antivirus software.
- ♦ Use secure sites for financial and sensitive transactions.
- ♦ Secure the network environment.
- ♦ Avoid using private information while browsing.
- ♦ Take care when changing browser settings.



Web Security

Around the year 2000, the language of the Internet transitioned from File Transfer Protocol (FTP) to Hypertext Transfer Protocol (HTTP). This marked the broad acceptance of the World Wide Web. Web sites are accessed by engineers, businessmen, clerks, teachers, students, parents, grandparents, children, and everyone in between, and security is a significant element of every one of these transactions. Even activities as simple as checking the local weather or shopping online for a gift can be the target of a malicious attack.

This chapter discusses network security as it is applied to the World Wide Web, in particular, communication that takes place over HTTP. Details of not only how the protocol works but why and the associated security issues are described. In conclusion, it describes a method for implementing a secure e-commerce site.

What Is HTTP?

HTTP is a generic communication protocol used to transfer requests, responses, and data between Web clients and servers. Data transfer can be in the form of plain text, formatted text, or encoded binary.

Although not as common, this extensible protocol is occasionally used by clients accessing proxies and gateways that communicate to servers in other protocols. These gateways provide the ability for HTTP to communicate with the following:

- ◆ Simple Mail Transfer Protocol (SMTP)
- ◆ Network News Transfer Protocol (NNTP)
- ◆ File Transfer Protocol (FTP)
- ◆ Post Office Protocol (POP)
- ◆ Wide Area Information Servers (WAIS)
- ◆ Gopher servers

7 CHAPTER



In This Chapter

Understanding HTTP

Identifying common Web security weaknesses and attacks

Developing secure Web sites

Understanding tracking mechanisms

Building an e-commerce design



HTTP rests on top of the layer 4 Transmission Control Protocol (TCP) transport protocol. Each HTTP session initiates with the TCP three-way handshake and is terminated with an acknowledged FIN packet. Most HTTP traffic takes place across TCP port 80.

HTTP has a range of commands, or methods, it can use. Although by design it is capable of much more, security concerns and lack of necessity have reduced HTTP to a small handful of common methods. These methods, their purpose, and syntax are described in the following list:

- ♦ **GET**—A request from the client to retrieve an object from the server. It has the following syntax:

```
GET Request-URI Version
```

An example follows:

```
GET / HTTP/1.1
```

`Request-URI` is the object of interest on the Web server. When viewing a Web site's root directory (for example, `www.yahoo.com` versus `www.yahoo.com/travel`), the URI is simply `/`. Although not a requirement, Web clients generally include the maximum version of HTTP that they support. This ensures that both the client and server communicate using the same feature set. The option not to include the version is referred to as a *simple request* and is provided for backward compatibility with HTTP/0.9. The response to this request from a Web server is in the form of a status number (200, if successful), and the content of the requested object.

- ♦ **HEAD**—A request from the client to retrieve meta-information about an object from the server. It has the following syntax:

```
HEAD Request-URI Version
```

An example follows:

```
HEAD / HTTP/1.1
```

The only difference between a GET and a HEAD response is that the HEAD does not actually return the body of the `Request-URI`. It is used to find out meta-information about the server and verify the status and existence of an object prior to receiving it. For example, it can be particularly useful to determine if a site has changed from its last viewing without retrieving it. All other header fields within the response exist and are identical.

- ♦ **POST**—A request from the client to send an object to a handler on the server. It has the following syntax:

```
POST Request-URI Version
```

An example follows:

```
POST /cgi-bin/message.cgi HTTP/1.1
```

`Request-URI` is the Web page intended to receive the posted data. POST is commonly used in forms to submit a message to a bulletin board, newsgroup,

Web-based e-mail, or to send data for handling by a database or active content script.

- ♦ **PUT**—A request from a client to send an object and place it directly on the server. It has the following syntax:

```
PUT Request-URI Version
```

An example follows:

```
PUT /home/mypage.html HTTP/1.1
```

Request-URI is the location that the client would like the data placed at on the server. PUT is occasionally used to provide authorized users with a means of uploading content directly to a Web site. Additional security precautions must be taken with servers that are configured to accept this method.

- ♦ **DELETE**—A request from a client to delete an object from the server. It has the following syntax:

```
DELETE Request-URI Version
```

An example follows:

```
DELETE /home/invitation.html HTTP/1.1
```

Request-URI is the location of the object that the client would like to delete from the server. Similar to PUT, DELETE is generally not supported by most Web servers. It is dangerous to provide outside users with the ability to modify content on a Web site.

How Does HTTP Work?

HTTP operates through a simple request and response model. The client, or Web browser, initiates a session by issuing a request method and a request object (that is, Request-URI). The Web server processes and handles this request and the appropriate response is returned to the client.

Figure 7-1 shows the basic request and response model used in an HTTP session. Figure 7-2 provides examples of successful and unsuccessful HTTP requests from an Apache Web server log file.

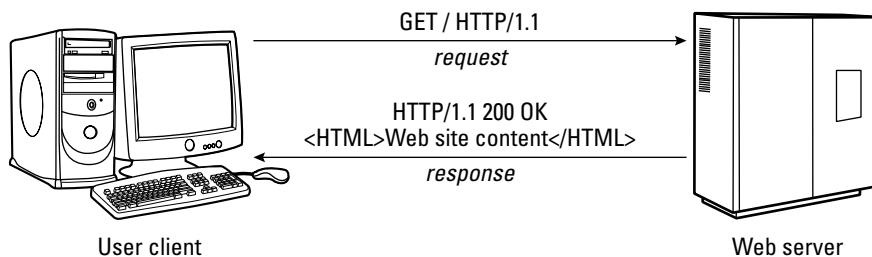

Figure 7-1: The basic request and response model used in an HTTP session

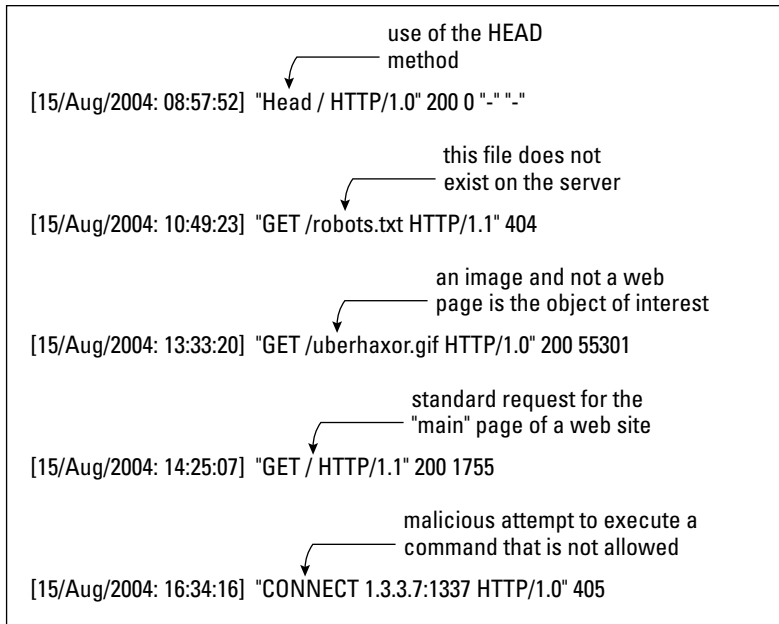

Figure 7-2: Examples of various successful and unsuccessful HTTP requests from an Apache (www.apache.org) Web server log file

Beyond the HTTP method and Request-URI, the HTTP header contains additional fields both on the request and response packets. A standard HTTP request header looks like this:

```
GET / HTTP/1.1
Host: www.wiley.com
User-Agent: Mozilla/5.0 (X11; U; Linux i686; en-US; rv: 1.4)
Gecko/20030626 Netscape/7.1
Accept: text/xml, application/xml, application/xhtml+xml,
text/html; q=0.9, test/plain; q=0.8, video/x-mng, image/png,
image/jpg, image/gif; q=0.2, */*; q=0.1
Accept-Language: en-us, en; q=0.5
Accept-Encoding: gzip, deflate
Accept-Charset: ISO-8859-1, utf-8; q=0.7, *; q=0.7
Keep-Alive=300
Connection: keep-alive
```

The first line describes the method and Request-URI, which in this case is a request to retrieve a Web site's root directory (that is, /). Host identifies that the Web site requested is www.wiley.com.

Web content is not yet What-You-See-Is-What-You-Get (WYSIWYG, pronounced *WIZ-zee-wig*). Formatting and other content interpretation varies across Web browsers. Therefore, many Web sites tailor the appearance of a Web page to the specific

browser. The User-Agent field identifies the type of the Web client used, and scripts can be implemented on the server to substitute the Web pages accordingly.

Accept describes each of the data formats that is supported by the browser. This is followed by language preferences. To reduce bandwidth and transfer binaries, many Web sites encode and compress data prior to sending it. Browsers that support this indicate it in the Accept-Encoding field.

ISO-8859-1 is the character set that is the preference for this client. US-ASCII is also a common default for the Accept-Charset field.

Keep-Alive is a TCP timeout option that is associated with persistent connections, which are discussed in detail later in this chapter.

When this request is received, the Web server processes it and sends a response. The response in this case is as follows:

```
HTTP/1.1 301
Location: /WileyCDA/
```

The code 301 informs the Web client that the main page now permanently resides at /WileyCDA/ instead of /. The browser then automatically reissues a request, but this time Request-URI is different.

```
GET /WileyCDA/ HTTP/1.1
Host: www.wiley.com
User-Agent: Mozilla/5.0 (X11; U; Linux i686; en-US; rv:1.4)
Gecko/20030626 Netscape/7.1
Accept: text/xml, application/xml, application/xhtml+xml,
text/html; q=0.9, test/plain; q=0.8, video/x-mng, image/png,
image/jpg, image/gif; q=0.2, */*; q=0.1
Accept-Language: en-us, en; q=0.5
Accept-Encoding: gzip, deflate
Accept-Charset: ISO-8859-1, utf-8; q=0.7, *; q=0.7
Keep-Alive=300
Connection: keep-alive
```

Following the correct request, the Web server issues the following response:

```
HTTP/1.1 200 OK
Date: Wed, 25 Aug 2004 16:06:44 GMT
Server: Apache/1.3.20 (Unix)
Set-Cookie:
JSESSIONID=0000NB14CONYTVM4LW3KGM5VX4I:vpk0qcu;Path=/
Cache-Control: no-cache="set-cookie, set-cookie2"
Expires: Thu, 01 Dec 1994 16:00:00 GMT
Connection: Keep-Alive
Transfer-Encoding: chunked
Content-Type: text/html; charset=ISO-8859-1
Content-Language: en
[ the body of the website ]
```

The response code 200 indicates that the request was processed correctly, and that the requested URI is in the body of the response. Just as the request identifies the type of client used, this response indicates that Apache version 1.3.20 is used for the Web server.

In addition, this response sets the nonpersistent cookie `JSESSIONID` for the entire site. Nonpersistent means that the expiration date is not set for a date in the future, and therefore the cookie will be removed from memory when the browser is terminated. Persistent cookies are written out to the hard drive and are references in subsequent browser sessions. Following the setting of this cookie, all subsequent requests to this site during this session contain the following additional field below `Connection`:

```
Cookie: JSESSIONID=0000NB14CONYTVM4LW3KGM5VX4I:vpk0qcu
```

This allows the Web server to track activity from this browser. Cookies and other tracking mechanisms are explored in further detail later in this chapter.

HTTP implementation

There are two primary releases of HTTP: 1.0 and 1.1. Versions are defined with a “<major>.<minor>” notation and are meant to provide formatting and capability information by the sender for the receiver. Minor numbers are incremented when changes are made that do not affect the overall parsing algorithm, and major numbers are incremented otherwise.

HTTP/1.0 and previous releases are inefficient. Unless unofficially supported by the browser through a keep-alive mechanism, unnecessary overhead TCP chatter occurs with these versions.

As a demonstration, think of an HTTP session as a telephone call. The initial three-way TCP handshake is analogous to the receiver answering, “Hello,” the caller asking, “Is Penny there?” and the receiver responding, “Yes, this is Penny.”

The HTTP portion of the phone call comes after this handshake when the caller asks Penny a question and Penny answers. When the caller has multiple questions to ask, it is most efficient for the questions and responses to occur in a single telephone call.

HTTP/1.0 and older versions instead re-implement the 3-way handshake for each question. This would instead create a conversation that sounds something like the following:

Receiver: Hello?
Caller: Is Penny there?
Receiver: Yes, this is Penny.
Caller: Great, how are you?
Receiver: I am doing well thank you
Caller: Bye
Receiver: Bye <HANG UP>

Receiver: Hello?
Caller: Is Penny there?
Receiver: Yes, this is Penny.
Caller: Will you be attending Stan's party tomorrow?
Receiver: Yes, I would not miss seeing him!
Caller: Bye
Receiver: Bye <HANG UP>

Receiver: Hello?
Caller: Is Penny there?
Receiver: Yes, this is Penny.
Caller: Would you like to ride together to the party?
Receiver: Yes, you pick me up at 6:00pm
Caller: Bye
Receiver: Bye <HANG UP>

When Web pages were first created, bandwidth was restrictive and most pages contained only one or two objects at the most. Although inefficient, this duplication of TCP sessions was not prohibitive at the time. However, now it is not uncommon for a single site to have dozens of objects. Creating an entirely new TCP connection for each object (no matter how large or small) exponentially increases the network traffic, which is unacceptable.

Figure 7-3 illustrates how separate TCP sessions must be created for the transfer of both the Web page and the image located on it using HTTP/1.0.

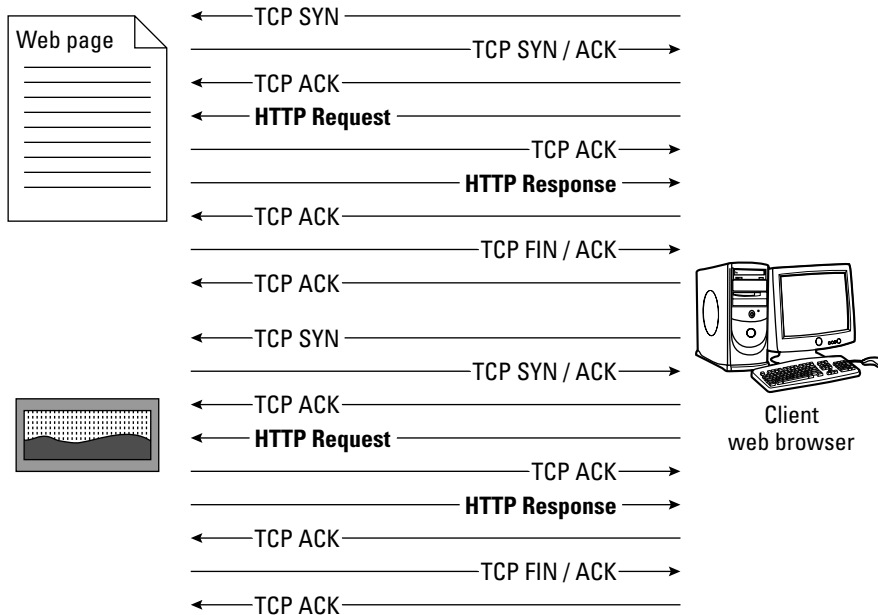

Figure 7-3: HTTP/1.0 inefficiently establishes a new TCP connection for each object received during a Web session. The main Web page is first retrieved, followed by separate connections for each image, and so on. HTTP communication (highlighted above) is minimal compared to the overhead associated with creating and terminating a new TCP connection for each object.

To compound the inefficiencies of HTTP/1.0 and previous versions, TCP was developed to be most efficient over long sessions.

For smaller sized objects, the slow-start algorithm used in TCP actually forces the transfer to operate at its smallest (and hence slowest) capacity. Transactions of this nature will often be completed before the window size can be ramped up to accommodate the true capacity of the network.

Persistent connections

In 1999 the IETF released the standard for HTTP/1.1 as an improvement to deal with these performance issues. This enhancement uses *persistent connections* so that multiple objects can be transferred over each TCP session. In addition to reducing the amount of overhead associated with creating or closing connections, persistent connections provide the ability to maximize window size by already knowing the negotiated maximum. Otherwise, each operation would itself be forced to start slow and negotiate up as was done previously.

What Does “Slow Start” Mean?

Slow start refers to an algorithm that has been built into modern implementations of TCP. It came about after older releases allowed the transmitter to send multiple packets blindly across a network that were up to the publicized window size of the receiver. This is highly efficient when both hosts reside on the same subnet, but when they are separated by a router this can be dangerous. Denial-of-service attacks can take advantage of this queuing and cause a router to run out of memory by sending large packets faster than the router can transmit them.

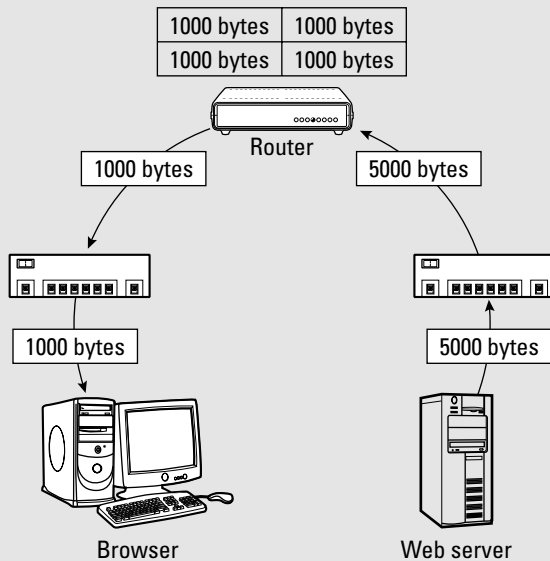

Figure 7-4: Packets that are too large for routers or gateways are divided and the remaining packets are queued to be sent.

If the intermediate router or network is sized to handle a smaller window it must queue up the packet, divide it into multiple packets of an allowable size, and retransmit. This queuing can slow throughput and, even worse, cause the router to run out of memory (a security concern).

To prevent this event from unintentionally taking place, the sender also establishes a size restriction. This restriction is referred to as the congestion window (cwnd) size in the TCP header. This value gets initialized upon the start of a connection as the size of one segment, typically 512 bytes. Every received ACK packet indicates that the size is allowable across the entire path between the two servers, and the value increases exponentially (that is, transmit 1: 1 segment, transmit 2: 2 segments, transmit 3: 4 segments, and so on). Eventually the transmission will be beyond the allowable size of the network, and the sender will not receive an ACK. This enables the sender to identify the maximum window size in an efficient manner. Slow start provides a graceful sanity check that the maximum allowed size by the receiver is an accepted value across the entire network.

You can read more about the slow start algorithm in RFC 2001, at www.faqs.org/rfcs/rfc2001.html.

The previous implementation of HTTP initially tried to accommodate this concept by issuing the keep-alive extension. However, this extension did not deal with the circumstance in which there was more than one proxy between the sender and receiver. In addition, keep-alive was only unofficially supported, which meant that not all browsers accommodated it.

Unless the request header field explicitly indicates the following; HTTP/1.1 will allow multiple requests to be sent across a single TCP session:

```
Connection: close
```

As illustrated in Figure 7-5, the HTTP/1.1 protocol establishes a new TCP connection only at the start of the session. All data for the Web site is passed using this existing connection, which also alleviates inefficient use of the slow start functionality.

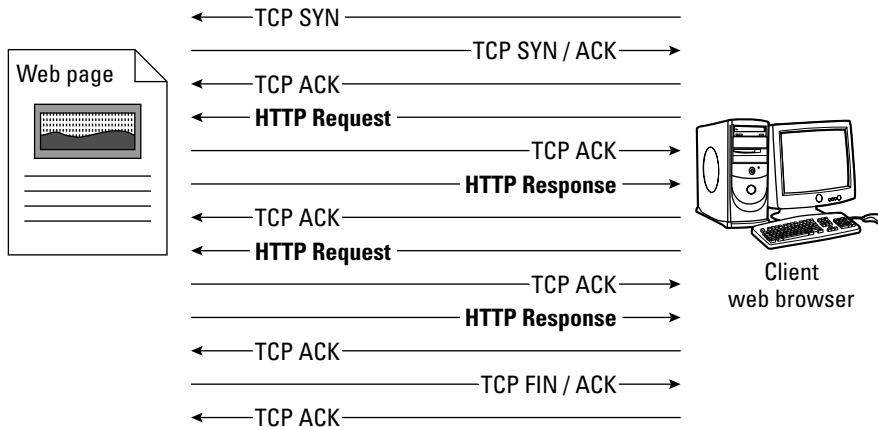

Figure 7-5: The efficient HTTP/1.1 protocol only establishes a new TCP connection at the start of the session.

Each TCP segment can actually contain multiple requests and responses, which *pipelines* the queue of operations. The second major improvement in HTTP/1.1 is that it enables compression of the data being transmitted.

Note

This compression is generally implemented on UNIX-based Web servers using the GNU zip (gzip) algorithm, as defined in RFC 1952. This compression is based on the Lempel-Ziv coding (LZ77) with a 32-bit CRC. Alternatively, a Web site may use `compress` which is an adaptive Lempel-Ziv-Welch (LZW) coding, or `deflate`, which uses the zlib format defined in RFC 1950.

Where Did Hypertext Originate?

Although popularity of the World Wide Web only started in the early nineties, the concept of Hypertext dates back to 1945. It was President Franklin D. Roosevelt's science advisor, Dr. Vannevar Bush, who first proposed the concept in his article "As We May Think" about the design of a future device that he named the memex. As the following caption from this article describes, this device was intended to provide the capability to efficiently store and search for information in a manner similar to that of the human mind:

...It affords an immediate step, however, to associative indexing, the basic idea of which is a provision whereby any item may be caused at will to select immediately and automatically another. This is the essential feature of the memex. The process of typing two items together is the important thing... [the human mind] operates by association. With one item in its grasp it snaps instantly to the next that is suggested by association of thoughts, in accordance with some intricate web of trails carried by the cells of the brain.

Twenty years later, Ted Nelson coined the phrase *hypertext* in his paper "Complex information processing: a file structure for the complex, the changing, and the indeterminate," which was presented at the 1965 ACM 20th National Conference:

...Let me introduce the word "hypertext" to mean a body of written or pictorial material interconnected in such a complex way that it could not conveniently be presented or represented on paper. It may contain summaries, or maps of its contents and their interrelations; it may contain annotations, additions and footnotes from scholars who have examined it. Let me suggest that such an object and system, properly designed and administered, could have great potential for education, increasing the student's range of choices, his sense of freedom, his motivation, and his intellectual grasp...Such a system could grow indefinitely, gradually including more and more of the world's written knowledge.

Two years later, in 1967, a team of researchers led by Dr. Andries van Dam at Brown University developed the first hypertext system, Hypertext Editing System. This research was funded by IBM and later sold to the Houston Manned Spacecraft Center where it was used for the Apollo space program documentation. Around that same time, Doug Engelbart from Stanford University (who invented the mouse) introduced his oN Line System (NLS). This system debuted in 1968 as a "shared journal" that housed over 100,000 papers, reports, memos, and cross references.

Complications occur when a proxy or gateway forwards traffic that is a different version than its own capability. In this case, selection of the version is almost always chosen to reflect the capability of the most recent sender. For example, if the Web server was HTTP/1.1 but the proxy only supports HTTP/1.0, the message is downgraded to HTTP/1.0 because it reflects the highest possible value of its transmitter (which, in this case, is the proxy). Alternatively, the proxy can instead choose to send an error message or tunnel the traffic.

When the transmission is forwarded with a version higher than the originating server, there are several potential outcomes. In the case of caching proxies, gateways have the option of upgrading, and tunnels do not change the version number at all.

The client/server model

The fundamental design for most network-based applications, particularly those on the Internet, is the client/server model. The names client and server are also commonly used to categorize computers on a network based on their functionality.

In this case, there are two categories—those that want something (the clients) and those that have something (the servers). Although popular, this terminology is *technically* incorrect because the servers are also clients of other applications. For our purposes, client refers to the application (Web browser) on the host that is interacting with the remote computer's server application (Web server).

The most prevalent example of a client when it comes to the Internet is a Web browser. As discussed in Chapter 6, a browser is responsible for managing communication between the user and a Web server (see Figure 7-6).

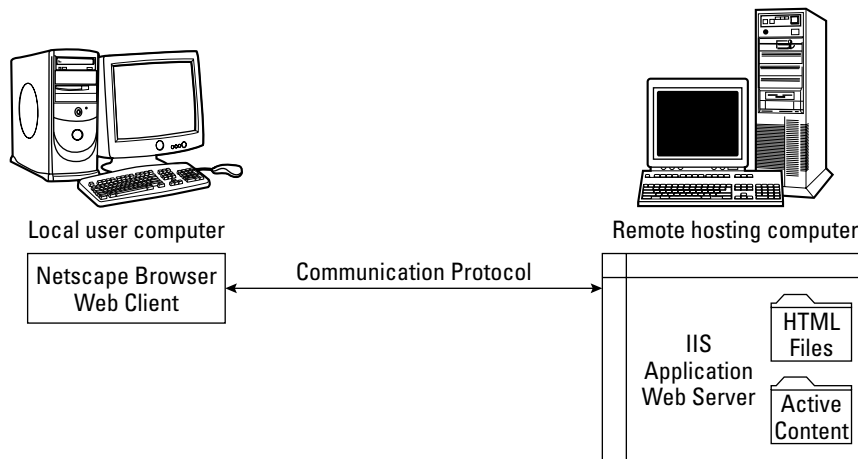

Figure 7-6: Client/Server interaction depicted in Web browsers and servers

Initiation occurs when the user enters a URL (for example, `www.google.com`) into the client browser. The client indicates what it wants from the server by sending a GET request. The server that maintains all of the information responds back to the client with a PUT method containing the requested data.

This client/server relationship can be seen in other common Internet activities such as e-mail. Just as the post office stores and processes physical mail, e-mail is first stored in an electronic mailbox managed by a mail server. E-mail clients, such as Eudora or Outlook Express, send requests to the mail server using a specified protocol (generally SMTP). The mail server processes this request and forwards e-mail to a client where it can be viewed and processed by the user.

Put

In HTTP the well-known `POST` method is used to upload message board postings, credit card and address information for online purchases, and Web-based e-mail. Although not commonly implemented because of security issues, HTTP also provides the `PUT` method for uploading information.

The difference between the two is in the meaning of `Request-URI`. For `POST`, the URI refers to the program on the server that is responsible for receiving and processing the information that you upload (for example, `registration_form.cgi`). For a `PUT` request, the URI actually refers to the location on the server where you would like the information placed.

**Note**

This is of significant concern from a security standpoint because users are able to actively modify the *actual* content of the Web server without intervention.

If absolutely required, servers should only support the `PUT` capability for users to administer their own files and directories. Authoring clients such as Dreamweaver (www.macromedia.com) and Amaya (www.w3.org/amaya) support this feature. Instead of saving the modified page and manually transferring it to the Web site, these clients enable you to save directly to the remote Web site.

Because of obvious security concerns, most servers do not support this functionality remotely by default. However, be warned that some do. For example, by default, the Sambar Server (www.sambar.com) is configured to allow the admin user to put files on the server. This capability must be disabled or the password changed prior to allowing remote access to this server. Attackers prey on configuration errors such as this by scouring the Internet for potentially misconfigured domains that use this type of server.

In general, the concept of allowing a user to upload information without some sort of processing engine (as is the case with `POST`) is a security risk. Even when locations and size restrictions are placed on the `PUT` requests, a malicious user can still potentially use this mechanism to exploit the server. For example, the user could upload a Web page that is purposefully vulnerable. When exploited it could provide unrestricted access to the attacker.

Get

The GET method is associated with retrieving content from a Web server rather than modifying it. As discussed previously, it is used to retrieve pages and other objects such as images from Web servers when a Web client requests them. Because of this, the GET method is itself not a security risk like PUT.

Security concerns associated with GET actions are instead focused on ensuring the integrity and functionality of the server application itself and any active content. GET is still an interface between a potentially malicious user and the server. Any inputable pages involved in this method should be closely analyzed and tested for faults.

Burstable TCP

The popularity of a Web site is difficult to project. This can be especially true for novel ideas that suddenly become the latest craze. Take the “This Land” parody released by JibJab in July 2004. The obscure Web site www.jibjab.com released a parody of Senator John Kerry and President George Bush set to the tune of “This Land Is My Land” by American folk artist Woody Guthrie. This online cartoon movie instantly became a global sensation and launched the Web site into celebrity status.

Within a matter of days, news of their Web site had traversed across the globe. The two brothers that created the site were interviewed on Fox news, CNBC’s Squawk Box, Jay Leno, and other top-rated television shows.

Between this publicity, word of mouth, and e-mail referrals, this site had a monumental spike in network traffic. From the JibJab blog:

Ever since Brian Wilson put us on FOX News, our server has been buckling under pressure, serving millions and millions of movies around the world. It’s amazing to think that two brothers in a warehouse in Santa Monica can create and distribute a cartoon worldwide without the help of a mega-media conglomerate. The Inter-web is a beautiful thing! . . . We’re on track to do 30 terabytes of data transfer this month.

Gregg and Evan Spiridellis
<http://www.jibjab.com/blog>

Rather than being bound to a fixed-size bandwidth, burstable TCP service provides a safety net to clients that allow peak bursts of activity to be handled smoothly without paying the high fees for dedicated access. Fees charged to customers are based on bandwidth utilization and not preset bandwidth requirements. For example, imagine that your company averages 250K/sec worth of traffic each month, but on occasion (following commercials) your Web site utilization can spike to as high as 11mbps. With burstable access, you are only charged a fraction of what you would have to pay for a full 11mbps dedicated line.

The benefit of this is that as the customer you pay only for what you use, and as the provider you have excess bandwidth that can be distributed as needed to other customers.

HTML

HTML is a formatting language used extensively in the World Wide Web. It is an application of the International Standard Organization (ISO 8879) for hypertext, the Standard Generalized Markup Language (SGML).

Instead of physically changing the appearance of the text, it is surrounded with markup symbols, referred to as *tags*, which indicate how it should be displayed. For example, the following formatting would bold a section of text:

```
<B>HTML is also used in many chat programs!</B>
```

The first tag, ``, indicates that the browser should begin bolding text, and the second tag, ``, indicates that it should end bolding. In addition to formatting such as background and foreground configuration, HTML provides symbols to indicate how a browser should display and interpret links and images.

A typical HTML page is composed of a head and body section. The head section contains information about the page such as its title and meta-information used by search engines, and the body contains the actual viewable content on the page. An example format of a typical HTML page follows:

```
<HTML>
<HEAD>
  <TITLE> An example of HTML </TITLE>
</HEAD>
<BODY>
<CENTER><FONT SIZE=25>HTML demonstration</FONT></CENTER>
<BR>
<BR>
HTML is merely a means of formatting.
<BR>
<BR>
Netscape's HTML Central is a good
<A HREF="http://devedge.netscape.com/central/html">guide</A>.
</BODY>
</HTML>
```

Because HTML does not possess any active content, it is a minimal security risk. Note, however, that additional content such as JavaScript and ActiveX objects can be embedded within Web pages, which could potentially be dangerous.

Server Content

Active content on a Web site is composed of server-side executables and client-side executables. The host executing the content should be the most concerned with its security. This section focuses on the server side, which includes Common Gateway Interface (CGI) and PHP.

CGI scripts

The Common Gateway Interface was the first interface designed to provide developers with the capability to produce dynamic content on their Web sites. With this introduction, suddenly pages began to transform from informative but stale HTML to active feedback environments. The first search engines, registration sites, Web-based chat forums, and online database queries were implemented using CGI.

The execution component of a CGI script can be written in any programming language that can execute on the host machine (Perl, Python, Shell, C, C++, and so on). Because of its ability to parse text easily, Perl tends to be the most popular of the choices. To be most effective, this language should be able to read from the standard input stream, output to the standard output stream, and read environment variables. Examples of commonly used environment variables used in active content are listed in Table 7-1.

Table 7-1
Commonly Used Environment Variables

<i>Environment Variable</i>	<i>Purpose</i>
REQUEST_METHOD	How the script was called, usually POST, GET, or HEAD
HTTP_REFERER	URL of the form
REMOTE_ADDR	IP address of the remote client
REMOTE_HOST	Name of the remote client
REMOTE_USER	Authenticated username (if supported)
CONTENT_TYPE	Content type of client-submitted data
CONTENT_LENGTH	Length of the client-submitted content
HTTP_USER_AGENT	Type of browser used by the client

CGI scripts are located in a specified directory within a Web server (usually `/cgi-bin`). Although they are physically separated from sensitive system files, configuration errors can lead to access by malicious users.

PHP pages

CGI is an interface, and PHP is a language. Just as CGI provides the ability to embed Perl and other languages directly into HTML, PHP is directly embedded.

The following example of a PHP page shows how they are commonly implemented. It randomly selects a URL for a book each time someone visits the page.

```
<?
$url = array(
    "http://www.wiley.com/WileyCDA/WileyTitle/
      productCd-0764519956.html",
    " http://www.wiley.com/WileyCDA/WileyTitle/
      productCd-0471493031.html",
    " http://www.wiley.com/WileyCDA/WileyTitle/
      productCd-0471486663.html",
    " http://www.wiley.com/WileyCDA/WileyTitle/
      productCd-047139470X.html ");

$subject = array(
    "HTML",
    "E-Commerce",
    "Java",
    "Testing");

$title = array(
    "- HTML 4 For Dummies, 4th Edition",
    "- E-Commerce: Fundamentals and Applications",
    "- Java Tools: Using XML, EJB, CORBA, Servlets and
      SOAP",
    "- Testing Applications on the Web: Test Planning
      for Internet-Based Systems");

srand(time());
$sizeof = count($url);
$random = (rand()%$sizeof);
print("<center><a href=\"
$url[$random]\">$subject[$random]</a>
$title[$random]</center>");
?>
```

Like CGI scripts, PHP is able to read and interpret environment variables. For example, the following line will display the type of Web client that the individual viewing the page is using:

```
<?php echo $HTTP_USER_AGENT; ?>
```

Client Content

Client-side active content executes directly on the computer of the user that is browsing the Web site. Scripting languages such as JavaScript are either embedded directly into the HTML where they are interpreted by the browser, or executable content is downloaded and run separately. Popular examples of client-side active content include JavaScript, Java, and ActiveX.

JavaScript

The HTML markup tag `<SCRIPT>` is used to identify a section of JavaScript within a Web page. Following is an example that causes the browser to execute an alert box with a message for the user.

```
<HTML>
<HEAD>
  <TITLE> An example of JavaScript </TITLE>
</HEAD>
<BODY>
  <CENTER>This is a simple example of JavaScript</CENTER>
  <SCRIPT>
    alert("This is an example of an alert!")
  </SCRIPT>
</BODY>
</HTML>
```

Security considerations

The primary security issue related to JavaScript is that when viewed on a Web site it has the ability to open new browser windows without your permission. Just by adding the following lines to an HTML file, the Web site `www.google.com` will open in a separate window without any interaction by the user.

```
<SCRIPT>
window.open("http://www.google.com", '' + 0 + '', 'toolbar=0,
scrollbars=1,location=0,statusbar=0,menubar=0,resizable=0,
width=1152,height=864');
</SCRIPT>
```

This is one of the ways that Web sites create pop-up advertisements. While those ads can be annoying, they are generally not security threats. The danger comes when the opened Web site is operated by a malicious user. These types of attacks have been known to be capable of stealing passwords, PINs, credit card numbers, cause the computer to crash, and monitor all activity performed by the browser.

Although all current (known) vulnerabilities have been patched, JavaScript has the potential to access anything that the browser can if a new vulnerability is discovered.

As with any client-side executable, JavaScript should be disabled if high security is a concern and sensitive information is present on the host computer.

Java

Java is a language created by Sun Microsystems in 1991 to provide a method to execute programs without any platform dependence. Although originally intended for small consumer electronic devices such as VCRs, toasters, and television sets, its popularity soared in 1994 when it was used across the Internet.

The sandbox and security

The Java security model is based on the notion of a sandbox. This environment resides on the host computer that is executing the Java application, and is designed to confine the program to a small play area. This play area is the sandbox, and it contains no critical resources. All access is explicitly granted by the user.

By default, the application only has access to the central processing unit (CPU), the display, the keyboard, the mouse, and its own memory. This provides the program with what it needs to run, but does not afford it what it needs to be dangerous.

Trusted applications can be provided larger boundaries and access to additional information. For example, applications that share files or documents may require additional access to the hard drive.

The Java sandbox is composed of the following:

- ♦ **Permissions**—Explicit statements of actions that applications are allowed to execute and resources that they are allowed to access.
- ♦ **Protection domains**—Collections of permissions that describe what actions applications from domains are allowed to execute and resources that they can access.
- ♦ **Policy files**—Contains protection domains.
- ♦ **Code stores**—The sites that the applications are physically stored on prior to execution on the host.
- ♦ **Certificates**—Used to sign code to convey trust to a user that you are the developer of the application.
- ♦ **Key stores**—Files that contain the certificates for Web sites. Key stores are queried to identify who signed the application code.

Figure 7-7 depicts the Java security model.

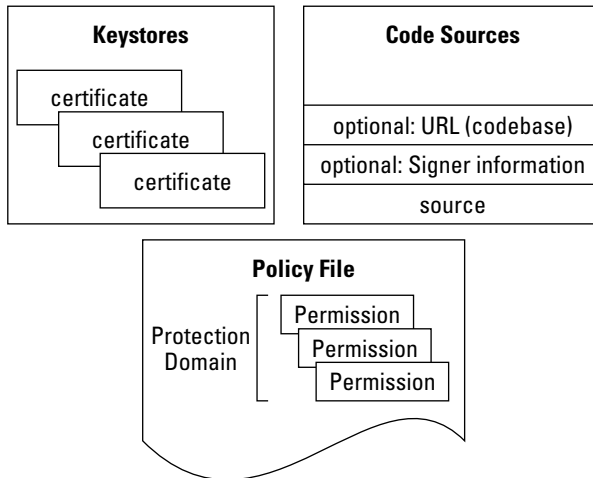

Figure 7-7: The Java security model involves the policy file, protection domain, code sources, key stores, and certificates

Types of Java permissions

Table 7-2 shows the different permissions that are allowed in Java and what the resulting actions are.

Table 7-2 Java Permissions Summary		
<i>Type</i>	<i>Name</i>	<i>Actions</i>
java.io. FilePermission	File to perform action on	Read, write, delete, execute
java.net. SocketPermission	hostname:port	Accept, listen, connect, resolve
java.util. PropertyPermission	Java virtual machine that you want to perform action on	Read, write
java.lang. RuntimePermission	Specific to the class, examples within the core Java API include the following: <i>createClassLoader,</i> <i>readFileDescriptor, exitVM,</i> and <i>setIO</i>	Actions are not used; you either have permission to execute the specific runtime operation or you do not

<i>Type</i>	<i>Name</i>	<i>Actions</i>
Java.awt. AWTPermissions	accessClipboard, accessEventQueue, createRobot, listenToAllAWTEvents, readDisplayPixels, and showWindowWithoutWarningBanner	Not used
Java.net. NetPermission	specifyStreamHandler, setDefaultAuthenticator, requestPasswordAuthentication	Not used
Java.security. SecurityPermission	There are several; popular examples include the following: <i>addIdentityCertificate, getPolicy, setPolicy, setSystemScope</i>	Not used
Java.io. SerializablePermission	enableSubstitution, enableSubclassImplementation	Not used
Java.lang.reflect. ReflectPermission	suppressAccessChecks	Not used
Java.security. AllPermission	None	Not used

ActiveX

ActiveX is one of the most powerful technologies available today. Using it, software can be automatically downloaded, installed, and executed. ActiveX can be thought of as a self-installing plug-in. If configured by the browser, Web pages that contain an OBJECT tag are automatically acted upon simply by viewing.

The original Microsoft code name for ActiveX was *sweeper*. It was formally announced at a San Francisco conference in 1996. Although most consider it a browser-related technology, it is also a part of Microsoft Outlook, Outlook Express, and Office applications.

The ActiveX OBJECT tag requires the following attributes:

- ♦ **CODEBASE**—The URL of the program that is to be downloaded and executed on the host computer
- ♦ **CLASSID**—A unique value assigned to each ActiveX component that is used to specify what controls you are using
- ♦ **ID**—A value that can be arbitrarily set to any value that is used to identify the control for use within a Web site

- ♦ **TYPE**—An optional field that is almost always set to `application/x-oleobject` (the MIME type for ActiveX controls)
- ♦ **WIDTH**—The width of the ActiveX visual object on the page
- ♦ **HEIGHT**—The height of the ActiveX visual object on the page
- ♦ **ALIGN**—The alignment of the ActiveX visual object on the page

ActiveX pages also require the `PARAM` tag, which has a `NAME` and a `VALUE` attribute. `NAME` is used to specify a control that is to be set, and `VALUE` specifies what it should be set to.

Following is an example of an embedded Flash movie that downloads and runs Shockwave. Also demonstrated is that despite the common misconception, not all Web sites that implement ActiveX are malicious. This sample is actually used to execute a scrolling cartoon menu bar on www.sesamestreet.com.

```
<OBJECT classid="clsid:D27CDB6E-AE6D-11cf-96B8-444553540000"
codebase="http://download.macromedia.com/pub/shockwave/cabs/flash/swflash.cab#version=4,0,2,0"
ID=movie WIDTH=770 HEIGHT=310>
<PARAM NAME=movie
VALUE="/sesamestreet/scroller/swf/scroller_page.swf?server%5Fname=www%2Esesameworkshop%2Ecom&swf%5Fpath=%2Fsesamestreet%2Fscroller%2Fswf&name=games&filter=6&focus%5Fitem=&num%5Ffilters=6">
<PARAM NAME=quality VALUE=high>
<PARAM NAME=bgcolor VALUE=#3366CC>
<PARAM NAME=menu VALUE=false>
<EMBED
src="/sesamestreet/scroller/swf/scroller_page.swf?server%5Fname=www%2Esesameworkshop%2Ecom&swf%5Fpath=%2Fsesamestreet%2Fscroller%2Fswf&name=games&filter=6&focus%5Fitem=&num%5Ffilters=6" quality=high bgcolor=#3366CC WIDTH=770 HEIGHT=310
NAME=movie TYPE="application/x-shockwave-flash"
PLUGINSOURCE="http://www.macromedia.com/shockwave/download/index.cgi?P1_Prod_Version=ShockwaveFlash"></EMBED></OBJECT>
```

When it comes to security, ActiveX applications are digitally signed using the Authenticode system. The benefit of this is that it provides the user with a measure to verify the identity of the certificate's signer, but it does not prevent against malicious software in the application.

Without paying close attention, you may see only the name "Microsoft Corporation" and not realize that this message is actually indicating that the certificate has not been authenticated. Accidental consent of an unverified `OBJECT` can give a malicious user full access to your computer.

When valid authentication occurs, the Authenticode system allows you to determine who signed the object. Because the signature is actually applied to a cryptographic checksum of the object, you are also guaranteed that it has not been modified since the signing took place. However, if you chose to accept an object from a malicious Web site, this mechanism will not protect you against their attack.

Similarly, when you purchase a vehicle from a neighborhood car dealer and are provided a warranty, you are not protected against the car breaking down. However, you know exactly where to go and have it fixed if it does. Accepting an object from an unknown entity is similar to deciding to purchase a vehicle from someone that just happens to drive by your house. Even though this individual presents you with a paper copy of a warranty, you may be wary that their vehicle is not trustworthy. The warranty is useless without knowledge that it is supported by a trustworthy entity.

The example Web page is based on the Microsoft Internet Explorer “rotating e” developer’s example. A sample section responsible for displaying and rotating the “X” in ActiveX is listed here:

```
<SCRIPT LANGUAGE="VBScript">
Sub Window_OnLoad()
    call SG7.Scale(0.50, 0.50, 0.50)
    call SG7.Rotate(90, 90, 90)
    RotateAll
end sub
Sub RotateAll
    Call SG7.Rotate(4,6,2)
    FILK = Window.SetTimeout("Call RotateAll", 10,
"VBScript")
End Sub
</SCRIPT>
<OBJECT id=SG7 STYLE="POSITION:ABSOLUTE; HEIGHT: 100%; LEFT:
600; TOP: 55; WIDTH: 100%; ZINDEX: 1" CLASSID =
"CLSID:369303C2-D7AC-11D0-89D5-00A0C90833E6">
<PARAM NAME="Line0001" VALUE="SetLineStyle(0)">
<PARAM NAME="Line0002" VALUE="SetFillColor(0, 0, 0)">
<PARAM NAME="Line0003" VALUE="SetFillStyle(1)">
<PARAM NAME="Line0004" VALUE="SetFont('Arial', 700, 700, 0,
0, 0)">
<PARAM NAME="Line0005" VALUE="Text('X', -95, 87)">
</OBJECT>
```

This particular example is noteworthy because it relies completely on VBScript and controls available within the browser itself. This means that no actual source code has to be downloaded from the Web server. Therefore, the user is not prompted to accept a certificate prior to execution.

State

Web sites need to be able to keep track of users connecting to the site multiple times or accessing multiple pages. This is not built into HTTP and applications such as online banking and e-commerce need this functionality, which is called state. State is discussed in the following sections.

What is state?

State is the current status of a specific instance of an application. Examples of state can be found everyday in human interaction. Every action that you make or respond to is recorded and used to shape the way that you approach the future. For example, imagine that a telemarketer calls you and you dismiss the offer. If that telemarketer immediately calls back and asks the same question again, you get upset because your state indicates that you have already experienced this event and the telemarketer should remember that you are not interested.

Just as you maintain a memory for state in everyday life, an application must have dedicated memory to do the same. This can take place in the form of a file, entry in a database, or a buffer in memory. This memory can be expensive and, therefore, most applications do not maintain state.

How does it relate to HTTP?

HTTP is a stateless, sessionless protocol that relies on the use of external authentication mechanisms, such as tokens, to identify clients and their current state. This means that each transaction is completely unique and that after the transaction occurs, neither the browser nor the server maintains a memory of where it left off. Each new Web page is processed without any memory of past history. You may ask yourself how this can be because your shopping cart on www.amazon.com is capable of maintaining its contents from one session to another, but this is accomplished through external mechanisms such as cookies and so on, not within the protocol itself.

What applications need state?

Any application that requires the association of multiple pages by a single user requires state. For example, it takes a specialized session tracking system to correlate your shopping cart with your billing information on a Web site. State tracking becomes increasingly complex when the Web site is a server farm composed of multiple coordinating Web servers instead of a single entity. Multiserver environments are especially challenging for applications such as Microsoft Internet Information Services (IIS), which are only capable of tracking session state across a single server. What happens if WebServer1 serves the shopping cart, but WebServer2 collects the billing information? Generally, a session manager database is implemented in SQL to maintain congruency across the servers.

Tracking state

An important concept to remember when it comes to the Internet is that every transaction is logged somewhere. Because HTTP is stateless by design, this tracking must be done by external mechanisms. Web sites equate state with a session. Security issues associated with each session include creating a new session or security identifying a participant in a previous session, identification of a participant (or concurrent participants) in an ongoing session, and terminating a session.

Cookies

A cookie is made of ASCII text (up to 80k per domain) that can be stored all in one file or stored in individual files, depending on the browser. They are used to maintain information on items such as the following:

- ♦ A shopping cart
- ♦ Advertising information
- ♦ User name/password to a site
- ♦ Preference information
- ♦ A tracking ID for your computer

Cookies can contain either the actual information to be passed (for example, your user name) or they can contain an index into a database on the server. Both are commonly used, and each has its benefits. By storing actual information in a cookie on the user's hard drive, the server does not need to retain it in a central location. This is often preferred by privacy advocates that have concerns about growing databases of personal information. However, the downside to this means the information must be openly passed each time the user accesses the Web site. By passing only an index to the server, any attacker intercepting the transmission will not gain any useful information.

How do they work?

Web servers send cookies to your client browser either by embedding them directly into the response from an HTTP request, or through scripts executing on the Web site. After a request is made, the cookie portion of the response is set in the Set-Cookie header with the following fields:

- ♦ **expires=** — When the cookie should be removed from the hard drive
- ♦ **domain=** — The domain associated with the cookie (usually left blank and assumed to be the domain that sent it)
- ♦ **path=** — Indicates the pages that should trigger the sending of the cookie

Following is an example of a set of cookies that I received when I visited the Web site www.1800flowers.com for the first time:

```
HTTP/1.1 200 OK
Server: Microsoft-IIS/5.0
Date: Thu, 19 Aug 2004 12:35:39 GMT
P3P: policyref="http://www.1800flowers.com/w3c/p3p.xml",
CP="CA0 DSP COR CURa ADMa DEVa PSAa PSDa IVAa IVDa CONo HISa
TELo OUR DELa SAMo UNRo OTRo IND UNI NAV"
Content-Length: 679
Content-Type: text/html
Expires: Thu, 19 Aug 2004 12:35:39 GMT
Set-Cookie: 800fBanner=+; expires=Sat, 21-Aug-2004 12:35:38
GMT; path=/
Set-Cookie:
ShopperManager%2Fenterprise=ShopperManager%2Fenterprise=U38Q1
8QHW7S69G0GPWBXMBR30M23J1; expires=Fri, 01-Jan-2010
05:00:00 GMT; path=/
Cache-control: private
```

To show you how cookies can be used as a convenience to the user, see the following example of a cookie passed when I visited www.weather.com to check my local forecast:

```
GET / HTTP/1.1
Host: www.weather.com
User-Agent: Mozilla/5.0 (X11; U; Linux i686; en-US; rv:1.4)
Gecko/20030624 Netscape/7.1
Accept:
text/xml,application/xml,application/xhtml+xml,text/html;q=0.
9,text/plain;q=0.8,video/x-
mng,image/png,image/jpeg,image/gif;q=0.2,*/*;q=0.1
Accept-Language: en-us,en;q=0.5
Accept-Encoding: gzip,deflate
Accept-Charset: ISO-8859-1,utf-8;q=0.7,*;q=0.7
Keep-Alive: 300
Connection: keep-alive
Cookie: UserPreferences=3%7C%20%7C0%7Ccrea1%7Cfast%7C-1%7C-
1%7C-1%7C-1%7C+%7C%20%7C+%7C%20%7C%20%7C-
1%7Cundeclared%7C%20%7C%20%7C%20%7C; LocID=22305;
RMID=4453d3f04005fbb0
```

Because I had been to this site before, the cookie on my hard drive already contained an entry for this Web site. Therefore, when I went this time it automatically passed over my LocID, which happens to be the zip code that I checked the weather for previously. This provides a convenience to me so that I do not have to enter my zip code each time I want to check my local weather.

As you can see from the preceding example, cookies are passed within the HTTP protocol during Web site requests or responses.

Cookie security

As the recipient of a cookie, the only security concern that you should have is the lack of privacy that you may experience. Cookies do not contain executable code and cannot be run by attackers. Also, they are not able to access any files on your hard drive. They are simply a means for Web servers to track your previous activity on their site. Because your hostname and IP address may change depending on your Internet service provider (ISP), they are a secondary means of identification.

One key to remember is that the cookies themselves are stored on the user's computer. Therefore, they can be removed, created, or edited at will by the user. This can be especially dangerous if the cookie contains an index into a database. For example, if user A has a cookie set with an ID of 500, that user can change that ID to be 501 instead. This means that when the user now accesses the Web site, his or her transaction is identified with the user associated with ID 501.

This is commonly referred to as *cookie poisoning*. It is a method of attacking Web servers by impersonating cookies for legitimate users. Attackers that do this can sometimes gain personal information about users and, even worse, execute new actions as if they were the impersonated user. An example of this type of attack was launched against the Verizon Wireless (www.verizonwireless.com) Web site in early September 2001 when Marc Slemko, a Seattle-based software developer, posted this vulnerability to a security mailing: the "token" that the Web site used to track customers accessing their account information online was trusted and had no authentication checks.

```
http://www.app.airtouch.com/jstage/plsql/ec_navigator_wrapper
.nav_frame_display?p_session_id=223344556&p_host=ACTION
```

By merely changing this token and accessing the Web site, an attacker was able to browse sensitive customer billing and account information. To combat this, most cookies are now protected by a mathematical HASH that can identify any modifications, but they should still always be treated as suspect.

Some cookies also suffer from another weakness; they are based on timestamps, or improperly randomized data.

Where are the cookies stored?

Each Web client has its own method for storing cookies. When a cookie does not have an expiration date set for it, it is only temporarily stored within a browser's memory. However, cookies that have expiration dates set remain on your hard drive long after you have visited the Web site. Table 7-3 lists a collection of cookie locations for the most common browsers.

Table 7-3
Cookie Jar Locations

<i>Web Client</i>	<i>Cookie Jar Location</i>
Netscape Navigator on Windows	In a single file called cookies.txt
Netscape Navigator on Mac OS	In a single file called MagicCookie
Netscape Navigator or Mozilla on UNIX	In a single file called <i>cookies.txt</i>
Internet Explorer	In individual files within a directory named Cookies

Web bugs

A *Web bug* is a euphemism for an invisible eavesdropping graphic embedded in a Web site, e-mail, or word processing document. Also called clear GIFs, invisible GIFs, beacon GIFs, and 1-by-1 GIFs, they are hypertext images that are generally 1-by-1 pixel in size. Web bugs can be used to track the following:

- ♦ The IP address of the computer that opens the image within the Web site, e-mail, or word processing document
- ♦ The time the computer opened the image
- ♦ The type of browser that the user opened the image with
- ♦ Any previous cookies for that site

In addition to the obvious tracking images displayed on the page, this HTML e-mail contains the following Web bug:

```
<BODY><B>From:</B> Orbitz
[Orbitz@email.orbitz.com]<BR><B>Sent:</B> Wednesday,
July 23, 2003 5:40 PM<BR><B>To:</B>
bugtraq@comcast.net<BR><B>Subject:</B>
FLIGHT DEALS: Vegas, LA, Orlando, and more!<BR><A
href="http://ad.doubleclick.net/jump/N2870.or/B914513.8;sz=1x
1;ord=[timestamp]?"><IMG
src="http://ad.doubleclick.net/ad/N2870.or/B914513.8;sz=1x1;o
rd=[timestamp]?"
border=0></A>
```

In this case, Doubleclick (the company responsible for most of the banners that appear on Web sites) has stored a 1-by-1 pixel image that is invisible to the naked eye. Nonetheless, by accessing this page, this pixel is retrieved from the Doubleclick

ad server and a timestamp is stored. This information is used to tell Orbitz exactly when I viewed this e-mail. Web bugs such as this are also used to track where e-mails get forwarded. Because Microsoft Word also enables embedded HTML, Web bugs can also be used in documents to find out exactly when they are opened and who opens them.

URL tracking

URL tracking is used to determine when, how often, and who is viewing a Web site. This tracking can be used to combine data from banner ads, newsgroup postings, and Web sites to determine how people are accessing your site. Data within the HTTP header is collected to associate the following:

- ♦ Browser types
- ♦ Operating systems
- ♦ Service providers
- ♦ Dates
- ♦ Referrers

When analyzed, this information can provide insight into improvements that can be made to increase advertising and response rates.

Hidden frames

Another option to maintain state is through the use of hidden frames. The benefit of this approach is that it does not rely on any object left on the user's computer to operate. Data is simply passed from page to page as the user browses across the Web site. This method lends itself well to shopping cart instances, but does not provide the ability to track once the user exits the browser.

A hidden frame can be implemented in HTML by dividing the page into visible frames that require 100 percent of the browser space, and defining a second frame that requires 0 percent of the space. Because this frame is not allocated any room within the browser it is not visible, yet it maintains attributes as if it were. An example of this can be seen in the following HTML:

```
<HTML>
<FRAMESET ROWS="100%,*" FRAMESPACING="0">
<FRAME NAME="BROWSER" SRC="MAIN.HTM" SCROLLING="AUTO">
<FRAME NAME="HIDDEN" SRC="TRACKING.HTM">
</FRAMESET>
</HTML>
```

Both the “main” and the “tracking” pages are visited, but only the main page is visible. When the user clicks on links on the main page or progresses through the process of purchasing items, only the top frame is changed. The tracking frame remains active as an open session and is, therefore, able to maintain state for the duration of the activity.

Hidden fields

Similar to hidden frames, hidden fields are commonly used to maintain the state of a Web session. Following is an example of how hidden fields are used by `www.google.com`:

```
<HTML><HEAD><meta http-equiv="content-type"
content="text/html; charset=UTF-8"><title>Google</title>
...
<input type=hidden name=h1 value=en>
<input type=hidden name=ie value="UTF-8">
<input maxLength=256 size=55 name=q value=""><br>
<input type=submit value="Google Search" name=btnG>
...
</html>
```

When a query term is entered into the search form and the submit button is pressed, the Web site also submits tracking values for the variables named `h1` and `ie`. These values are used to indicate the language and character encoding with which subsequent pages should be displayed. Many browsers display information about hidden fields that can be obtained using the View menu.

Attacking Web Servers

A Web server is a target for attack because of its high value and high probability of weakness. As it turns out, the Web servers that provide the highest value also provide the highest probability of weakness because they rely on multiple applications.

Account harvesting

Harvesting information about legitimate accounts is the first step an attacker takes toward maliciously impersonating a user and gaining system access. This harvesting can be done by enumerating directory structures, investigative searching, and taking advantage of improper identity authentication.

Enumerating directories

A common mistake made by Web site administrators is to allow directory listings. By default, any page named `index.html` or `index.htm` within a directory will be

displayed. If this file does not exist and directory listings are allowed, the Web site may accidentally leak sensitive information.

Open directories such as this can be extremely dangerous because they may display files that an administrator does not intend to be available to users.

Investigative searching

Pieces of information posted on the Internet are rarely forgotten (even years after being identified by a caching search engine). As a form of reconnaissance against a site, attackers will often harvest user names by using Web sites to search for e-mail addresses. Simple searching on the partial e-mail address `@maia.usno.navy.mil` quickly turns up over a dozen e-mail newsgroup postings which each provide a unique user name that can be used in an attack. In addition, Web administrators often place e-mail addresses and sensitive information in the comments Web pages, which can provide an attacker with additional ammunition against a site.

Faulty authorization

Mistakes in authorization can lead to account harvesting or, even worse, impersonation. As previously discussed in the “Cookie security” section, improperly implemented tokens can be used to gain or upgrade access to a Web site.

SQL injection

Structured Query Language (SQL) is the American National Standards Institute (ANSI) standard for database query languages. Implemented in Access, Microsoft SQL Server, Oracle, Sybase, and Ingres, this standard has been accepted industry wide. Statements written in SQL are capable of adding, removing, editing, or retrieving information from a relational database.

For example, the sample database provided in Table 7-4 is an example of a database.

<i>First</i>	<i>Last</i>	<i>Location</i>	<i>Organization</i>
Molly	Carroll	22305	University of Science
David	Michaels	45334	International Sales Corporation
Barbara	Richards	35758	Tungsten Tidal
Margaret	Carroll	44506	Association of Metallurgical Science

The following SQL command will return the entries for customers Molly and Margaret Carroll:

```
select * from customerinfo where last='Carroll';
```

SQL injection occurs when a malicious user purposefully enters data into this table that will cause an error in its processing. For example, suppose that this information was collected through online registration for an International Metallurgical Convention.

If David Michaels had been a malicious user, he may have tried to *inject* SQL into his input by entering the following:

```
First Name:    David
Last Name:     Mi'chael's
```

Now the query string for this element has become the following:

```
select * from customerlist where last='Mi'chael's'
```

However, with the added single quote, this statement is syntactically incorrect and will result in an error:

```
Server: Msg X, Level X, State 1, Line 20
Line 20: Incorrect syntax near 'chael's'
```

This error would be even more serious if the malicious user were to add a semicolon and a command following the single quote that would be executed by the server:

```
First Name:    David
Last Name:     Mi'; shutdown--
```

Web sites that use SQL as a means of authentication are just as vulnerable. Take the following authentication query, for example:

```
Var login="select * from users where username = '" + username
+ "' and password = '" + password + "'";
```

The user can simply add another condition to the query string, which makes it always true to grant access:

```
First Name:    David
Last Name:     ' or 1=1--
```

E-commerce Design

You must consider several design issues and decisions when developing a design for an e-commerce site. Assuming that there is no existing infrastructure, the prime design factors will be based on requirements, budget, and available expertise. More often than not, requirements tend to fall by the wayside and decisions are based solely on available resources (both budget and personnel).

Important decisions in an e-commerce design include the following:

- ♦ Where will the Web site physically reside?
- ♦ What kind of operating system will be used?
- ♦ What Web server will be used?
- ♦ How will active content be implemented?
- ♦ What is the procedure for maintenance and integrity assurance?

Physical location

Deciding where to physically locate the e-commerce site is a simple trade-off between resources and control.

As the dedicated budget and personnel increase for a site, hosting can progress up the steps from a virtual server, which offers little control over security, to a complete do-it-yourself solution that provides total control.

Virtual hosting

If budget and expertise are limited, a virtual hosting service may be a good fit. In this circumstance, a single server that is located at the hosting company is shared across several domains. As the client, you are responsible for supplying your own domain (for example, `www.e-company.com`) and the content of the site. Costs associated with this service range from \$5 per month to several hundred depending on disk usage, traffic, and additional services that you require.

Several limitations are associated with this arrangement. First, because this is a low-cost solution designed for smaller clients, bandwidth may be limited. One or two spikes of traffic may cause the virtual Web server to become overwhelmed. When it comes to e-commerce, any delay in service can cost revenue. Second, because you do not own the machine, you are subject to configuration and software provided by the hosting company. If you need to implement something unique, this may be an obstacle. Also, by sharing the computer with others and not administering it yourself, your control over the security of the Web site is out of your hands.

This can be especially dangerous because your site's reputation directly influences how willing customers will be to purchase online from you. If you knew that a Web site had a problem with security would you buy from it?

Dedicated server

The next step up in the hosting arena is to rent a dedicated server. Like virtual hosting, the provider owns the machine, but your company has the ability to dictate the configuration of it. Security concerns are also decreased because the server is dedicated to your purpose, and only your company has access to it. However, because you are not responsible for maintaining the server you are reliant on the security expertise of the hosting administrator. Although these administrators are highly trained, the risk of a configuration error jeopardizing your site remains out of your hands. Fees associated with dedicated servers start around \$75 per month.

Co-Location

Co-location is a good intermediate solution for companies that want control over the software and administration of their Web servers, but do not have their own dedicated facilities. The provider arranges a network connection and physical storage space, but you own the hardware and software. Additionally, you are responsible for the site's maintenance and security.

One benefit to using this service is that special measures are generally taken to ensure uninterrupted power and Internet service. Providing this quality of service at your physical business location can become costly.

Other than the resources necessary to maintain the site, the only big drawback is lack of physical control. This also means that administration must be done remotely through secure protocol. Fees associated with co-location range in price from \$75 per month to several thousand depending on bandwidth and physical space utilization.

Do it yourself

For companies able to dedicate resources to controlling all security aspects of a server, there are many components to consider.

- ♦ Determine how to provide proper physical security.
- ♦ Find an ISP with ample bandwidth.
- ♦ Select hardware:
 - Intel compatible, Sun SPARC, Macintosh, and so on
 - Processor speed and number of processors
 - RAM and hard drive space
 - Network connectivity

- ♦ Select an operating system (Windows, Solaris, Linux, and so on).
- ♦ Select a Web server (Apache, Microsoft IIS, Netscape Enterprise, and so on).
- ♦ Select a method of providing active content (Java and so on).

Summary

Companies of every size use a Web server to provide information to the public. Because Web servers are so popular, they are also a common point of compromise for attackers to go after. Therefore, it is critical that Web sites be properly secured, and a key step in doing that is to understand how and why Web applications work. This chapter detailed the critical areas of Web security and what needs to be done to deploy a secure Web server.



E-mail Security

Along with Web browsing, e-mail has made the Internet popular, widespread, and indispensable for most users. Despite its critical role in the typical Internet user's life, e-mail is comparatively insecure.

The E-mail Risk

E-mail is widely used and has a well-defined and universally implemented protocol. Therefore, it should be a prime target for hackers developing attacks. Attacks on e-mail focus on two areas: the delivery and execution of malicious code (malcode) and the disclosure of sensitive information. The latter gets little publicity because it is easily done and does not require a sophisticated attack.

Data vulnerabilities

E-mail has great potential risk due to the very sensitive nature of the data or information that is transmitted. E-mail can reveal a huge amount of company and personally sensitive data. For example, consider only a few common items in e-mail traffic:

- ◆ **Whom you correspond with** — Can be used in expanded attacks.
- ◆ **What you think about other people** — Few people would want their personal opinions made public.
- ◆ **Business strategies** — How to win a contact.
- ◆ **Informal policies** — Many a whistle-blower has used e-mail to establish the existence of a company policy that was not written down or recorded in any place other than e-mail.



In This Chapter

E-mail risks

E-mail protocols

E-mail authentication

Operating safely
when using e-mail



- ♦ **Who are allies or enemies**—People tend to be brutally honest in e-mails, more so than in a memo or other written policy.
- ♦ **Who is being deceived and misled**—Persons tend to set the record straight in e-mail. Explanations of ambiguous policies are clearly explained.

Simple e-mail versus collaboration

The security risks associated with e-mail are often confused with the risks associated with collaboration tools that also serve as e-mail clients. Microsoft Outlook is one such tool. In the “Outlook 98/2000 E-Mail Security Update” white paper (September 2000, Microsoft Corporation), Microsoft states the following:

In addition to providing industry-leading e-mail and group scheduling—the most popular collaboration applications today—the Microsoft® Outlook® 2000 messaging and collaboration client allows users to connect to, communicate with, and collaborate with other users.

Microsoft Outlook is definitely a collaboration tool, not merely an e-mail client. Some of the many features and functions within the application are as follows:

- ♦ **E-mail folders**—The e-mail capability in Outlook
- ♦ **Contacts**—A personal database of people and their related information
- ♦ **Calendar**—A database storing appointments and meetings
- ♦ **Journal**—A simple editor with text storage
- ♦ **Notes**—A simple editor with text storage
- ♦ **Tasks**—A simple database of short text with date, priority, and so on
- ♦ **Net, Public, and Personal folders**—File-sharing capability
- ♦ **Newsgroups**—Access to public postings to news groups

If Outlook were marketed as a collaboration tool, as opposed to an e-mail client, the public would be more wary of the security that is built into the application. However, when the masses think of Outlook only as an e-mail client, it avoids the security scrutiny that would accompany a collaboration tool. E-mail is more inherently secure than collaboration.

The following are two issues to consider when comparing e-mail and collaboration tools:

- ♦ The acquisition and propagation of malcode
- ♦ The loss of privacy data

Attacks involving malcode

E-mail, as defined by the Network Working Group's RFCs, is implemented in simple ASCII text. ASCII text cannot be executed directly. This can be a serious impairment for malcode, which needs to be executed, propagate, or do damage. Therefore, e-mail at its very basic core is safe because it does not transmit directly executable (binary) code.

The following is some sample plain text script that might be embedded in an e-mail message:

```
/**
 * Browser specific detection
 * and printing of Style Sheets
 */
bName = navigator.appName;
bVer = parseInt(navigator.appVersion);
if (bName == "Netscape" && bVer >=3) {
    window.location=error;
} else if (bName == "Netscape" && bVer >=1) {
    window.location=error;
}

function isUnix() {
    var Unixes = new Array("SunOS", "HP", "Linux");
    var $flag = false;
    for (var i=0; i < Unixes.length; i++) {
        if (navigator.appVersion.indexOf(Unixes[i]) != -1) {
            $flag=true;
            break;
        }
    }
    return $flag;
}
```

This text, when transmitted in e-mail, does not in itself cause any execution to take place. To the network, this script is just an ASCII e-mail. The mere fact that the words put together make a script does not inherently make it dangerous. A user would not expect that simply putting the word *shutdown* in the middle of an e-mail message would actually shut down a device that handles the e-mail as it is transmitted across the country.

Malcode can (and usually does) spend part of its life in ASCII form. When in this form, the malcode will either be a plain text script or an encoded block. The following shows an e-mail received with an encoded binary embedded as an attachment:

```
Subject: access
From: tmp@atrc.sytexinc.com>
```



```

To: Jim - ATRC <example@atrc.sytexinc.com>
Content-Type: multipart/mixed; boundary="--Hn2QCdYjnPZf/KrrgRe0"
Mime-Version: 1.0

--Hn2QCdYjnPZf/KrrgRe0
Content-Type: text/plain
Content-Transfer-Encoding: 8bit

This is a binary file 'access'....

--Hn2QCdYjnPZf/KrrgRe0
Content-Disposition: attachment; filename=access
Content-Type: application/x-executable-binary; name=access
Content-Transfer-Encoding: base64

f0VMRgEBAQAAAAAAAAAAAAIAAwABAAAAkIMECDQAAAAAYCwAAAAAAAAADQAIAGACgAGAAXAAYAAAAO
AAAAAIAECDSABAJAAAAwAAAAUAAAAEAAAAAwAAAPQAAAD0gAQI9IAECBMAAAATAAAAABAAAAEA
AAABAAAAAAAAAACABAgAgAQIUakAAFAJAAAFAAAAABAAAAEAAAABQCQAAUJkECFCZBAGQAQAHAEA
  <similar lines deleted>
AwAAADSaBAG0CgAABAAAAAAAAAAAAAAAAABAAAAAAAAACrAAAAAQAAAAAMAAAA4mgQIOAoAACgAAAAA
AAAAAAAAAAQAAAAEAAAAsAAAAAgAAAAADAAAAAYJoECGAKAAAAAMAAAAAMAAAAAMAAAAEAAAAAAAAEA
AADAAAAAAAAAAAAAAAAABgCgAAtQAAAAAAAAAAAAAAAAAQAAAAAAAAA=

--Hn2QCdYjnPZf/KrrgRe0--

```

In this e-mail, the binary file “access” is encoded with a common method used for e-mail — base64. This encoding converts the 8-bit binary to the seven bits used in ASCII text (in the very early days of networking, some devices could only handle 7-bit data). Base64 encoding does this conversion by taking triplets of 8-bit octets and encoding them as groups of four characters, each representing 6 bits of the source 24 bits, as shown in Figure 8-1.

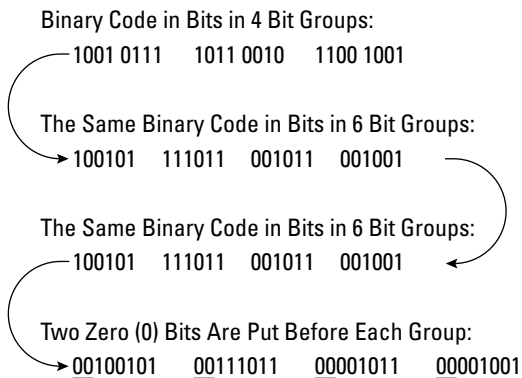

Figure 8-1: Base64 encoding converts 24 bits of binary data to 32 bits of ASCII data.

If left in the base64 encoded form, the malcode is harmless. For the plain text version of the malcode (worms, viruses, and so on) to be executed, it requires a Web browser or collaboration tool. To do its damage, the malcode must be decoded and launched.

When an e-mail client starts adding features to be more of a collaboration tool, such as Outlook, the malcode has many avenues of being decoded and launched. The goal of these tools is to make life easy and convenient for the users. This ease and convenience leads to the tools providing features for the user that the malcode can use to its advantage. Some examples of such features follow:

- ♦ **The automatic population of databases**—E-mail messages may be parsed for special data that needs to be populated into a database. An example of this is when users sign their e-mail with their contact information. This information can be autopopulated to a recipient's contact list.
- ♦ **Other applications are automatically launched**—The e-mail may contain a document such as a spreadsheet. When the e-mail is parsed, the collaboration tool may launch the spreadsheet application and load the document. This is dangerous if the document contains macros or other scripted code.

By some measures, collaboration tools such as Outlook are a huge success. They enjoy a big market share of the e-mail clients in use. But users should be aware that the more features and convenience the application offers, the more of a security risk it is likely to be.

Privacy data

The basic protocols used in e-mail may not be inherently vulnerable to malicious code such as worms and viruses, but the same cannot be said for protecting personal and sensitive data. For many years, the popular e-mail protocol, Post Office Protocol (POP), was used in the clear (not encrypted). Even in today's security-conscious society, most e-mail is still transmitted in the clear.

Figure 8-2 shows a captured IP packet from a simple Simple Mail Transfer Protocol (SMTP) session. The text of the e-mail can be clearly seen in the raw packet.

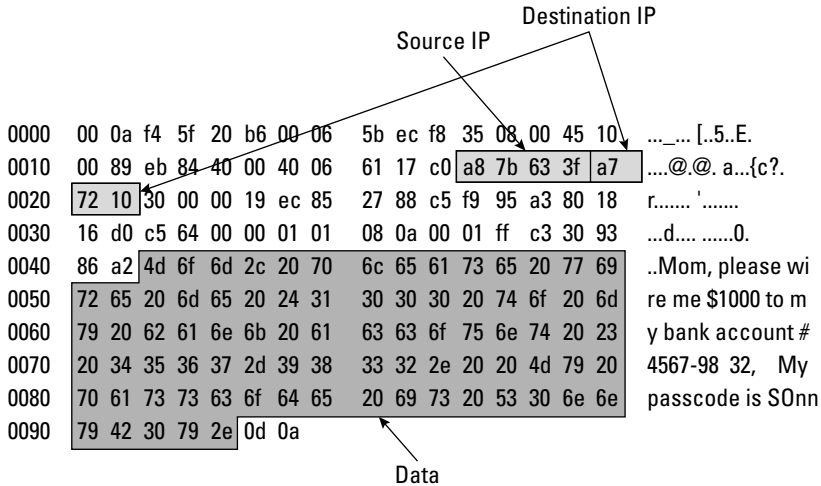

Figure 8-2: A captured IP packet clearly shows e-mail text.

When the message in Figure 8-2 is sent, it can be spread over several packets. The received e-mail, with all the headers, is shown as follows:

```
Return-path: <tmp@the-isp.tmp>
Received: from dedicated199-bos.wh.sprintip.net ([10.228.166.89]) by
        cluster02-bos.wh.sprintip.net (iPlanet Messaging Server 5.2 HotFix 1.21
        (built Sep  8 2003)) with ESMTP id
        <0I1X008AF926WC@cluster02-bos.wh.sprintip.net> for
        tmp@the-isp.tmp; Wed, 04 Aug 2004 12:22:54 +0000 (GMT)
Received: from compaq ([12.28.183.11]) by boded0199snunx.wh.sprintip.net
        (iPlanet Messaging Server 5.2 HotFix 1.25 (built Mar  3 2004)) with SMTP
        id
        <0I1X001FI8Y93G@boded0199snunx.wh.sprintip.net> for
        tmp@the-isp.tmp; Wed, 04 Aug 2004 12:22:54 +0000 (GMT)
Date: Wed, 04 Aug 2004 12:21:55 +0000 (GMT)
Date-warning: Date header was inserted by boded0199snunx.wh.sprintip.net
From: tmp@the-isp.tmp
Subject: Send me money!
Message-id: <0I1X001GF8Z03G@boded0199snunx.wh.sprintip.net>
Content-transfer-encoding: 7BIT
Original-recipient:
        rfc822;@cluster02-bos.wh.sprintip.net:tmp@the-isp.tmp
X-Evolution-Source: pop://tmp@pop.the-isp.tmp
Mime-Version: 1.0
```

Hi,

Mom, please wire me \$1000 to my bank account # 4567-9832. My passcode is S0nnyB0y.

Love, Your Son

When the mail was received, it was transmitted with the POP3 protocol. In this case, the entire e-mail fit into one packet. A portion of that packet follows:

```
0000 00 06 5b ec f8 35 00 0a f4 5f 20 b6 08 00 45 00 ..[.5.. ._ ...E.
0010 04 89 77 0c 40 00 30 06 e1 9e 3f a7 72 11 c0 a8 ..w.@.0. ..?.r...
0020 7b 63 00 6e 80 02 11 05 74 d0 0c 8d 43 3e 80 18 {c.n.... t...C>..
    <similar lines deleted>
0420 0a 0d 0a 48 69 2c 0d 0a 0d 0a 4d 6f 6d 2c 20 70 ...Hi... ..Mom, p
0430 6c 65 61 73 65 20 77 69 72 65 20 6d 65 20 24 31 lease wi re me $1
0440 30 30 30 20 74 6f 20 6d 79 20 62 61 6e 6b 20 61 000 to m y bank a
0450 63 63 6f 75 6e 74 20 23 20 34 35 36 37 2d 39 38 ccount # 4567-98
0460 33 32 2e 20 20 4d 79 20 70 61 73 73 63 6f 64 65 32. My passcode
0470 20 69 73 20 53 30 6e 6e 79 42 30 79 2e 0d 0a 0d is S0nn yB0y....
0480 0a 4c 6f 76 65 2c 20 20 59 6f 75 72 20 53 6f 6e .Love, Your Son
0490 0d 0a 0d 0a 2e 0d 0a .....
```

Because e-mail is transmitted in ASCII text, the words typed into an e-mail message are easily viewed and read, even at the IP packet level. In the preceding sample packet, the text “My passcode is S0nnnyB0y” can clearly be read.

Processing IP packets is a core capability of any device on the network. Capturing and viewing the packets is easily done on a networked workstation; root or administrator access is required, but this is generally not much of a deterrent to a motivated attacker. Because of the way that Ethernet works, if a network interface card (NIC) on a workstation is put into promiscuous mode by the administrator, that workstation will be able to capture every packet on a hubbed network. The problem is slightly more difficult on a switched network, but easily available tools such as ettercap allow attackers to get any packets they need.

This opportunity to capture packets and read e-mail is not limited to a user’s immediate network. The risk of packets being captured can occur anywhere in the transmission between the sender and the e-mail recipient. Most users would be surprised to discover the many connections, jumps, or hops that their e-mail must take to get to the final location. The following is a list of hops to get from the author’s home to his work site, which is only a 10-minute commute (5 miles) away. The command used is **tracert**, which reports every router or gateway that must be traversed to reach the destination:

```
# tracert work
tracert to work 112.128.1.8, 30 hops max, 38 byte packets
 1 68.38.76.1      89.721 ms  19.895 ms  19.704 ms
 2 68.100.0.1     47.083 ms  21.924 ms  16.975 ms
 3 68.100.0.145   50.535 ms  103.814 ms 222.326 ms
 4 68.1.1.6       53.085 ms  23.345 ms  17.810 ms
 5 68.1.0.30      59.535 ms  130.003 ms 192.466 ms
 6 112.124.23.77  61.336 ms  32.410 ms  27.684 ms
 7 112.123.9.62   53.214 ms  26.873 ms  25.215 ms
 8 112.123.14.41  36.065 ms  55.200 ms  202.197 ms
 9 112.118.13.58  59.731 ms  30.929 ms  32.333 ms
10 112.128.1.8    59.731 ms  30.929 ms  32.333 ms
```

So how much of a risk is it to send this information over these 10 hops? If each network has an on-duty administrator (3 shifts), a supervisor (3 shifts), and a help desk of 3 people (3 shifts), that is 150 persons with access to the packets transversing this route. If people who have the technical capability to plug in a laptop on any of these segments and sniff the line are included, the risk probably increases to thousands or tens of thousands. Among tens of thousands of people, it is not unlikely to find someone willing to read unauthorized e-mail. Figure 8-3 illustrates this route and the many network devices that may capture or read the e-mail IP packets.

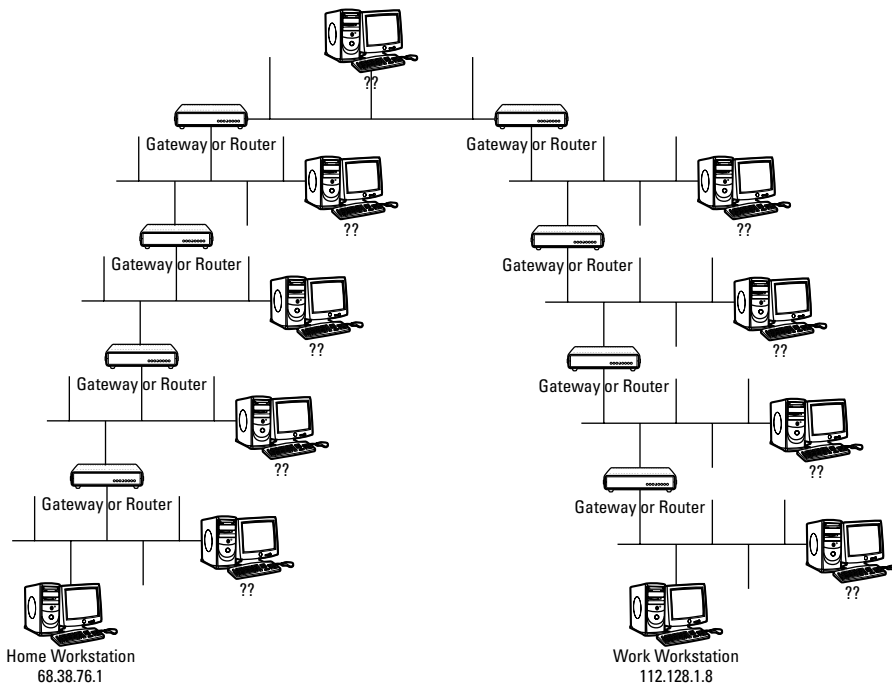

Figure 8-3: Many network devices and people have access to e-mail traffic.

Few users consider how many people might read their e-mail before composing a personal message. Aside from the occasional postcard, would you send a letter in the postal mail without an envelope for privacy? Let's hope our postcards don't read as the one shown in Figure 8-4.

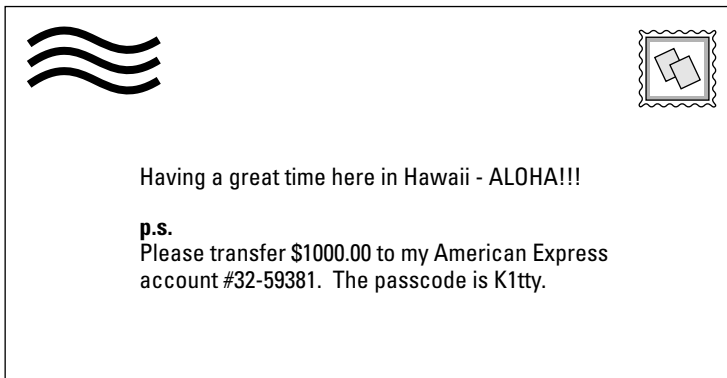

Figure 8-4: Would you put your e-mail on a postcard?

Data integrity

As previously mentioned, the text put into an e-mail message is easily seen and read at the IP packet level. The packet can be read with readily available network administrator tools. It is only slightly more difficult to modify the text in the e-mail by modifying the packets. Some typical information contained in an e-mail message that may be altered is as follows:

- ♦ **Addressees**—The attacker can change or resend the e-mail to a different addressee. E-mail is often confidential and only intended for those listed on the To: line. It is easy to see that changing addressees can create havoc.
- ♦ **Financial amounts**—If the e-mail directs the handling of funds, the dollar amounts could easily be altered. For example, the unsuspecting sender of the e-mail may be authorizing a stockbroker to purchase stock at \$10 per share, but the altered e-mail may read \$50 per share.
- ♦ **Object of financial transactions**—Not only could attackers change the dollar amount of a transaction, but they could also make themselves the object of the money transfer. Consider an e-mail that instructs an agent to transfer \$100 to Bob's account with the account number provided. Attackers could substitute their own names and account numbers.

The capturing and modifying of e-mail can be done either as a man-in-the-middle attack or as a replay attack. Both of these attacks permit the altering of critical data that can be costly and disruptive for the user.

E-mail man-in-the-middle attacks

In a typical man-in-the-middle attack, the attacker must have control of one of the many firewalls, routers, or gateways through which the e-mail traverses. You saw earlier that a simple e-mail from home to work can traverse 10 or more of these

gateways. Other man-in-the-middle attacks do not require control of the gateway; rather, the attacker merely needs to reside on the same local area network (LAN) segment as the user sending or receiving the e-mail. In this case, the attacker can use an Address Resolution Protocol (ARP) spoofing tool, such as ettercap, to intercept and potentially modify all e-mail packets going to and from the mail server or gateway. In an ARP spoof attack, the attacker gets between any two hosts in the e-mail transmission path. There are four possible locations to attack:

- ♦ **Between the e-mail client and server**— This situation assumes that the client and server are on the same LAN segment.
- ♦ **Between the e-mail client and the gateway**— The gateway must be in the path to the mail server.
- ♦ **Between two gateways**— The gateways must be in the path between the client and the server.
- ♦ **Between the gateway and the mail server**— This option assumes the client and the server are not on the same LAN segment and therefore the e-mail traffic must reach the server via a gateway.

Figure 8-5 illustrates the network configuration for the ARP spoofing attack.

In the ARP spoofing man-in-the-middle attack, the e-mail's IP packets are intercepted on their way to or from the mail server. The packets are then read and possibly modified. As discussed earlier, reading the e-mail text in an IP packet is trivial—assuming the e-mail is not encrypted. The attacker has some minor limitations when modifying the packets. For example, the total length of the packet cannot grow to a size larger than the maximum allowable for transmission on the network. This is usually about 1500 bytes. This may require the attacker to be clever when modifying the e-mail text so that the meaning changes, but the length does not.

Man-in-the-middle attacks are best avoided by using encryption and digital signing of messages. If the encryption is sufficiently strong, the attacker will not be able to decrypt and alter the e-mail. Digital signatures ensure the integrity of the body of the e-mail message. This is done by passing the e-mail message through a one-way hashing algorithm. The resulting hash is encrypted with the sender's private key added to the bottom of the e-mail message. The recipient is able to decrypt the hash with the sender's public key and verify the e-mail to have been unaltered. An attacker could not alter the message or the hash (digital signature) without being detected. Figure 8-6 illustrates how a digital signature is created and attached to the e-mail.

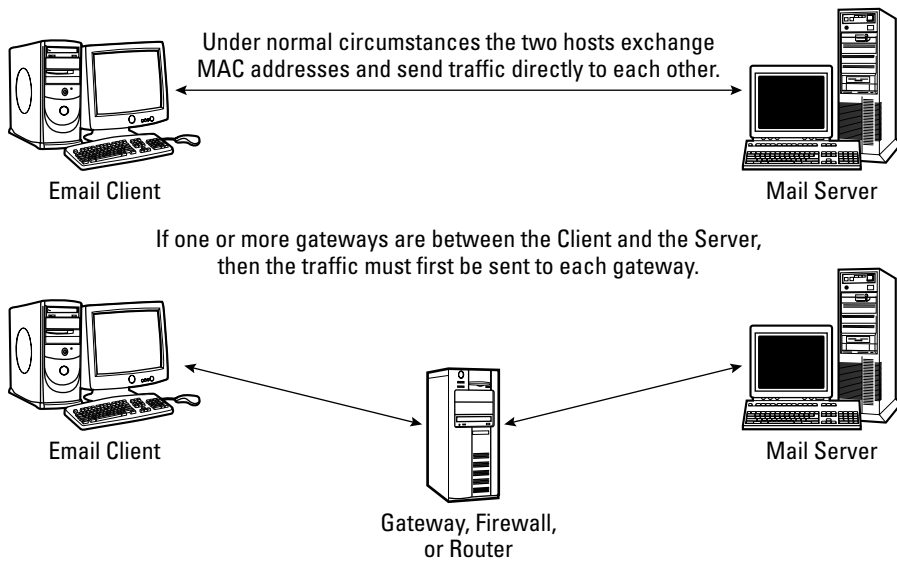
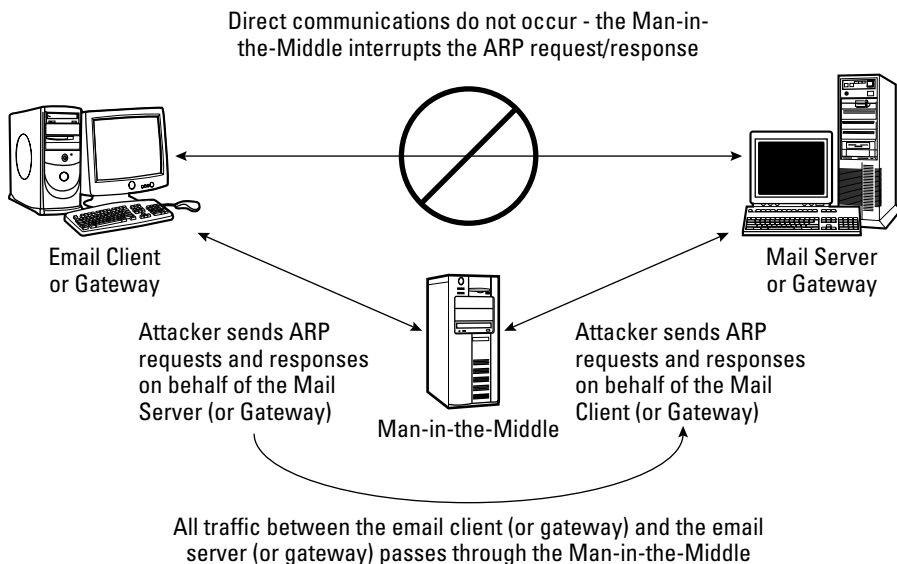

The encryption process using private and public keys is further explained in Chapter 14.

**No Attack****Man-in-the-Middle ARP Spoofing Attack****Figure 8-5:** An ARP spoofing man-in-the-middle attack

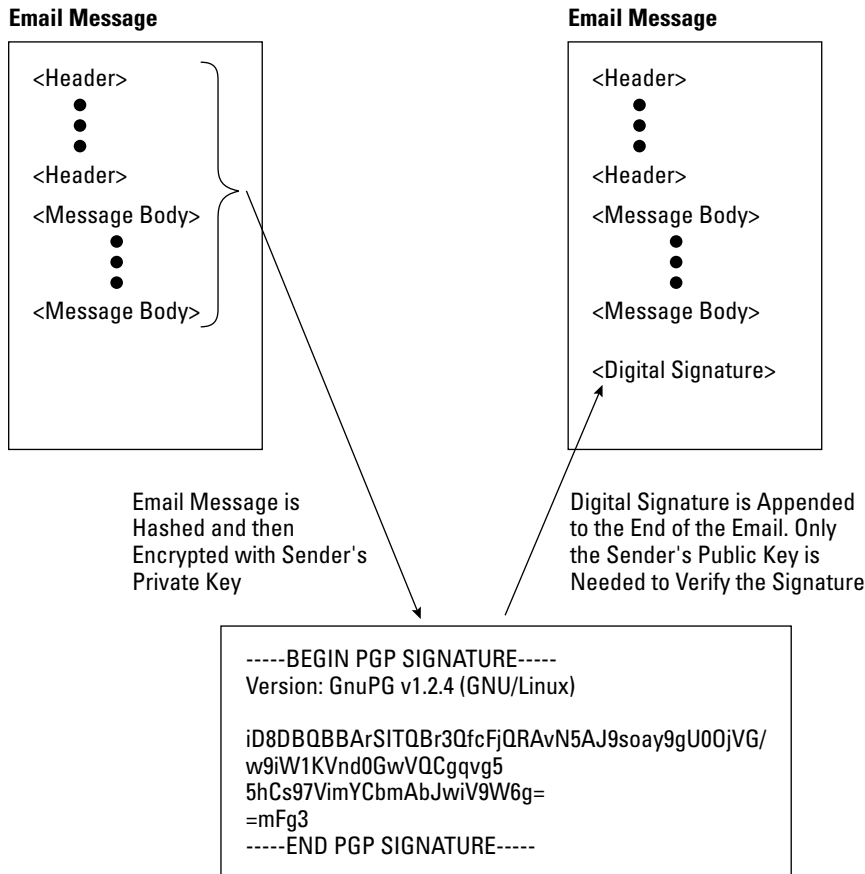

Figure 8-6: Attaching a digital signature to an e-mail

E-mail replay attack

An e-mail replay attack occurs when an e-mail packet (or set of packets) is captured, the e-mail message extracted, and the message put back on the network at a later time (replayed). This causes a second, identical e-mail to be received. The danger or damage occurs when the second e-mail is accepted as legitimate and causes unforeseen consequences.

Replay may be used if an attacker discovers a business that sends financial transactions over e-mail. The attacker then arranges for a nominal transaction (perhaps a \$100 refund). The attacker captures the e-mail authorizing the refund and replays it several times causing several refunds to occur.

In the case of a replay attack, shown in Figure 8-7, the attacker does not have to use the gateway or ARP spoofing. The attacker merely needs to be on one of the many segments that the e-mail packets transverse on their way to or from the mail server.

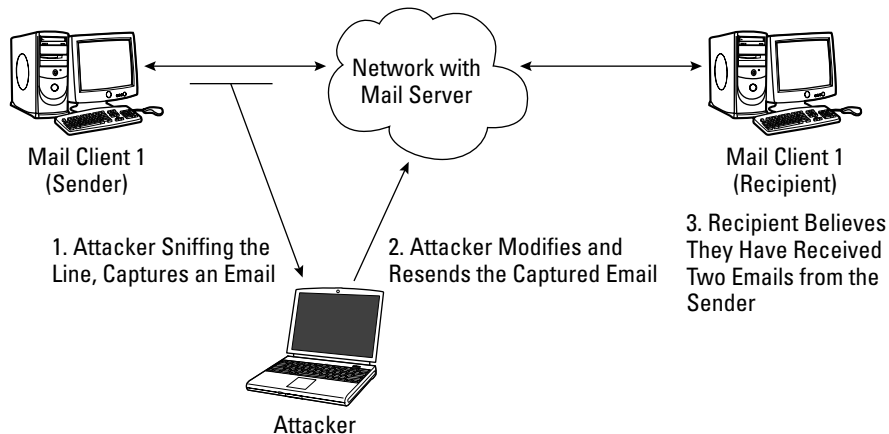

Figure 8-7: Replay attack

The bottom line

This chapter examines some ways to make e-mail more secure (preferred protocols, and so on), some ways to safeguard the transmitted data (encryption, and so on), and some ways to improve authentication. But, in the end, if a user allows a collaboration tool to do things such as launch executables, run scripts or macros, modify databases or files, change systems or register settings, and e-mail other users, these other security measures will be very limited in their success.

Spam

Spam is the unwanted receiving of e-mail. Spam has become a serious problem in today's networking environment. It is a major irritant and consumer of resources. It has been estimated that for some of the large e-mail providers, over half of the e-mail they service is spam. In gross terms, this means that these providers could get by with half of the resources needed to handle their customers' e-mail. From a security perspective, spam is a potential denial-of-services (DoS) problem.

Spammers make money by getting their advertising message out to thousands or millions of people. Very few will respond positively to the message, but even a very small percentage of responses will produce enough activity to make the spamming profitable. Spamming is profitable because it is very cheap to send an e-mail, so it requires only one positive response to cover the cost.

Spammers put their advertising message into the body of the e-mail and view e-mail headers as a necessary encumbrance needed to get the body delivered. Spammers view e-mail headers as a possible Achilles heel that can hurt them. If users and Internet service providers are able to trace the spam back to the source, the spammers could be tied up in legal proceedings or other methods of limiting them. This severely increases the cost of sending out the e-mails and reduces the profit margin to the point that the spammer may not be able to continue to operate.

Spammers take steps to hide their originating (From:) address. This is easily done if spammers run their own e-mail servers. For example, sendmail configuration files can be modified to put in a particular originating address. This address may be either fake (such as yourfriend.spam) or a legitimate address that is not owned by the spammer.

Spam DoS

Spam DoS attacks are a result of spammers using false domains in the e-mails they send. If a spammer does not use a valid domain, the spam can be blocked by testing that the e-mail was sent from a legitimate domain. In this case, a domain is legitimate if it returns a value when a Domain Name Server (DNS) lookup is done.

The following **dig** command does a DNS lookup of an e-mail coming from bob@sytexinc.com:

```

; <<>> DiG 9.2.1 <<>> @198.6.1.2 sytexinc.com
;; global options: printcmd
;; Got answer:
;; ->>HEADER<<- opcode: QUERY, status: NOERROR, id: 44457
;; flags: qr aa rd ra; QUERY: 1, ANSWER: 1, AUTHORITY: 4,
ADDITIONAL: 4

;; QUESTION SECTION:
sytexinc.com.                IN      A

;; ANSWER SECTION:
sytexinc.com.                604800 IN      A      64.124.137.66

;; AUTHORITY SECTION:
sytexinc.com.                84575  IN      NS     ns1.i-n-s.com.
sytexinc.com.                84575  IN      NS     ns2.i-n-s.com.
sytexinc.com.                84575  IN      NS     ns3.i-n-s.com.
sytexinc.com.                84575  IN      NS     ns4.sytexinc.com.

;; ADDITIONAL SECTION:
ns1.i-n-s.com.                84575  IN      A      146.145.146.18
ns2.i-n-s.com.                84575  IN      A      146.145.6.85
ns3.i-n-s.com.                84575  IN      A      146.145.146.19
ns4.sytexinc.com.            84575  IN      A      64.124.137.67

```

```
:: Query time: 1263 msec
:: SERVER: 198.6.1.2#53(198.6.1.2)
:: WHEN: Wed Aug 18 15:15:32 2003
:: MSG SIZE rcvd: 200
```

The most prevalent DoS attack that occurs due to spam is when a spammer forges an address on thousands or millions of mail messages. The result is tens of thousands of bounces, complaints, and a few responses. This results in a flood of email traffic to the forged address, essentially shutting down the address for legitimate use.

Another DoS situation occurs when the spammer forges a valid e-mail address and this address then gets blacklisted. When this occurs, the user of the valid e-mail can experience obstacles to sending legitimate e-mail to users whose Internet service provider uses blacklists.

Blacklisting

A *blacklist* is a database of known Internet addresses (by domain names or IP addresses) used by spammers. Often, Internet service providers and bandwidth providers subscribe to these blacklist databases to filter out spam sent across their network or to their subscribers.

Lists of IP addresses to be added to the blacklist are collected in different ways, including the following:

- ♦ The e-mail user community (all of us) send samples of spam to the blacklist site. The site parses out the offending originating e-mail IP addresses and adds them to the blacklist.
- ♦ The blacklist provider runs its own mail server and fake e-mail user. Any e-mail received is automatically unsolicited and therefore spam.
- ♦ Blacklist providers exchange lists.

Some blacklists are implemented by placing offending IP addresses in a nameserver database. When a spammer's e-mail arrives, a DNS lookup is conducted to verify that the sender's e-mail address is legitimate. However, blacklisted addresses return invalid responses so the server rejects the e-mail.

Spam filters

Spam filters attempt to identify spam from the content of the message body and not the message headers. If spam filtering can be done, it will strike at the heart of the problem and hit spammers in an area that they may not be able to circumvent. Spammers may be unwilling to change the content of an e-mail, which is in essence their advertisement message. If spammers are not able to present the advertisement, they may as well not send the e-mail at all.

Defining Bayesian Logic

According to Bayesian logic, the only way to quantify a situation with an uncertain outcome is through determining its probability. Bayes' Theorem is used to quantify uncertainty based on probability theory. The Bayes' Theorem defines a rule for refining a hypothesis by factoring in additional evidence and background information. This leads to a number that is the degree of probability that the hypothesis is true.

For example, suppose that you have a bag that contains three marbles, each of which may be blue or red. In a blind test, you reach in and pull out a red ball. You return the ball to the basket and try again and again pulling out a red ball. Once more you return the ball to the basket and pull a ball out, red again. You form a hypothesis that all the balls are, in fact, red. Bayes' Theorem can be used to calculate the probability (p) that all the balls are red (an event labeled as A) given (symbolized as I) that all the selections have been red (an event labeled as B):

$$p(A|B) = p\{A + B\}/p\{B\}$$

The possible combinations are RRR, RRB, RBB, and BBB. The possible outcomes are RRR, RRB, RBR, RBB, BRR, BRB, BBR, and BBB. The chance that all the balls are red is $\frac{1}{8}$ (possible combinations) in $\frac{1}{8}$ of all possible outcomes. Therefore, the probability that all the balls in the bag are red, given that all the selections so far have been red, is 0.5 where 0 is no probability and 1 is 100 percent probability.

A spam filter builds on the fact that spam is easily recognized by the recipient of the e-mail. Partially, this is because the recipient has not requested the e-mail, but also because the information contained in the e-mail is not of interest to the user. It is also assumed that a third party would also be able to identify spam. Terms of familiarity such as *Hi*, *re:*, and *your account*, are not likely to fool a third party into thinking the e-mail is legitimate and not spam. The task for a spam filter is to automate the process that is done so easily by the user (or third party). In most cases, spam filtering can be done with statistical analysis and Bayesian logic.

Statistical analysis is done by comparing large sets of normal e-mail and sets of spam. Statistics are then derived that look for combination of words that do not normally occur in legitimate e-mail.

Maintaining e-mail confidentiality

Confidentiality is achieved when a third party cannot read the e-mail sent between the sender and the receiver.

The e-mail traffic itself can be protected against a third party reading the e-mail with the use of encryption. If the third party can (somehow) defeat the protections previously listed and get a copy of the e-mail, he or she would still have to decrypt the e-mail. The following are some factors to consider when determining how effective encryption will be in maintaining the e-mail's confidentiality:

- ♦ If a symmetric key is used, the key is passed securely between the sender and receiver. Hopefully, the key is transmitted in a different manner than the e-mail itself. It would be foolish to e-mail the encryption key and then e-mail an encrypted message. If an attacker can capture the e-mail, they are just as likely to be able to grab the key.
- ♦ If a public-private key encryption method is used, the receiver's private key must be protected and kept secret. With public-private key encryption, only the recipient's private key will be able to open and read the message.
- ♦ Strong encryption methods should be used. If a weak method is used to encrypt the message, the attacker may grab the e-mail and spend a few weeks decrypting the message. Strong encryption methods are Secure Sockets Layer (SSL) using 128 (or more) bits and Pretty Good Privacy (PGP) using 2048 (or more) bit keys.



SSL and PGP are discussed in detail in Chapter 16.

Maintaining e-mail integrity

Integrity is the assurance that an e-mail has not been altered in transmission between the sender and the receiver. In familiar terms, integrity ensures that the receiver gets the message that the sender has sent.

E-mail integrity is ensured with the use of digital signatures. (Digital signatures are described earlier in this chapter in the “Data integrity” section.) E-mail integrity can also be maintained by encrypting the e-mail, because any alteration to the encrypted e-mail will cause the decryption to fail.

Digitally signing e-mails also allows for nonrepudiation. Repudiation occurs when the sender of the e-mail denies having sent the e-mail at a later date. The sender may attempt to claim that the e-mail is a hoax or a forgery. Because only the holder of the private key (the sender) can create the digital signature, the sender of the e-mail will have to accept responsibility for sending the e-mail or claim that their private key was stolen.

E-mail encryption does not allow for nonrepudiation. Because the encryption is done with the receiver's public key, anyone who has access to this key can encrypt the e-mail.

E-mail availability issues

A user's ability to send and receive e-mails determines his availability, which is considered a security issue. If an attacker is able to prevent the use of e-mail, this condition would be considered a DoS attack.

E-mail availability is provided by means that are usually considered outside the scope of the e-mail system (with the possible exception of spam filters). The following are some measures that system and network administrators can generally take to ensure e-mail availability:

- ♦ The use of a spam filter (discussed earlier in this chapter)
- ♦ The use of border protection devices such as firewalls and proxies
- ♦ The use of internal network protection devices such as intrusion detection systems (IDS)
- ♦ The use of host-based intrusion detection systems (HIDS) to protect individual servers and workstations
- ♦ The use of frequent backups, strong passwords, and other good operating procedures

The E-mail Protocols

Several protocols are associated with e-mail, such as SMTP, POP, and Internet Message Access Protocol (IMAP). These are discussed briefly in the following sections.

SMTP

The Simple Mail Transfer Protocol (SMTP) is used for sending e-mail messages between servers. Most systems that send mail over the Internet use SMTP to send messages from one server to another; the messages can then be retrieved with an e-mail client using either POP or IMAP. Figure 8-8 illustrates how e-mail is sent with SMTP and received with POP or IMAP.

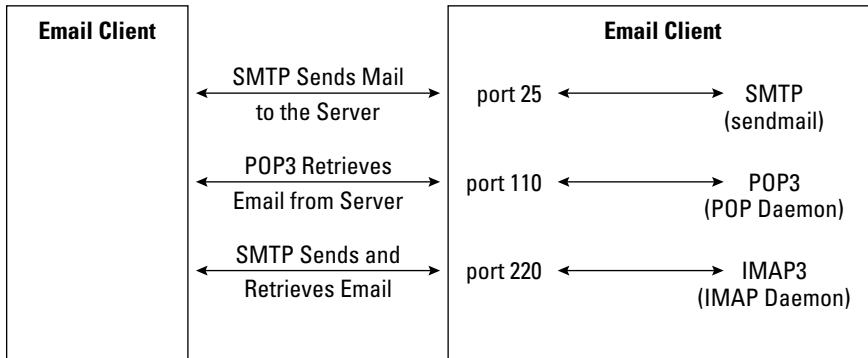

Figure 8-8: Various protocols are used to send and receive e-mail.

The SMTP protocol looks very much like a conversation between the sender and receiver. Figure 8-9 illustrates this conversation. Initially, the client connects on port 25. This is a well-known port that most SMTP servers listen to; however, the server can be configured to use any other port. Changing the port may make the server more secure through obscurity, but it would then not be accessible to receive mail from the general public. This configuration would only be practical on an isolated corporate wide area network (WAN).

After connecting to port 25, the client waits for the server's greeting. In the following example, the commands issued by the client are shown in bold.

```
telnet the-isp.tmp 25
Trying 169.112.72.30...
Connected to the-isp.tmp.
Escape character is '^]'.
220 smtp.the-isp.tmp ESMTP Sendmail 8.12.8/8.12.8; Wed, 18 Aug
2004 14:50:41 -0400
```

The client then sends a HELO command with its domain name and waits for the response, as follows. The commands are shown in all-caps here, although the protocol is not case sensitive. Some servers also support the EHLO command, which requests that the server send more information about commands that are available at each step in the conversation. Some mail servers require that the client accurately report their domain; other servers accept any domain name. Reporting a fabricated domain name may be a means for spammers and attackers to hide their tracks.

```
HELO johnbrown
```

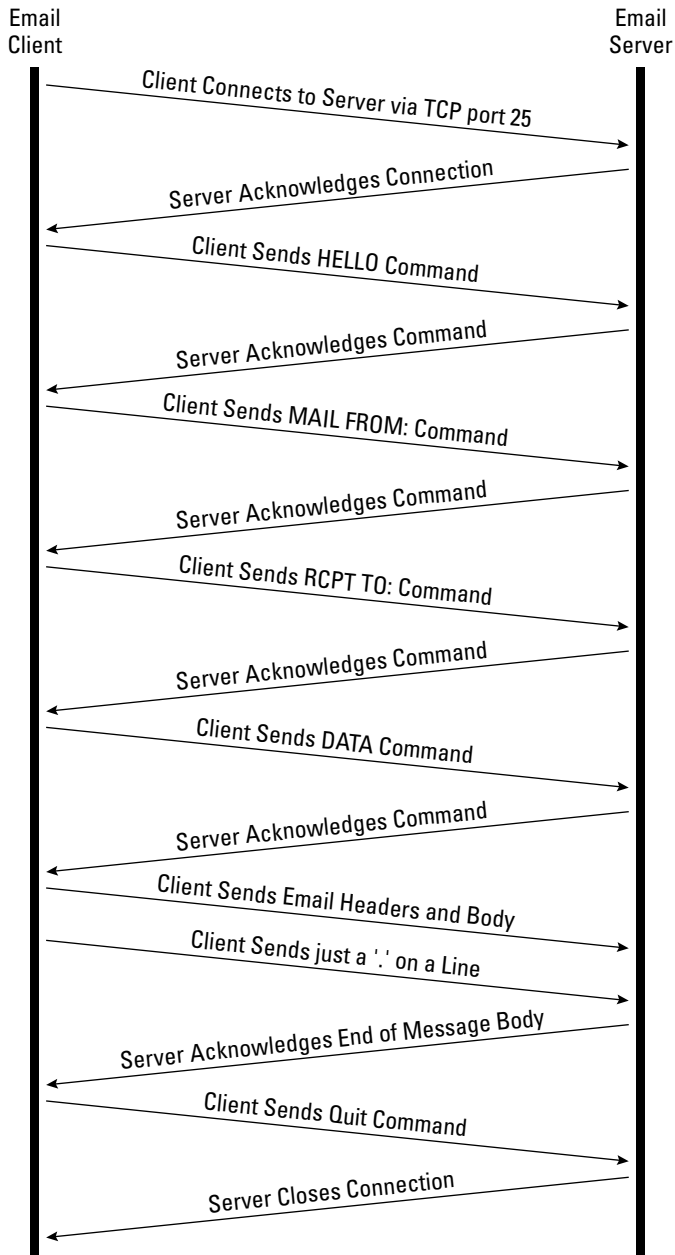



Figure 8-9: A typical SMTP conversation

The SMTP server responds with the domain name of the client as the server recognizes the client. This need not be the same domain name as the client has sent in the HELO command.

```
250 smtp.the-isp.tmp Hello [112.218.183.8], pleased to meet you
```

The client then sends a MAIL FROM: command providing the sender's address, and waits for the response:

```
MAIL FROM: billy-joe@research.tmp
250 2.1.0 billy-joe@research.tmp... Sender ok
```

The client now sends one RCPT TO: command for each recipient address. The server must acknowledge each command before the client can continue.

```
RCPT TO: mom@research.tmp
250 2.1.5 mom@research.tmp... Recipient ok
```

The e-mail message can now be transmitted. Both message headers and body are part of the data command in the SMTP protocol. The data entry continues until a period (.) followed by a carriage return is entered on a newline, as follows:

```
DATA
354 Enter mail, end with "." on a line by itself
Subject: Hi Mom!
How are you?
Please send money!

Love,
your son - jb
.
250 2.0.0 i7IIofM0001724 Message accepted for delivery
```

Note that all of the header data need not be true. The SMTP protocol treats the Date, From, and To header lines as user-defined data. There is no requirement that these be valid. Spammers will usually put in false header data to avoid detection.

The telnet and SMTP session is now closed with the quit command. If the client has more than one message to transmit, rset command is sent and then followed with a new MAIL, RCPT, and so on. After all messages have been transmitted, the quit command is sent:

```
QUIT
221 2.0.0 smtp.research.tmp closing connection
Connection closed by foreign host.
```

POP

The Post Office Protocol (POP) is used to retrieve e-mail from a mail server. POP3 is the most recent version of the protocol and is available in all popular mail clients. POP3 is intended for users to download their e-mail from a mail server on which they have an account or mailbox. Most e-mail clients have a default behavior of deleting the mail on the server after it is downloaded. POP3 does not support sending e-mail.

POP3 is by far the most common protocol used by nontechnical Internet users. It should, therefore, be closely watched for the security concerns that it raises. POP3 uses a client-server model in which the client connects to the server and issues simple text commands, and the server responds. Basic POP3 does not support encryption, so both passwords and the e-mail content are transmitted in the clear (unencrypted). Clients and servers may offer enhanced authentication and encryption that can be used with POP3 to alleviate the security concerns.

To authenticate using the USER and PASS command combination, the client must first issue the USER command. If the POP3 server responds with a positive status indicator (+OK), the client may issue either the PASS command to complete the authentication, or the QUIT command to terminate the POP3 session. If the POP3 server responds with a negative status indicator (-ERR) to the USER command, the client may either issue a new authentication command or the QUIT command. The following is a POP3 session that was initiated with telnet from a command prompt. The commands issued by the client are in bold and the passing of user names and passwords in the clear is transparent:

```
telnet pop.the-isp.tmp 110
Trying 163.67.114.17...
Connected to pop.the-isp.tmp.
Escape character is '^]'.
+OK Messaging Multiplexor (iPlanet Messaging Server 5.2 HotFix 1.21 (built Sep
8 2003))
USER jim-bob
+OK password required for user jim-bob
PASS sad2say
+OK Maildrop ready
LIST
+OK scan listing follows
1 2059
.
RETR 1
+OK 2059 octets
Return-path: <jim-bob@sytexinc.com>
Received: from dedicated199-bos.wh.ip.net ([10.228.166.89])
by cluster02-bos.wh.ip.net
(iPlanet Messaging Server 5.2 HotFix 1.21 (built Sep 8 2003))
with ESMTPL id <0I2N00LHYMLUAL@cluster02-bos.wh.sprintip.net> for
```

```
jim-bob@the-isp.tmp; Wed, 18 Aug 2004 18:13:06 +0000 (GMT)
  <multiple Received: lines deleted>
Date: Wed, 18 Aug 2003 14:14:20 -0400
From: Jim Bob <jim-bob@atrc.sytexinc.com>
Subject: Hi mom
To: jim-bob@the-isp.tmp
Reply-to: jim-bob@atrc.sytexinc.com
Message-id: <1092852860.10112.4.camel@compaq.research.tmp>
MIME-version: 1.0
Content-type: text/plain
Content-transfer-encoding: 7BIT
Original-recipient: rfc822; jim-bob@the-isp.tmp
```

Please send money!

Love jim-bob

```
.
DELE 1
+OK message deleted
QUIT
+OK
Connection closed by foreign host.
```

IMAP

The Internet Message Access Protocol (IMAP) is a method of accessing e-mail on a remote server. It was designed for use where the e-mail will stay on the remote server, and the user may access the e-mail from more than one client. In this way, the user can be mobile and still have access to all the new and old e-mails. IMAP supports capabilities for retaining e-mail and organizing it in folders on the server. IMAP is often used as a remote file server.

IMAP offers features similar to POP3 with some additions that improve the efficiency for the user and improve their performance over low-bandwidth lines. IMAP has some search capabilities so users do not have to download all their messages to find the critical ones. The structure or outline of a message can also be read without the need for the client to download the entire message. If the user chooses to read the message, the entire e-mail (or just part of it) can be downloaded. Some of the features of IMAP offered by the standards are as follows:

- ♦ Access to multiple mailboxes on multiple servers
- ♦ Support for folder hierarchies
- ♦ Standard and user-defined message flags
- ♦ Shared access to folders by multiple users

- ♦ Message searching and selection
- ♦ Selective access to MIME body parts
- ♦ Provision for protocol extensibility through annotations

These features clearly support users who need to access their e-mails from multiple locations and clients and have a need to store the messages for later recall and manipulation.

E-mail Authentication

Proper authentication is also a security concern. Sometimes authentication is considered a confidentiality issue (for the e-mail receiver) or an integrity issue (for the e-mail sender). E-mail authentication is generally part of the e-mail protocol used. This section discusses several methods for authenticating e-mail.

Plain login

In the plain authentication method, the user name and password are converted into a base64 encoded string. Base64 encoding was described earlier in Figure 8-1 and in the “Attacks involving malcode” section. In the following example, the application `mimencode` is used to convert the three NULL-terminated strings of `user`, `myUserName`, and `mySecretPassword` into one base64 string. This results in a string of `dXN1clwxbX1Vc2VyTmFtZVwubX1TZWNyZXRQYXNzd29yZAo=`.

```
echo "user\0myUserName\0mySecretPassword" | mimencode  
  
dXN1clwxbX1Vc2VyTmFtZVwubX1TZWNyZXRQYXNzd29yZAo=
```

Manually telneting into a server and issuing the following commands demonstrates the plain authentication process.

```
telnet email.sytexinc.com 25  
Trying 192.168.1.25  
Connected to 192.168.1.25  
Escape character is '^]'.  
HELO test  
auth plain dXN1clwxbX1Vc2VyTmFtZVwubX1TZWNyZXRQYXNzd29yZAo=  
235 Authentication successful
```

Note that the mail server responded with “Authentication Successful,” indicating that the user name and password were accepted as proper authentication.

Although the user name and password are not human readable during the telnet transaction, this is not a secure way to transmit a password. Anyone sniffing the packets would have no difficulty in identifying the protocol and authentication method. They could then easily extract and decode the password.

Login authentication

Login authentication is similar to plain authentication, with the user name and password being passed separately. The following example shows the user name and password being encoded with base64. The user name and password are then used to authenticate to the mail server. The lines in bold are entered on the command line.

```
# echo "myUserName" | mimecode
bX1Vc2VyTmFtZQo=
# echo "mySecretPassword" | mimecode
bX1TZWNyZXRQYXNzd29yZAo=
```

The following manual telnet session demonstrates the login authentication. The lines in bold are entered by the e-mail client.

```
# telnet email.sytexinc.com 25
Trying 192.168.1.25
Connected to 192.168.1.25
Escape character is '^]'.
HELO test
auth login
334 VXN1cm5hbWU6Cg
bX1Vc2VyTmFtZQo=
334 UGFzc3dvcmQ6
bX1TZWNyZXRQYXNzd29yZAo=
235 Authentication successful
```

Note that the mail server provided prompts of “Username:” and “Password:” that are base64 encoded as VXN1cm5hbWU6Cg and UGFzc3dvcmQ6, respectively.

As with plain text authentication, this is not a secure method of transmitting the user’s password. The protocol and authentication method are easily identified and the password extracted and decoded.

APOP

Authenticated Post Office Protocol (APOP) encrypts the user’s password during a POP session. The password is encrypted by using a secret that the user provides to the server long before the APOP session.

The strength of this encryption depends on a number of factors, including the following:

- ♦ **The complexity of the secret**— The more complex the secret, the better the encryption.
- ♦ **How often the same secret is used**— Over time, the encryption can be broken if the secret is not changed.

To assign the secret on the mail server, the user logs in to the server and issues the `popauth` command. The user is then prompted for the secret key. Later, when the user attempts to retrieve e-mail with an e-mail client, the same secret key is provided to the client so that the user's password can be encrypted.

There are three security concerns when using APOP:

- ♦ The password used is not the same as the user login; therefore, a separate file must be used to keep this password. This becomes another point of failure and possible way to exploit.
- ♦ Not all clients support APOP. This may lead organizations to settle for a more universal, although less safe method of authentication, such as the basic user name and password used by POP3.
- ♦ APOP is concerned only with encrypting the user name and password and does not encrypt the e-mail messages itself.

NTLM/SPA

The NT LanManager (NTLM) protocol, also known as Secure Password Authentication (SPA), is a Microsoft-proprietary protocol that operates via the SMTP AUTH interface defined by RFC 2554. This authentication is provided by Microsoft mail for its mail servers and clients as a secure means of authenticating POP3, SMTP, and IMAP traffic.

The NTLM/SPA authentication exchange consists of three messages, as described in the following scenario:

1. The client (either Outlook or Outlook Express) sends the authentication method to be used and the server responds.

```
AUTH NTLM
+OK NTLM
```

2. Now the first authentication message is sent by the client to identify itself to the server. This is message type 1; it indicates the version of Outlook.

```
T1RMTVNTUAABAAABoI<message 1>
```

3. The second authentication message is the server's challenge. This message contains a string of 8 bytes called the *nonce*. The client will encrypt the nonce with the user's password and send it back to the server.

```
+ T1RMTVNTUAAABAAAAA4I<message 2>
```

4. Finally, the client responds with the third authentication message. This identifies the user, domain, and host name. The nonce sent in the server's challenge is encrypted with the user's password and returned in this message. The server repeats the encryption process with the stored password for the user and, if the response strings match, authentication is complete. The server then acknowledges that the user has authenticated.

```
T1RMTVNTUAADAAAAGAA<message 3>
```

+OK logged onPOP before SMTP

The POP before SMTP authentication method provides a means for preventing spammers from using a mail server for relaying, while providing plenty of flexibility for users that change locations frequently.

Mail relaying is when a mail server in domain A is used to send mail between domains B and C. Mail servers that permit relaying are abused by spammers who want to cover their tracks by not using their own mail servers to send mail. If a spammer were to use his or her own mail server, the Internet community would quickly block and isolate the spammer's domain.

Many organizations need to provide mail-sending capability for users that access the mail server from different (and changing) domains. Consider a mobile sales force that must send frequent e-mail but is constantly on the road connecting from different service providers. In such a case, the mail server must permit the relaying of mail for the authorized users, while at the same time preventing spammers from relaying mail. The POP before SMTP authentication method provides a solution for this problem.

In a nutshell, SMTP relaying is permitted by an IP address if that IP address has participated in a valid POP session in the prior x minutes. (The value of x varies for each server but is typically 15 minutes to one day.) The POP protocol requires a valid password so spammers will not be able to use POP prior to using the mail server for relaying. Therefore, only authorized users will be able to use the mail server for mail relaying.

Kerberos and GSSAPI

Kerberos is a network authentication protocol designed to provide strong authentication for client/server applications by using secret-key cryptography. Kerberos

authenticates the client application to the server application. A token is used to authenticate the client. The client first obtains the token from a third-party server (the token server). For the client to get the token, it must pass a strong authentication process.



Kerberos is discussed in more detail in Chapter 16.

The Generic Security Services Application Programming Interface (GSSAPI) is an attempt to establish a generic Application Programming Interface (API) for client-server authentication. Typically, each application has its own authentication methods. By developing and using a common API, the overall security can be improved by the increased attention paid to its implementation and testing. GSSAPI is similar to Kerberos in that a token is passed between the mail client and server. The underlying mechanism is based on public-private key encryption technology.

Operating Safely When Using E-mail

In addition to the protections provided by the various protocols and encryption methods, a user must also operate safely when using e-mail to avoid security problems. The following sections provide recommended safe operating procedures.

Be paranoid

You can avoid most e-mail-propagated malcode attacks by properly using your e-mail. The following list outlines some steps that a paranoid user will use to keep safe and secure:

- ♦ **Keep your e-mail address private.** Avoid providing it whenever possible on Web sites and other interactive forums such as chat rooms.
- ♦ **Set up one or more sacrificial e-mail addresses.** When an e-mail address must be provided to a Web site, the user should have a sacrificial e-mail address to use. When an e-mail is received on this account the user knows that there is a high likelihood that it will be spam or malicious in nature. The user must resist the temptation to browse through the e-mails received on this account.
- ♦ **Keep e-mail for different organizations separate.** In most cases, this will mean one account for work and a separate account for home. The ramifications of receiving and propagating malicious code in a work environment may be more damaging than at home.

- ♦ **Do not open any e-mail that is not expected.** Common sense can be a strong deterrent to the spread of malicious code. An unexpected “Read This” or “Try This Game” should be ignored until the user can verify what the sender has in mind. The verification can be in person, by phone, or by a second e-mail (initiated from the user).
- ♦ **Never save or open attachments from strangers.** All curiosity must be resisted.
- ♦ **Never save or open attachments that are not absolutely needed.** The fact that a friend wants to send a user an attachment does not obligate the user to open it. Some users would be surprised to find how easily life proceeds without opening risky e-mails and attachments. If it is really important or of special interest, the friend will follow up and explain what is in the attachment.

Mail client configurations

Microsoft Outlook uses security zones to allow users to customize whether scripts and active content can be run in HTML messages. Outlook provides two choices for the security zone setting: Internet or Restricted.



More detail on the Internet Explorer security zones is provided in Chapter 6.

Scripting capabilities of the e-mail clients should be disabled whenever possible. As discussed earlier, if scripts are executed by the e-mail client, the user will be vulnerable to worms and viruses. If scripts must be passed around, they should be saved to a file and examined before being executed.

Mail clients should not use the Preview feature when viewing e-mail. Many e-mail clients will provide a feature to preview the currently selected (highlighted) e-mail on the list of e-mails. This is usually done in a split window, which simultaneously shows the list of received e-mails in one half of the window while the currently selected e-mail can be read in the other half of the window. The Preview feature can be a risk for two reasons. First, depending on the client settings, when an e-mail is opened for display, scripts may be run. Even if the user is aware that a virus is propagating and the user would avoid opening the e-mail, the Preview feature might inadvertently open it.

Another reason for not using the preview feature is that an e-mail may have a flaw in the mime encoding. Some flaws can cause the client to hang or crash the mail client when the e-mail is opened for reading. If it happens that such a malformed e-mail is at the top of the list of e-mails, the Preview feature will attempt to open this e-mail. As a result, the e-mail client will become unusable because each time the client is launched, the Preview feature opens the malformed e-mail and the client crashes immediately.

Application versions

It is important to stay current with revisions and updates to mail client-server software. SMTP mail servers are high-visibility targets of hackers. This susceptibility is demonstrated in the history of vulnerabilities and subsequent fixes that have evolved over the years for the most popular mail server, sendmail. It was not uncommon to see a new version of sendmail every three months. The pace has slowed in recent years, but new versions are still released every 12 months or so.

You should stay current with the new releases of a mail server. When a new vulnerability or exploit is discovered, a corresponding mail server fix will quickly follow. It is important that all mail servers be upgraded to the new release. Attackers of mail servers will seek the path of least resistance. They will seek out old versions of the mail server application and focus their attacks on these servers.

Network administrators should check the CERT Coordination Center (CERT/CC) at www.cert.org for alerts and summaries to ensure that they are running the latest recommended version of their mail server. If the mail server that is being used is not listed by CERT/CC, the network administrators should check with the mail server vendor for the latest recommended release.

When downloading a new version of an SMTP application, it is important to verify the download site (download only from sites with valid certificates) and verify the PGP or MD5 signature of the download. There have been attacks in the past where bad (vulnerable) versions of sendmail have been circulated over the Internet. Network administrators, believing they were protecting themselves, inadvertently downloaded and installed vulnerable versions of sendmail.

Architectural considerations

A number of system and network-related architectural considerations ensure safe use of e-mail:

- ♦ **Check for viruses.** Every workstation or server should run virus protection.
- ♦ **Use a mail relay or mail proxy.** Medium- to large-size organizations benefit from having all their mail received first by a mail relay or mail proxy. The mail relay will usually sit in the DMZ outside the perimeter firewall. If configured properly, the relay can check for unwanted scripts, viruses, and questionable attachments. Mail relays are also a good place to put spam protection, such as blacklist monitoring and spam filtering.
- ♦ **Buffer against attacks.** If possible, risky activity should be undertaken on workstations that can better afford to be attacked. Generally, this would be a workstation that has little or no personal and sensitive data. This workstation should also not contain critical applications that can't be lost or re-installed. It should be expected that a workstation that is buffering this way may have to be rebuilt every 3 to 6 months.

- ♦ **Back up frequently.** Even the best security measures will occasionally fail to stop a new and emerging threat. To minimize the impact, when that happens, backups should be done frequently. The frequency of backups depends on the level of critical data involved. A book author will back up a few times a day, while the typical home user may get by with backing up once a week or once a month.
- ♦ **Control scripting capabilities.** Some mail client will provide collaboration capability and run scripts automatically. Usually, this feature can be disabled to reduce the risk worm and virus attacks.
- ♦ **Limit attachments.** Attachments can contain scripts and executable code. When the user runs these scripts or executables, they will have all the privileges and access that the user enjoys. Unless the user is diligent and fully appreciates the risk, it is not safe to allow attachments on e-mail.
- ♦ **Quarantine attachments.** In many cases, an organization can benefit from quarantining attachments. This is done by a mail relay or mail proxy that strips attachments off of e-mails before they are delivered to users. If the user can assert the need for the attachment and verify that it has been sent by a legitimate sender, they can recover that attachment.

SSH tunnel

Creating a secure tunnel for using less secure e-mail protocols can be a strong method of protecting the privacy and integrity of the e-mail. Secure Shell (SSH) is a program for logging into a remote machine. SSH allows for executing commands on a remote machine and is intended to replace rlogin and rsh. SSH provides secure, encrypted communications between two untrusted hosts over an insecure network.

With SSH, TCP/IP ports can be forwarded over the secure channel (through the tunnel). Normally, the SSH client connects to the server over port 22. Consider the following commands (client commands are in bold):

```
ssh 192.168.1.2
jim-bob@192.168.1.2's password:shh!secret
Last login: Sat Aug 21 11:58:33 2003 from 172.16.1.3
[jim-bob@192.168.1.2]#
```

The SSH client (`ssh`) attempts to connect to the server `192.168.1.2` on port 22. The client and server exchange encryption keys and then the client is prompted for a password on the server. It is important to note that the password exchange is done under the umbrella of the encryption; therefore, the password is not vulnerable to sniffing. Once the client has been authenticated, the user gets a window with a command line prompt for entering commands on the server. Everything that the user types and receives in this window is encrypted.

Within this command line prompt window, the user can read and send mail on the mail server. For reading e-mail, the user can use a text-based client, such as elm or pine. The user can also read the e-mail directly from the mailbox, as follows:

```
[jim-bob@192.168.1.2]# cat /var/spool/mail/jim-bob
Return-path: <tmp@the-isp.tmp>
Received: from my.ip.net ([10.228.166.89]) by
        cl.ip.net (Server 5.2 HotFix 1.21
        (built Sep  8 2003)) with ESMTP id
        <0I1X008AF926WC@cluster02.ip.net> for
        tmp@the-isp.tmp; Wed, 04 Aug 2004 12:22:54 +0000
Date: Wed, 04 Aug 2003 12:21:55 +0000 (GMT)
From: tmp@the-isp.tmp
Subject: Send you money!
Message-id: <0I1X001GF8Z03G@boded0199s.ip.net>
Content-transfer-encoding: 7BIT
Mime-Version: 1.0
```

Hi,

Jim-bob, I sent your money

Love, Your Mom

Mail can be sent in the command line prompt window using the **mail** command, which invokes sendmail directly, as follows:

```
[jim-bob@192.168.1.2]# mail -s "Thanks Mom" momma@my-isp.tmp
Thanks again, Mom!
Love,
  Your son
.
cc:

[jim-bob@192.168.1.2]#
```

While a user can accomplish the sending and receiving of e-mail in a command line prompt window during an SSH connection, it is less than optimal. Most users will want to use their favorite e-mail clients. With an SSH tunnel, the user can still have the protection of the SSH encryption, while using their favorite client applications. Figure 8-10 illustrates an SSH tunnel. The following steps are involved in setting up an SSH Tunnel:

1. Establish the SSH session.
2. Configure the e-mail client.

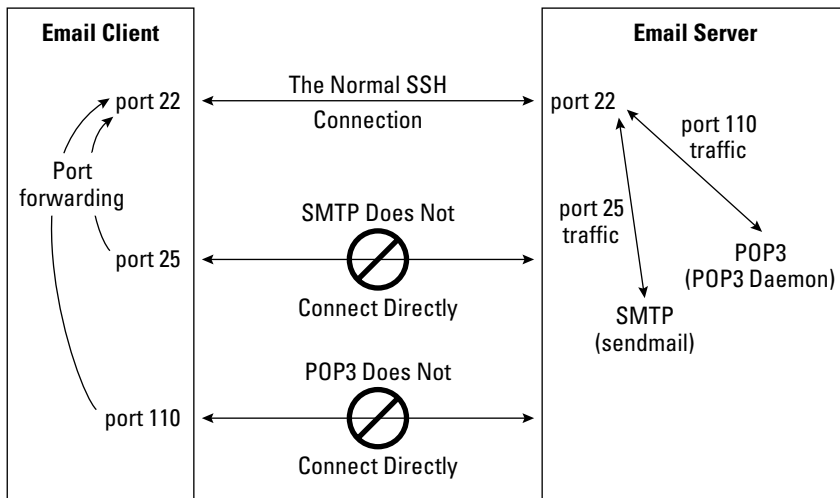

Figure 8-10: An SSH tunnel to secure e-mail

Establish SSH session

An SSH connection to the mail server is established in a similar manner to that described earlier. This will, again, result in a command line prompt window, which will not be used in this case. This can be done with a Windows application, such as putty or on a command line, as follows:

```
ssh mail.sytexinc.com
```

When establishing the SSH session, forward ports from the client to the server. In this case, the client's port 110 (POP3) is forwarded to the server's port 110 for receiving e-mail. Also, the client's port 25 (SMTP) is forwarded to the server's port 25 for sending e-mail. The syntax for designating this port forwarding is as follows:

```
ssh -L 110:mail.iwc.sytexinc.com:110 \
-L 25:mail.iwc.sytexinc.com:25 \
mail.iwc.sytexinc.com
```

The syntax tells the SSH application to forward the local port (-L) of 110 to mail.iwc.sytexinc.com:110.

Configure e-mail clients

Once the SSH session is established, the user's e-mail client can be configured to send and receive e-mail to use the SSH tunnel. To do this, the e-mail client should use the POP protocol to acquire e-mail from the user's local port 110, instead of the

mail server's port 110. In the same manner, the user's e-mail client should be configured to send mail to the local port 25, instead of the mail server's port 25. Note that on e-mail clients, it is often the case that the user does not set the port numbers, rather they choose the protocol of POP and SMTP and the ports are defaulted to 110 and 25, respectively.

Once the e-mail client is configured, the user can receive from (POP) and send to (SMTP) the mail server. The processes are secure, because the traffic passes through the SSH tunnel.

SSH advantages and disadvantages

The advantage of the SSH tunnel is having a secure, end-to-end connection to the mail server over which all mail traffic is sent and received. This compensates for the use of insecure protocols, such as POP3 and SMTP, both of which are easily intercepted (sniffed) and passwords read.

Another advantage of SSH tunneling is the ability to use the two most supported protocols for e-mail (POP3 and SMTP). All e-mail clients and servers support these protocols. Because SSH has been ported to all platforms, there should be no barrier to an organization setting up an SSH tunnel as the means for remote users to access sensitive e-mail.

Following are some of the disadvantages or considerations when using an SSH tunnel:

- ♦ **The SSH session must be established prior to receiving or sending mail.** Most users are accustomed to having instant access to e-mail, without the need to establish a prior connection. Most users will probably bring up the SSH session and leave it up as long as they are on the workstation.
- ♦ **SSH sessions may time out and close, causing the user to fail to send or receive e-mail.** Depending on the sophistication of the user, this could require some user training to check and re-establish the SSH session.
- ♦ **While SSH is ported to all platforms, the SSH application does not come installed out of the box on many systems.** Therefore, the system administrators or users have the extra task of finding and installing an SSH client.
- ♦ **The SSH daemon may not be part of the default mail server installation.** Network or system administrators may have to install and configure the SSH server-side daemon on the mail server.
- ♦ **SSH tunneling provides a secure send and receive method between the client and server.** However, this may not extend all the way to the other end of the total e-mail path—the other email user (see Figure 8-11).

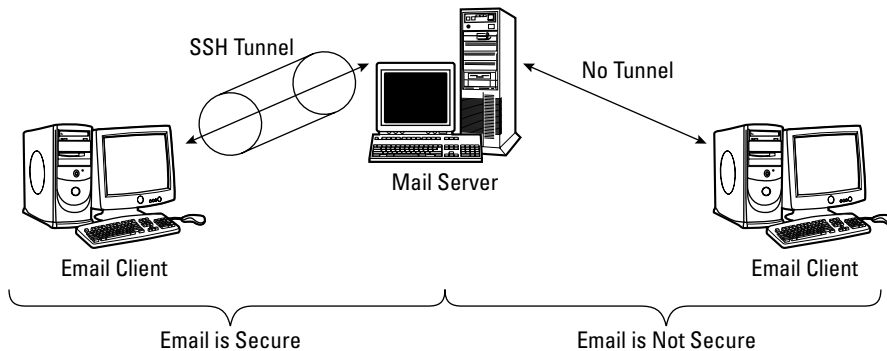

Figure 8-11: An SSH tunnel secures one-half of the e-mail transmission.

PGP and GPG

Pretty Good Privacy (PGP) and GNU Privacy Guard (GPG) are public-private key encryption technologies that can enhance the security of many applications, including e-mail. GPG and PGP are compatible because new releases will be implemented on the OpenPGP standard.

PGP is probably the most popular cryptographic application in the computer community. PGP is an application developed by Phil R. Zimmermann that allows you to communicate in a secure way over an insecure channel. Using PGP, the privacy of data can be protected with encryption so that only intended individuals can read it. PGP is based on public key cryptography: two complementary keys, called a key pair, are used to maintain secure communications. One of the keys is designated as a private key to which only you have access, and the other is a public key, which you freely exchange with other PGP users. Both your private and your public keys are stored in keyring files.

GPG is the open-source equivalent of PGP and is compliant with the proposed OpenPGP Internet standard, as described in RFC 2440. Some of the uses of PGP/GPG are as follows:

- ♦ **Encrypt files for transmission or storage on a hard drive.** The e-mail message can be put into a file, encrypted, and then attached to an e-mail.
- ♦ **Encrypt data for transmission with other protocols such as POP3.** PGP and GPG integrate with the mail clients to encrypt the data.
- ♦ **Create digital signatures of e-mail messages.** PGP and GPG integrate with the mail clients to sign the e-mail message.

Summary

E-mail (along with Web browsing) is one of the most popular uses of the Internet. But for all of its widespread use, e-mail is very insecure. This insecurity comes about mostly because of two factors:

- ♦ A lot of sensitive and private data is sent via e-mail. The potential loss or damage due to a security incident can be considerable in terms of dollars (lost work) or prestige (embarrassment).
- ♦ E-mail started out and is still mostly today sent in the clear (unencrypted). This is of particular concern because it is relatively simple for a technical person to sniff (intercept) e-mail traffic on a network.

There are a number methods to improve the security of e-mail, such as using the more secure protocols that will encrypt the mail traffic.



Domain Name System

When the Internet first began and was known as ARPANET, it was a small community of universally known IP addresses. As it grew to the bustling size of a few hundred hosts, it was determined that memorizing and identifying servers by numbers was difficult and inefficient. Because numbers are more difficult for humans to remember, names were developed for servers. So instead of 15.5.5.5 you could say wiley.com. However, there needed to be a way to link the IP address to a domain name.

To diminish this burden, a flat text file, `hosts.txt`, was created, which contained a listing of server IP addresses and descriptive host names. The following is a sample of what this would look like:

```
15.5.5.1    Eric
15.5.5.2    Server
```

Now if someone wanted to use telnet to connect to the system, they could type either **telnet 15.5.5.1** or **telnet Eric** and it would work.

This file was maintained on a single server by the Network Information Center (NIC) of Stanford Research Institute (SRI). Each administrator was responsible for maintaining an up-to-date copy from the central server on their own host.

This system posed many limitations, including restrictions on domain name selection, inaccuracy, and inefficiency for participating administrators.

As a result, in 1984 Paul Mockapetris of the University of Southern California's Information Sciences Institute developed a design for a more efficient distributed translation method. His suggested architecture was released in RFCs 882 and 883 and became the foundation for the domain name system (DNS) used today.



In This Chapter

Understanding the role of DNS

Identifying common DNS security weaknesses and attacks

Explanation of single-server, split, and split-split DNS designs

Building a DNS architecture



Purpose of DNS

A DNS is composed of name servers, resolvers, and their communications protocol. Together they create a distributed Internet directory service capable of translating between IP addresses and host domain names.

Nearly all Internet services today rely on DNS to function, and without this translation mechanism they cannot operate.

Without DNS, you would enter `http://216.239.39.99` into your Web browser instead of `http://www.google.com`, you would send e-mail to `sring@63.148.66.186` instead of `ecole@testsystem.com`, and you would have to configure your instant message chat client to know that America Online is at `64.12.30.216`. Essentially, the Internet can still function without DNS; but it would mean you would have to remember numbers instead of names. If you know a company is called Wiley, you can make a good guess at what its domain name might be, but you would have no idea what their IP address is.

IP addresses alone are difficult to remember. DNS provides a means of translating addresses into names (and vice versa) that can be descriptive and representative of a site and its purpose/contents.

As shown in Figure 9-1, reading from left to right, a fully qualified domain name is composed of a server, optional subdomains, an organizational domain, and a top-level domain.

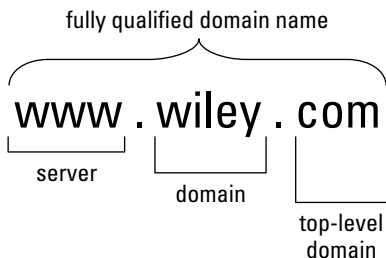

Figure 9-1: Fully qualified domain name structure

Top-level domains are shared across organizations and examples include `.com`, `.mil`, `.edu`, and `.org`. Domain names are registered by organizations through providers such as Network Solutions and Register.com. They are generally not shared across organizations and are descriptive of the information provided within the domain. When subdomains are used, fully qualified domain names are similar to the names in Figure 9-2.



Figure 9-2: Fully qualified domain names including subdomains

Subdomains provide the ability to further categorize a site. However, they require the user to remember and type additional information, and are therefore infrequently used.

Note

On October 25, 2001, the United States Patent and Trademark office awarded patent application number 20010034657 titled "Method and apparatus for conducting domain name service" to Ideafood, Inc. According to this application, Ideafood has patented the idea of assigning users sub-domains, such as `client.hostingcompany.com`.

Top-level domain names were initially broken down by organization type, such as `gov` for government, `edu` for education, and `com` for commercial. However, as the Internet became a global network, people wanted to be able to distinguish by country. In addition, countries that came late to the game noticed all of the good names were used up. Now if you reside in Andoria and your company is named Wiley, because `wiley.com` is taken, you could register `wiley.an`. Table 9-1 lists the high-level domain names based on country.

Table 9-1
Top-Level Domains from Around the World

<i>Domain</i>	<i>Country</i>	<i>Domain</i>	<i>Country</i>	<i>Domain</i>	<i>Country</i>
ad	Andorra, Principality of	gm	Gambia	nr	Nauru
ae	United Arab Emirates	gn	Guinea	nt	Neutral Zone
af	Afghanistan, Islamic State of	gov	USA Government	nu	Niue
ag	Antigua and Barbuda	gp	Guadeloupe (French)	nz	New Zealand
ai	Anguilla	gq	Equatorial Guinea	om	Oman
al	Albania	gr	Greece	org	Non-Profit Making Organizations (sic)

Continued

Table 9-1 (continued)

Domain	Country	Domain	Country	Domain	Country
am	Armenia	gs	S. Georgia & S. Sandwich Isls.	pa	Panama
an	Netherlands Antilles	gt	Guatemala	pe	Peru
ao	Angola	gu	Guam (USA)	pf	Polynesia (French)
aq	Antarctica	gw	Guinea Bissau	pg	Papua New Guinea
ar	Argentina	gy	Guyana	ph	Philippines
arpa	Old style Arpanet	hk	Hong Kong	pk	Pakistan
as	American Samoa	hm	Heard and McDonald Islands	pl	Poland
at	Austria	hn	Honduras	pm	Saint Pierre and Miquelon
au	Australia	hr	Croatia	pn	Pitcairn Island
aw	Aruba	ht	Haiti	pr	Puerto Rico
az	Azerbaijan	hu	Hungary	pt	Portugal
ba	Bosnia-Herzegovina	id	Indonesia	pw	Palau
bb	Barbados	ie	Ireland	py	Paraguay
bd	Bangladesh	il	Israel	qa	Qatar
be	Belgium	in	India	re	Reunion (French)
bf	Burkina Faso	int	International	ro	Romania
bg	Bulgaria	io	British Indian Ocean Territory	ru	Russian Federation
bh	Bahrain	iq	Iraq	rw	Rwanda
bi	Burundi	ir	Iran	sa	Saudi Arabia
bj	Benin	is	Iceland	sb	Solomon Islands
bm	Bermuda	it	Italy	sc	Seychelles
bn	Brunei Darussalam	jm	Jamaica	sd	Sudan
bo	Bolivia	jo	Jordan	se	Sweden
br	Brazil	jp	Japan	sg	Singapore
bs	Bahamas	ke	Kenya	sh	Saint Helena

Domain	Country	Domain	Country	Domain	Country
bt	Bhutan	kg	Kyrgyz Republic (Kyrgyzstan)	si	Slovenia
bv	Bouvet Island	kh	Cambodia, Kingdom of	sj	Svalbard and Jan Mayen Islands
bw	Botswana	ki	Kiribati	sk	Slovak Republic
by	Belarus	km	Comoros	sl	Sierra Leone
bz	Belize	kn	Saint Kitts & Nevis Anguilla	sm	San Marino
ca	Canada	kp	North Korea	sn	Senegal
cc	Cocos (Keeling) Islands	kr	South Korea	so	Somalia
cd	Congo, The Democratic Republic of the	kw	Kuwait	sr	Suriname
cf	Central African Republic	ky	Cayman Islands	st	Saint Tome (Sao Tome) and Principe
cg	Congo	kz	Kazakhstan	su	Former USSR
ch	Switzerland	la	Laos	sv	El Salvador
ci	Ivory Coast (Cote D'Ivoire)	lb	Lebanon	sy	Syria
ck	Cook Islands	lc	Saint Lucia	sz	Swaziland
cl	Chile	li	Liechtenstein	tc	Turks and Caicos Islands
cm	Cameroon	lk	Sri Lanka	td	Chad
cn	China	lr	Liberia	tf	French Southern Territories
co	Colombia	ls	Lesotho	tg	Togo
com	Commercial	lt	Lithuania	th	Thailand
cr	Costa Rica	lu	Luxembourg	tj	Tadjikistan
cs	Former Czechoslovakia	lv	Latvia	tk	Tokelau
cu	Cuba	ly	Libya	tm	Turkmenistan

Continued

Table 9-1 (continued)

Domain	Country	Domain	Country	Domain	Country
cv	Cape Verde	ma	Morocco	tn	Tunisia
cx	Christmas Island	mc	Monaco	to	Tonga
cy	Cyprus	md	Moldavia	tp	East Timor
cz	Czech Republic	mg	Madagascar	tr	Turkey
de	Germany	mh	Marshall Islands	tt	Trinidad and Tobago
dj	Djibouti	mil	USA Military	tv	Tuvalu
dk	Denmark	mk	Macedonia	tw	Taiwan
dm	Dominica	ml	Mali	tz	Tanzania
do	Dominican Republic	mm	Myanmar	ua	Ukraine
dz	Algeria	mn	Mongolia	ug	Uganda
ec	Ecuador	mo	Macau	uk	United Kingdom
edu	Educational	mp	Northern Mariana Islands	um	USA Minor Outlying Islands
ee	Estonia	mq	Martinique (French)	us	United States
eg	Egypt	mr	Mauritania	uy	Uruguay
eh	Western Sahara	ms	Montserrat	uz	Uzbekistan
er	Eritrea	mt	Malta	va	Holy See (Vatican City State)
es	Spain	mu	Mauritius	vc	Saint Vincent & Grenadines
et	Ethiopia	mv	Maldives	ve	Venezuela
fi	Finland	mw	Malawi	vg	Virgin Islands (British)
fj	Fiji	mx	Mexico	vi	Virgin Islands (USA)
fk	Falkland Islands	my	Malaysia	vn	Vietnam
fm	Micronesia	mz	Mozambique	vu	Vanuatu
fo	Faroe Islands	na	Namibia	wf	Wallis and Futuna Islands

<i>Domain</i>	<i>Country</i>	<i>Domain</i>	<i>Country</i>	<i>Domain</i>	<i>Country</i>
fr	France	nato	NATO (this was purged in 1996 – see hq.nato.int)	ws	Samoa
fx	France (European Territory)	nc	New Caledonia (French)	ye	Yemen
ga	Gabon	ne	Niger	yt	Mayotte
gb	Great Britain	net	Network	yu	Yugoslavia
gd	Grenada	nf	Norfolk Island	za	South Africa
ge	Georgia	ng	Nigeria	zm	Zambia
gf	French Guyana	ni	Nicaragua	zr	Zaire
gh	Ghana	nl	Netherlands	zw	Zimbabwe
gi	Gibraltar	no	Norway		
gl	Greenland	np	Nepal		

Forward lookups

Name-to-address resolution is referred to as a *forward DNS lookup*. This is the normal operation of DNS used by most applications. In this case, the user sends a DNS query to resolve the actual IP address that corresponds with a domain name. In addition to providing a convenience to the user, the mechanics of forward lookups enable a domain to implement load balancing (see Figure 9-3).

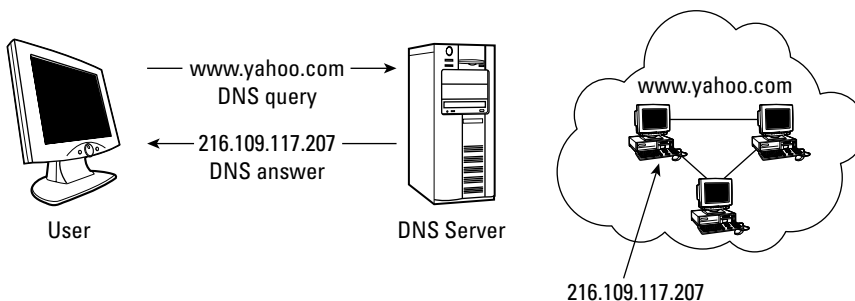

Figure 9-3: Forward lookups translate domain names into IP addresses.

As the preceding figure depicts, the single server name `www.yahoo.com` can actually represent a cluster of hosts. Each of these hosts has a unique IP address.

Depending on current load, DNS may respond with a different IP address to the same user request, as depicted in the following code example:

```
blinky@site$ ping www.yahoo.com
PING www.yahoo.akadns.net (216.109.118.70) 56(84) bytes of
data.
64 bytes from p7.www.dcn.yahoo.com (216.109.118.70): icmp_seq=1
ttl=53 time=11.1 ms

blinky@site$ ping www.yahoo.com
PING www.yahoo.akadns.net (216.109.117.204) 56(84) bytes of
data.
64 bytes from p17.www.dcn.yahoo.com (216.109.117.204):
icmp_seq=1 ttl=52 time=13.7 ms
```

Both of the preceding DNS requests are to the site `www.yahoo.com`, but each responds using different IP addresses.

Address information within name servers is optimized to provide the fastest feedback to a forward query as possible. To do this, it is arranged categorically based on top-level domains, domains, and subdomains. An example of this type of representation is shown in Figure 9-4.

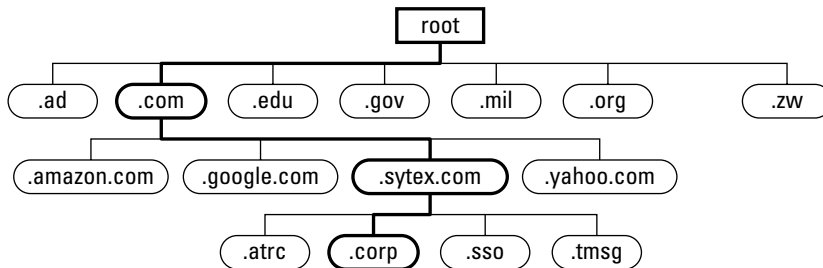

Figure 9-4: Name server data storage for fast forward lookup queries

Reverse lookups

Address-to-name resolutions are called *reverse DNS lookups*. As the name suggests, they are the exact opposite of the forward lookups. In general, these queries are not made manually by users because users tend to remember host and domain names better than IP addresses. Instead, they are used frequently by computers, which prefer numbers.

Reverse lookups are commonly implemented in network-related applications such as server-logging programs and sniffers.

For example, take a look at how two different representations of the same exact line from a tcpdump sniffer log compare:

```

21:00:38.327998          10.1.1.100.50758 >
66.35.250.150.http: S
3708138522:3708138522(0) win
5840 <mss
1460,sackOK,timestamp
22373740 0,nop,wscale 0> (DF)

21:00:38.327998          10.1.1.100.50758 >
Slashdot.org.http: S
3708138522:3708138522 (0) win
5840 <mss
1460,sackOK,timestamp
22373740 0,nop,wscale 0> (DF)

```

The entry on the left does not resolve the IP addresses, whereas the entry on the right does. The application itself processes the packet based on its address, but the address is converted into a human-readable domain name for convenience to the user.

Strangely enough, this means that the representation started as a domain name, was converted to an IP address for the application, and then reconverted into a domain name.

Reverse lookups are also occasionally used to determine the domain of from where a user is originating. This can be used as a method of authorization.

As an example, a user may only want to allow hosts from company.com to access a server. Entering all of the allowed IP addresses into an inclusive filter would be time consuming and require constant maintenance as new hosts are added or removed. Using domain names in the filter means the filter is able to do a reverse lookup to obtain all of the IPs tied to that filter and block anyone coming from a specific domain. This is much easier than trying to list every single IP address.

Conventional storage within a name server is optimized to provide fast results based on forward reverses. Because several ranges of IP addresses can be associated with single domain names, each and every domain must be searched until the requested IP address is located. This is inefficient and impractical.

The alternative is to provide a second organization of information within a name server that is specifically designed to quickly field reverse queries. This is done by storing the data in the reverse order (that is, by IP address instead of domain). Commonly referred to as the in-addr.arpa domain, data is organized hierarchically by IP addresses (see Figure 9-5).

However, because domain names are read from leaf to root, it is actually written as 26.146.145.146.in-addr.arpa, where 26 is the least significant of the address octets.

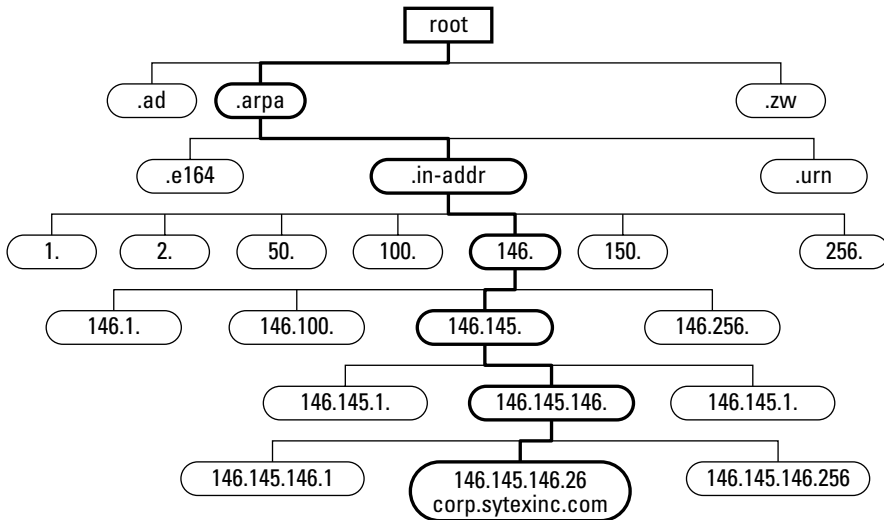

Figure 9-5: Name server data storage for fast reverse lookup queries

Alternative Approaches to Name Resolution

Name resolution can also be implemented using the `/etc/hosts` file on UNIX operating systems. This is similar to the `hosts.txt` file that was used originally before distributed naming was implemented.

Following is an example of an entry that does this:

```
# Do not remove the following line, or various programs
# that require network functionality will fail.
127.0.0.1    localhost.localdomain    localhost
66.97.36.189 www.uberhaxor.com    hxr
```

The second line tells the operating system that requests for the fully qualified domain `www.uberhaxor.com`, or the nickname `hxr`, should be directed to the IP address `66.97.36.189`.

Following is an example of a ping that uses Internet domain name resolution (before the change to the `/etc/hosts` file is made):

```
blinky@site$ ping www.uberhaxor.com
PING www.uberhaxor.com (66.97.36.189) 56(84) bytes of data:
64 bytes from www.uberhaxor.com (66.97.36.189): icmp_seq=1
ttl=49 time=31.7 ms
```

```
64 bytes from www.uberhaxor.com (66.97.36.189): icmp_seq=2
ttl=49 time=23.0 ms

--- www.uberhaxor.com ping statistics ---
2 packets transmitted, 2 received, 0% packet loss, time 1009ms
rtt min/avg/max/mdev = 23.065/27.416/31.767/4.351 ms
```

After the file is saved, the ping functions seamlessly without any intervention from the user using */etc/hosts* for resolution, as demonstrated in the following example:

```
blinky@site$ ping hxr
PING www.uberhaxor.com (66.97.36.189) 56(84) bytes of data.
64 bytes from www.uberhaxor.com (66.97.36.189): icmp_seq=1
ttl=49 time=33.3 ms
64 bytes from www.uberhaxor.com (66.97.36.189): icmp_seq=2
ttl=49 time=33.0 ms

--- www.uberhaxor.com ping statistics ---
2 packets transmitted, 2 received, 0% packet loss, time 1012ms
rtt min/avg/max/mdev = 33.089/33.209/33.329/0.120 ms
```

Security Issues with DNS

Too often, DNS servers are installed on old servers that are not capable of servicing large central processing units (CPUs) and bandwidth-intensive applications. This hand-me-down approach lends itself to accidental utilization of outdated and vulnerable operating system releases.

In addition, DNS servers require little manual maintenance, so they are often neglected when it comes time to log monitoring and patch installation.

In contrast, maintaining authority for domain names and IP addresses is a tremendously important responsibility.

Together these factors mark DNS servers as a high target of interest among attackers. As demonstrated in the following sections, gaining access to a DNS server can provide broader access to clients that rely on and trust it.

Yet passwords and access to accounts capable of updating records with providers are often handled with little security. After administrators move on to other positions, passwords are changed for remote access accounts, but seldom is the account for domain registration changed, or the certificate key changed for DNS servers. Consequences of not doing so could be dire to a company.

AOL DNS Update from a Spoofed E-mail

Early on the morning of October 16, 1998, someone spoofed an e-mail from an AOL official to the InterNIC domain registration service. Because AOL had chosen the default registration and update method, this single e-mail was able to cause all external AOL traffic to be redirected to the Internet service provider autonet.net.

Transmission problems were discovered as early as 5 a.m. that morning, and lasted until the late afternoon. Autonet.net was overwhelmed with thousands of misrouted e-mails. In parallel to repairing the incorrect DNS record, AOL was forced to rent a server for autonet.net to redirect e-mail back to AOL servers. Following is a DNS registration snapshot for the domain that day:

```
blinky@site$ whois aol.com
```

```
[rs.internic.net]
```

```
Registrant:
```

```
America Online (AOL-DOM)  
12100 Sunrise Valley Drive  
Reston, VA 20191  
US
```

```
Domain Name: AOL.COM
```

```
Administrative Contact:
```

```
O'Donnell, David B (DB03) PMDAtropos@AOL.COM  
703/265-5666 (FAX) 703/265-4003
```

```
Technical Contact, Zone Contact:
```

```
America Online (AOL-NOC) trouble@AOL.NET  
703-265-4670
```

```
Billing Contact:
```

```
Barrett, Joe (JB4302) BarrettJG@AOL.COM  
703-453-4160 (FAX) 703-453-4001
```

```
Record last updated on 15-Oct-98.
```

```
Record created on 22-Jun-95.
```

```
Database last updated on 16-Oct-98 04:27:25 EDT.
```

```
Domain servers in listed order:
```

```
DNS1.AUTONET.NET          206.88.0.34  
DNS2.AUTONET.NET          206.88.0.66
```

The InterNIC Registration Services database contains ONLY non-military and non-US Government Domains and contacts.

Other associated whois servers:

American Registry for Internet Numbers	- whois.arin.net
European IP Address Allocations	- whois.ripe.net
Asia Pacific IP Address Allocations	- whois.apnic.net
US Military	- whois.nic.mil
US Government	- whois.nic.gov

Misconfigurations

DNS misconfiguration can lead to the following:

- ♦ **Service redirection**— Site `downloads.com` is a popular location to acquire free and shareware software applications. If DNS requests to this site were instead redirected to the IP address of a malicious attacker's site, a user might download tainted software without realizing it. If the user trusts the site and does not verify the authenticity through cryptographic signature hashes, the consequences could be monumental. Execution of the tainted software could silently install rootkits and other backdoors.

Unscrupulous companies could also use the same approach to redirect traffic from a competitor's Web site to their own.

Similarly, name servers with MX records can be modified to redirect e-mail from one domain to another.

- ♦ **Denial of service**— The same misconfiguration approaches previously listed can instead be used for simply denial of service. Instead of redirecting records elsewhere, they can be redirected to `10.1.1.1` or another address range that does not exist. Changing a record to a nonexistent IP address means every time someone tries to resolve a domain name they are sent to a server that does not exist and, therefore, cannot resolve the name. This results in a denial-of-service attack.
- ♦ **Information leakage for recognizance**— DNS servers maintain significant amounts of information about the architecture of a network. For example, many server naming conventions in companies are descriptive of the services provided by the server. For example, `ns1.company.com` is likely the primary name server while `ns2.company.com` is likely the backup. Similarly, `mail.company.com` is likely the mail server and `www.company.com` is the Web server. Obtaining DNS records can provide an attacker with a complete database of these names along with their associated IP addresses. This database can provide the attacker with recognizance information needed to target specific hosts without actively scanning the network itself.

Zone transfers

For efficiency and accuracy automated methods have been introduced to ensure that information across primary and secondary name servers is kept up-to-date. Domain record exchanges such as this can reconfigure packet routing across a network.

Zone transfers are one method of doing this. Zone transfers operate as a service that periodically creates connections to primary services to update table information.

Historical problems

Past versions of name servers had design and implementation issues associated with this service. Older versions included no security, and virtually anyone with access to programs like `nslookup` and `dig` were capable of issuing them.

Beyond the danger of modifying or exposing sensitive information, these events were also resource intensive. BIND version 4, for example, created a new named process using `fork()` for each zone transfer. In addition, zone transfers could each be up to 64K in size, which when performed on a large scale in a malicious manner, could take up precious bandwidth.

As short as three years ago nearly every server allowed zone transfers to be initiated by any host. Now, nearly all prevent all unauthorized transfers. This hides sensitive server and IP address information from those that do not have a legitimate need to know.

Specifying transfer sites

The UNIX BIND name server uses the field `allow-transfer` in the zone statement for just this purpose:

```
zone "sytexinc.com"    {
    type master;
    file "data.sytexinc.com";
    allow-transfer { slave-1-IP-addr; slave-2-IP-addr; };
}
```

The preceding master statement specifies that it is allowed to transmit zone information to (and only to) the IP addresses of `slave-1` and `slave-2` DNS servers. Alternatively, a slave should not transmit to anyone in most configurations. An example of an appropriate configuration for a slave follows:

```
zone "sytexinc.com"    {
    type slave;
    file "copy.sytexinc.com";
    allow-transfer { none; };
}
```

TSIG for requiring certificates

Transaction Signatures (TSIGs) can provide additional security for conventional zone transfer services. Instead of limiting transfers purely based on IP address, sites can maintain cryptographic signatures that further warranty their authority.

Starting with BIND 8.2, this can be implemented using a shared secret key. This key is stored in a record for each allowed transfer site. Following is an example:

```
key "rndckey" {
    algorithm hmac-md5;
    secret "k6ksRGqf23QfwrPPsdhbn==";
};

zone "sytextinc.com" {
    type master;
    file "data.sytextinc.com";
    allow-transfer { key "rcdnkey"; };
};
```

In this example, only DNS zone transfer requests that have been signed with the shared secret key "k6ksRGqf23QfwrPPsdhbn==" are processed.

The benefit of this approach versus the previous IP address restriction is that it allows for more flexibility. Name servers configured with dynamic addressing schemes (that is, DHCP) will not operate using the previous approach, but as long as they are knowledgeable of the shared key they will operate in this circumstance.

On the slave, the configuration file would include the following:

```
key "rndckey" {
    algorithm hmac-md5;
    secret "k6ksRGqf23QfwrPPsdhbn==";
};

zone "sytextinc.com" {
    type slave;
    file "data.sytextinc.com";
    allow-transfer { none; };
};

server master-IP-addr {
    keys { "rndckey"; };
};
```

This identifies that all requests designed for the IP address of the master name server should be signed with the shared secret key "rndckey".

The weakness of this design is that shared secret keys are used between the two servers, which means that if one server is compromised, the key has been exposed and all are vulnerable.

DNS security extensions

Similar to TSIG, DNS security extensions (DNSSEC) are designed to provide an authorization method for name server queries. However, unlike TSIG, DNSSEC relies on public key cryptography. This model is described in more detail in RFC 2535. However, past experiments have shown that issues exist with this key handling in this design and the Internet Engineering Task Force (IETF) is currently reviewing revision drafts. Although no new RFC has been published yet, it is anticipated that 2535bis will become the standard.

The benefit of using a public key infrastructure is that configurations can be transmitted without fear of compromise, and the exploitation of one server does not automatically expose the keys of all servers.

A key file in this scheme would resemble the following:

```
trusted-keys {
    "." 256 3 1 "AsfFGnuB5FGD87VdjwbyMQxuMs4DSVDSSsdcxr6xR
                ffg67jmRdtisIskoAhw4tingujdyWCCXFFG455sd6
                70K7FS1TARDIjr3hXfTLDS5HnP";
};
```

DNSSEC creates larger DNS messages and larger zones, which, in turn, requires additional bandwidth and processing resources.

Zone transfer alternatives

Several popular alternatives exist to conventional zone transfers. The secure copy program, scp (which is part of the OpenSSH distribution), is one example. By default, this program is manual, but it can be combined with scripts and automated distributed file maintenance methods such as rsync and rdist.

Enumerating Domain Names

With the archives generated on the Internet, searching on www.google.com and other sites (particularly those that cache) is an effective approach to enumerate server and domain names.

For example, suppose you did a search on www.google.com for senate.com servers. Your search would result in the enumeration of hundreds of senate.com servers. Similar searches for non-Web-based servers can be done by searching for specific banners or characteristics, such as "@" to find mail servers.

Predictable query IDs

Busy name servers have the potential of servicing many requests at the same time. Because all communication occurs across the same port, a query ID is included within a packet to uniquely identify sessions. These numbers start at a set number generated by the server and increment with each request. A predictable query ID within a request is a security issue that allows an attacker to poison domain name server caches with forged address resolution information.

For example, an attacker can send a forward lookup query to a high-level DNS server requesting an IP address. In response, the DNS server sends a query on behalf of the client down to a lower-level server.

Simultaneously, the attacker floods the high-level DNS server with malicious responses to mimic what was expected from the legitimate low-level server. If the high-level server has implemented predictable sequences of query IDs, the server trusts this illicit response and places it in its cache for future reference.

When a DNS issues many queries at once, this attack could be used to poison large spans of domain names and redirect innocent users to incorrect sites.

As a result, newer DNS servers have been modified to use random query IDs to reduce the breadth of this attack.

Recursion and iterative queries

DNS servers are designed to respond to two different types of queries: recursive and iterative. Recursive queries are from local *users* and iterative queries are from remote name *servers*.

Recursive queries are the most difficult for a name server to handle because the server is ultimately responsible for providing a final answer to the question. Recursive queries respond with either the requested address or an error.

Iterative queries, on the other hand, respond with a refer-to answer if the address is not currently known. The difference between the two becomes important later with security issues related to query types.

The process of a DNS request on the Internet begins with a recursive query arriving at a local name server. This server must either respond with the answer or respond with an error that an answer does not exist.

If the query name is not in the name server's cache, the current name server in turn asks the same question to a name server it knows of that most closely fits the requested domain. This query generated on the local name server could potentially be recursive, but that is considered to be in bad taste because it causes undue work on other servers that are not owned by the provider.

As is the nature of iterative queries, this name server will either respond with an answer, or refer the original server to a closer match. The process repeats until the original server receives an answer to the original query. Figure 9-6 depicts this event.

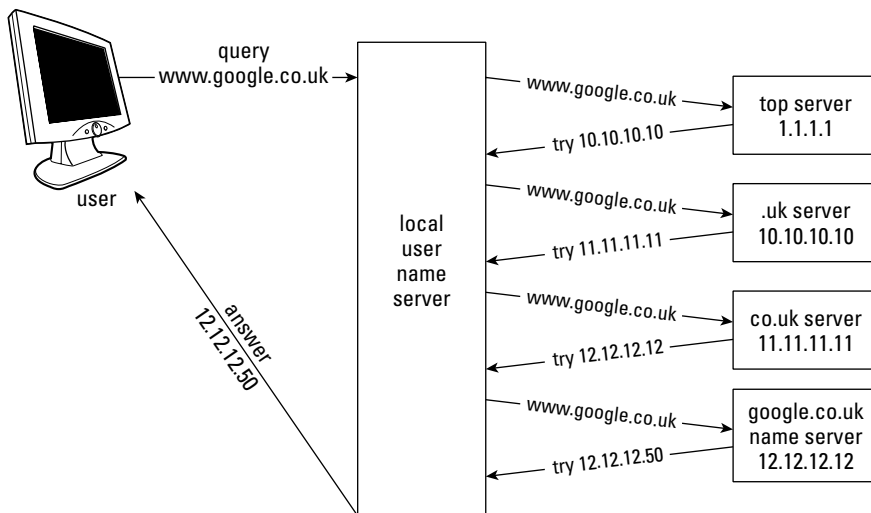

Figure 9-6: DNS servers processing a recursive query systematically ask servers that appear to be the most likely to be knowledgeable about the requested address.

Although it is possible for the local server to send recursive queries to the external servers, in practice it is seldom done. Most queries that originate from a recursive query at a local name server are instead iterative, as depicted in Figure 9-6.

DNS Attacks

Because DNS is responsible for translating a domain name (which users prefer) to an IP address (which computers like), it is often a target of attack. If an attacker can get in and modify a DNS record so that it resolves to an incorrect IP address, they can cause all traffic for that site to go to the wrong computer. This section looks at some of the common attacks on DNS.

DNS Vulnerability Statistics

A Domain Health Survey for .com sites by www.menandmice.com in 2003 illustrates the high likelihood of attack success on DNS servers.

- ◆ 68.4 percent were misconfigured.
- ◆ 27.4 percent have all name servers on the same subnet.
- ◆ 18.4 percent maintain records that point to an incorrect host.
- ◆ 16.1 percent lack the correct match of delegation data and zone data.
- ◆ 16.4 percent have nonresponding authoritative name servers.
- ◆ 43.3 percent block zone transfer from all name servers.

Simple DNS attack

DNS spoofing on a local network is the most simple and easy-to-implement name service attack. As illustrated in Figure 9-7, the victim attempts to view the Web site www.download.com. Because the victim has not been to the Web site recently, a cached entry of the IP address does not exist in the client's Address Resolution Protocol (ARP) table. Therefore, the victim's computer issues a query for www.download.com to its local DNS server.

The malicious attacker observes this DNS query and instantaneously a spoofed response is returned to the victim. On local networks it is trivial to identify this traffic because name servers are widely advertised. In addition, all traffic related to the request travels on UDP port 53. As a result, the victim receives the response from the malicious attacker before the DNS server is able to issue and receive responses from a recursive query to the true authority for www.download.com.

The first response received by the requesting victim “wins” and the secondary response is simply discarded.

Cache poisoning

Attackers that reside on the same local network as the victim are able to execute simple “race” condition response spoofs to redirect traffic. When attackers are not able to reach local servers directly the exploitation method becomes slightly more complex. The most common technique to attack victims in this case is to poison the cache of their DNS server.

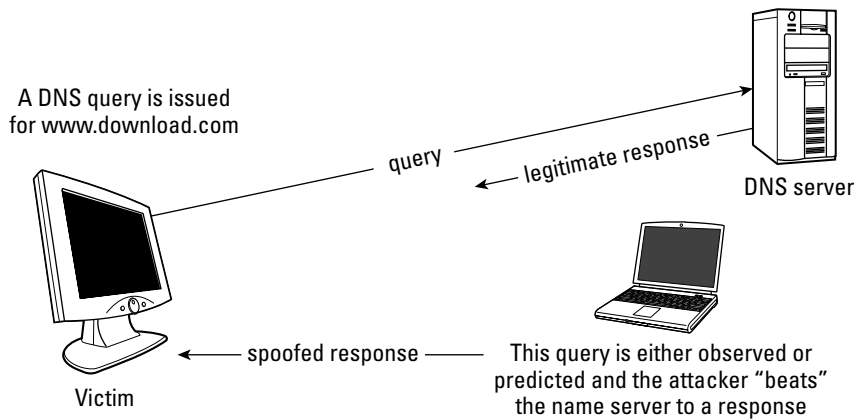

Figure 9-7: Illustration of a simple DNS attack that redirects traffic destined to `www.download.com` to a malicious site because the DNS query response from the attacker is received before the legitimate response arrives

Cache poisoning means that entries in the server have been maliciously modified although the victim continues to trust the responses supplied by the server. There are several methods of doing this, the first of which became publicly available in 1993 (see "Implementation Flaws that allow cache poisoning" for more details).

One of the more difficult attacks to prevent against is the birthday attack, illustrated in Figure 9-8. The birthday attack method of DNS cache poisoning launches spoofed DNS queries and requests instantaneously with a valid user request. Mathematically, as the number of queries reaches 700, the possibility of a collision reaches nearly 100 percent. A *collision* occurs when the real number that was generated by the server and the guess are the same, which means the attacker successfully guessed the query and can spoof the response.

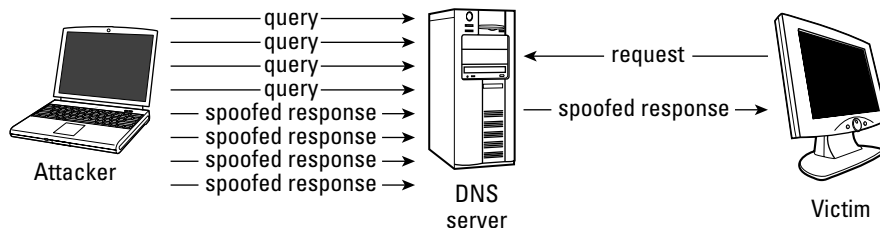

Figure 9-8: The birthday attack method of DNS cache poisoning

Designing DNS

Unfortunately, when most companies set up an infrastructure, functionality is all that matters, not security. If you successfully set up a system and everything is working, you assume you are done. However, just because it is working does not mean that it is secure. Securing DNS requires that the system be properly configured and properly designed.

Split DNS

Simply put, a split DNS design splits the address range of your network into internally and externally reachable zones. An internal server receives query requests from users and forwards them to an outside server that makes recursive queries on its behalf. Although this design protects against most exploitation related to application vulnerabilities such as buffer overflows, it does not protect against cache poisoning. While better than a single external DNS server, this design is not the most optimal approach and should be replaced with a split-split design, if possible.

**Note**

A bastion host is a dual-homed server that has routable interfaces in both sides of a split namespace. This host operates as a gateway between the two, and is designed to protect against attacks against internal resources.

Split-split DNS

Split-split DNS is the most recommended DNS system design. Using physical separation, it is capable of disabling recursive queries from the Internet on name servers that service your users. This design prevents external attackers from poisoning the DNS cache seen by internal resources.

Designing a split-split architecture means that you have two name servers. As Figure 9-9 illustrates, the name server on the left resides on your internal IP address subnet and does nothing but issue recursive queries for your users. The name server on the right serves public domain information for external parties and does not issue recursive queries.

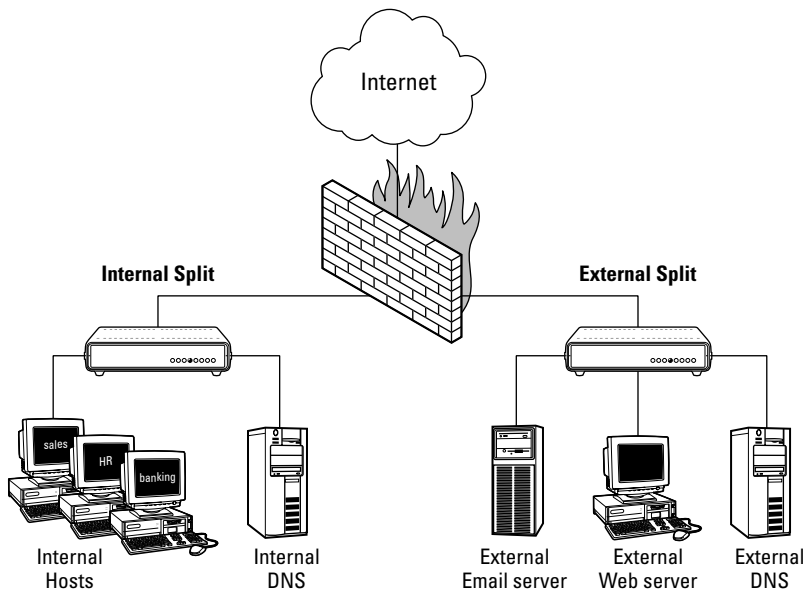

Figure 9-9: A split-split DNS architecture uses complete physical separation of internal recursive queries and external public name service to prevent DNS cache poisoning.

Implementation Flaws that Allow Cache Poisoning

Following is a list of implementation flaws that can contribute to cache poisoning:

- ♦ 2004 – Secunia released an advisory (SA11888) that applied to Symantec Firewall products. The DNS caching engine trusted any answer received from a DNS server.
- ♦ 2002 – The Brazilian Research Network CSIRT and Vagner Sacramento released an advisory (VU#457875) that applied a birthday attack to Berkeley Internet Name Domain (BIND). They demonstrated that it was mathematically possible for BIND to send multiple simultaneous recursive queries for the same IP address.
- ♦ 2001 – CERT released an advisory (CA-2001-09) based on the paper that Michael Zalewski wrote entitled “Strange Attractors and TCP/IP Sequence Number Analysis.” This was based on the ability to predict transaction ID/UDP port pairs.
- ♦ 1997 – CERT released an advisory (CA-1997-22), which described a vulnerability in the BIND software that was released. This vulnerability had to do with the query IDs being sequential, which led to predictability and mass poisoning.
- ♦ 1993 – Christoph Schuba authored “Addressing Weaknesses in the Domain Name System Protocol.” This paper introduced the concept of cache poisoning, with the most notable vulnerability being the inclusion of additional information in a DNS reply packet.

Master Slave DNS

Redundancy and load balancing requires that networks house more than one DNS server. However, as the number of servers increases, so does the amount of time required to administer them.

One method to reduce administration responsibilities is to implement *master* and *slave* relationships among them. With this plan, only one server (the master) must be manually configured with changes to addresses and domain names. All remaining servers (the slaves) receive their information in an automated fashion from other servers. This transmission of information is commonly referred to as a *zone transfer*, and was discussed previously in this chapter.

When configured, changes to zone files cause the maintainer of the change (generally the master) to send a NOTIFY announcement to its slaves. To identify if a slave server should be updated with new information, zone files contain an incrementing serial number. Each change of the file raises this number, which indicates a more recent copy. Slave servers that determine that their serial number is lower will request an update.

In general, updates to slave servers are only acquired from the master server. However, it is possible for them to acquire the information from each other. Precautions in terms of carefully changing DNS must be taken to insure that transfer loops are not created by this configuration. For example, if a change is made to slave-server-1, and slave-server-2 acquires it but is told to send changes to slave-server-1, this process could loop infinitely.

Detailed DNS Architecture

When selecting the proper DNS architecture for your organization, it is important to keep in mind the critical role that name translation plays. Without it, although firewalls and routers are functioning properly, your users' Internet service will become virtually useless. Redundancy is critical.

The most secure of all designs is to implement a split-split architecture. This design should incorporate no less than two internal DNS servers for every 500 users. Organizations that require multiple servers due to network size should space them out in a load-balancing manner to produce the most efficient architecture.

For users that operate over WAN or other long-distance connections, it is most efficient to locate servers within close proximity so that each query does not have to traverse across the distance of the WAN.

Policy must be set in place and followed to ensure that the DNS server software and its underlying operating system is maintained and kept up-to-date with patches and new software releases. A host-based intrusion detection system (HIDS) should be installed on the server and frequently monitored. Undetected compromise of this machine could lead to a malicious user preventing access as a denial-of-service attack, or worse, redirecting traffic to sites containing misinformation and trojaned software.

Summary

DNS plays a critical role in an organization's security posture. Of all servers, DNS is the one that every organization must have if it want to allow people to use domain names to access their company's resources. This chapter laid out the fundamentals of DNS and what needs to be done to secure it.



Server Security

In a simplistic view, network security can be grouped into three categories: the user workstation, the network devices, and the servers. The user workstation is important to secure because it potentially holds all the information to which a particular user may have access. Additionally, if the workstation is compromised, its attacker can (usually) do everything that a user would be authorized to do. Network devices allow users to interact with other users and servers. Network devices are often targeted because they are usually configured more for performance than security. The third category, servers, has its own reasons for being a security target, which are explored in this chapter.

General Server Risks

In the past, most of the attacks on networks have been focused on servers. Network servers are prime targets for the following reasons:

- ◆ **They hold large volumes of critical data.** In the same way that banks are robbed because “that is where the money is,” hackers are very interested in servers and the data that they hold.
- ◆ **If compromised, a server may provide the attacker access to many workstations.** Most setups are such that the server is trusted and the workstation must authenticate to the server. This may leave the workstation vulnerable to attack if the server has been compromised.
- ◆ **Servers often are easy to find.** Most setups are such that the workstation easily finds the server and uses authentication to restrict access. An attacker is likely to attack a server they can reach, as opposed to a workstation that they cannot.

10

C H A P T E R



In This Chapter

Introducing general server risks

Designing for security

Operating servers safely

Exploring server applications



- ♦ **Server applications, on average, are more costly and difficult to develop.** In many cases, developers will reduce the cost and risk of this development by using common software packages such as Microsoft IIS Webserver. When common software is used, attackers are able to focus their efforts on a piece of software that they know very well.

Security by Design

In the past, security for server applications has been an afterthought, only to be considered after threats and vulnerabilities have arisen. This led to many instances of security being retrofitted into an operating system or application. One of the lessons learned from retrofitting is that it is very costly and time consuming to try to put in security after an application and system have been developed and deployed. In most cases, the system cannot be made completely secure.

A conservative estimate is that it is 10 times cheaper to build security into a product than to attempt to retrofit it after deployment. If the cost benefit is so great, why then does security still have a difficult time being part of the requirements in most software development efforts? Some of the factors affecting security in the design phase of a development effort are as follows:

- ♦ The software developers and security professionals (network engineers) historically came from different communities. This is still an issue today, although more software developers are attending security training and security conferences.
- ♦ The security threat was not well publicized. Security has made the front page more often in recent years.
- ♦ In many cases, the software developer is working on a topic that they have never coded before. However, a network engineer who designs a network has probably designed dozens of networks in the past.
- ♦ Until recently, software developers could not justify time spent on security features, because they did not seem to affect the bottom line from management's perspective.
- ♦ In the highly competitive marketplace for software, there has been a natural rush-to-market approach to beat the competition.

Even with the heightened attention to security in today's world, it is still an uphill battle to get security rooted into the initial requirements and design of a development effort. Several steps can be taken to improve the security in server applications under development, including the following.

- ♦ Maintain a security mindset in the organization and in the development group.
- ♦ Establish a secure development environment.
- ♦ Use secure development practices.
- ♦ Test frequently and at all levels.

Maintain a security mindset

Having a security mindset is the first step in developing a secure product or having a secure environment. Security improvements will come at a cost of time, money, and convenience. If an organization does not have a mindset that values security, it will be difficult to implement the needed controls. Following are some approaches to improving the security during the software design and development process:

- ♦ **Base security decisions on the risk.** Security can be like insurance; the risk must be known to determine the coverage needed.
- ♦ **Use defense-in-depth.** Many security controls are preferable to a single point of protection.
- ♦ **Keep things simple.** Simplicity and clarity will support a more secure product.
- ♦ **Respect the adversary.** Do not underestimate the interest and determination of the threat.
- ♦ **Work on security awareness.** Security training is needed at all levels of an organization.
- ♦ **Use encryption.** Be paranoid and expect the worst.

Risk-based security controls

Management is often confronted with issues such as “What actions should I take to improve security? How much should we spend on securing this product?” These are common questions every project manager asks when considering security. How to address security is confounded by a number of confusing and ironic aspects of the problem, including the following:

- ♦ The technologies involved are very high-tech and not fully understood by most in management.
- ♦ The threat is usually discussed in terms that don’t readily translate to dollars.
- ♦ The greatest threat is from the inside; but the corporate culture has learned to trust and rely on only those within the organization.
- ♦ The items at risk are not physical and perhaps less tangible — information, reputation, and uptime.

- ◆ People have been shouting “the sky is falling” for a while and nothing serious has happened, yet.
- ◆ There are many solution providers offering security products and services. For the most part, they only provide a partial solution.
- ◆ Spending is not predictive of the security received. A \$30 modem can bypass the security of a \$200,000 firewall installation.

From senior management’s perspective, information security should be viewed as insurance. No corporation would consider operating without fire insurance. Management understands that fires happen. The likelihood of a fire can be reduced but there is always a significant chance that all precautions will break down and a fire will occur. Therefore, insurance is required. Senior management views the acquisition of fire insurance as part of their fiduciary responsibilities. Why should network and software security be any different?

The risk to a server application should be based on the likelihood of an attack to occur and business impact if it does occur. The business impact is best determined by informed stakeholders. Some examples of the stakeholders may be the organization that developed the server application, the organization hosting the service, and the users of the service.

Defense-in-depth

The defense-in-depth principle is best thought of as a series of protective measures that, taken as a whole, will secure the product. The most memorable example is the medieval castle. The king protected his crown jewels (literally) with a series of progressive defenses, including the following:

- ◆ The chosen site for the castle was on a hilltop. It was and always will be easier to defend the top of a hill.
- ◆ Stone walls and terraces were placed around the approaches to the top of the hill.
- ◆ Sharp sticks pointing toward an approaching attacker were placed on the hillside. In today’s world, these would be mine fields.
- ◆ A moat was dug around the hilltop.
- ◆ Vile waste was placed in the moat, sure to discourage the fainthearted from crossing.
- ◆ The outer castle walls were tall and thick.
- ◆ Rocks and hot oil could be dropped from the outer walls, slowing down the attack.
- ◆ There was an inner, smaller fortress to which the population could retreat in the event the outer walls were breached.

No one defense of a castle was relied upon for the ultimate protection. The defenses as a whole were designed to weaken and discourage the attackers. Some defenses were easy and cheap to implement (sharp sticks). Others required significant resources (the outer walls). But taken as a whole, the defense was much stronger than the simple sum of each protective feature.

The defense-in-depth principle applies to software development and server applications as well. Two important features to note are as follows:

- ♦ All the security resources should not be concentrated on a single protection. The classic case of this is when a company spends its entire security budget on a \$200,000 firewall to protect it from the Internet. All of this investment can then be circumvented by a \$30 modem because there was no security awareness program to train users as to the risk of connecting to ISPs directly from their workstations.
- ♦ A protective measure (a security control) is worth implementing even if it seems to be a redundant protection. For example, the use of strong passwords is advised even on internal networks in which all users are trusted.

Keep it simple (and secure)

Complexity, confusion, and uncertainty aid the attacker in exploiting a system or an application. If an application is clear and transparent in its operation, it is more easily secured. The more open the application is to its operations, the more readily security flaws will be seen and corrected. While a transparent development process does not guarantee a good design, a closed process can hide a bad design. It is through bad designs that the most costly security issues arise. If a bad design is not caught early, it may not be correctable from a security perspective.

The designers of a server application are not necessarily the developers and are usually not the operators and maintainers of the service. Clear and concise documentation with respect to security requirements and assumptions are important for when an application is handed from one group to another. If the design's security is predicated on a certain feature (such as 128-bit encryption), this information must be passed along for the life of the server application.

In a very complex server application, different components will have different responsibilities with respect to the security of the system. For example, one component may authenticate users, while another determines what access a user can have to the database data. The logical interfaces between these components are sometimes referred to as *trust boundaries*. Software designers should easily be able to draw out the trust boundaries between all the components of the application or system. If this is a difficult task, perhaps the design is not as simple and, therefore, not as secure as it might be.

Respect the adversary

Software developers are experts at making an application perform as it was designed to perform. Hackers are experts at making server applications do things it was never designed to do.

Designers should plan for the unexpected. Attackers will throw everything they can imagine at the server application trying to invoke an unintended response. Attackers do not play by the rules, and developers should not expect that they would.

Designers should clearly state what the expected normal user interaction should be. These interactions should then be screened for abnormal use of the application. In this way, tests and reviews can consider what bizarre treatment the application might receive at the hands of an attacker.

All applications and hardware fail eventually. When they do, they should fail in as safe a manner as can be predicted. Attackers will seek to crash systems to circumvent security controls. Many serious exploits begin with a service being overloaded and crashing. The attacker then moves on to compromise the system. If fail-safe requirements are stated early in the design process, there is a better chance of the design withstanding these attacks.

Security awareness

A key ingredient to maintaining a secure mindset is a strong security awareness program. Security awareness involves educating developers and network engineers about the security risks involved in a development effort. Following are some key lessons to be covered in an awareness program:

- ♦ **Security policies and the roles and responsibilities when developing applications**—Management should ensure that there are formal roles and responsibilities for developers regarding security-related items. The policy itself offers limited protection. If developed in an open and collaborative process, the big benefit is the security awareness gained.
- ♦ **Product-specific requirements**—A number of domains have external requirements that must be met by a product operating in that domain. For example, financial institutions are responsible for the Gramm-Leach-Bliley Act (GLBA) requirements, and certain credit card companies may impose requirements, such as the Visa Cardholder Information Security Program (CISP) 12-point program. The GLBA, which is also known as the Financial Services Modernization Act of 1999, provides limited privacy protections against the sale of your private financial information. Additionally, the GLBA codifies protections against *pretexting*, the practice of obtaining personal information through false pretenses. The Visa CISP is a 12-point program designed to assist anyone who processes credit cards, where the customer is not present, to secure the credit card information. These top-level principles apply to all entities participating in the Visa payment system that process or store cardholder information and

have access to it through the Internet or mail-order or telephone-order. The following requirements are provided by Visa:

- Install and maintain a working network firewall to protect data accessible via the Internet.
 - Keep security patches up-to-date.
 - Encrypt stored data.
 - Encrypt data sent across networks.
 - Use and regularly update antivirus software.
 - Restrict access to data by business on a need-to-know basis.
 - Assign a unique ID to each person with computer access to data.
 - Don't use vendor-supplied defaults for system passwords and other security parameters.
 - Track access to data by unique ID.
 - Regularly test security systems and processes.
 - Maintain a policy that addresses information security for employees and contractors.
 - Restrict physical access to cardholder information.
- ♦ **Security basics**—This includes passwords, physical security, security policies, roles, and responsibilities.
- ♦ **Security awareness testing**—It is very important to test the basic training. Testing provides insight into risk areas and the need for future training.

Business impact

The impetus and justification for setting up the environment should be to minimize the security risk and reduce the business impact of any attacks. Risk and business impact are covered in detail in Chapters 1, 2, 17, and 18. Business impact in this case is considered to be “the loss avoided, due to the investment.” This is the business impact of the risk that is mitigated by the security controls or measures taken to improve security. Some typical business impacts to be considered are as follows:

- ♦ If significant credit card information is lost, the business impact will be hundreds of man-hours.
- ♦ If a security incident leads to an extensive internal investigation, the business impact will be dozens of man-hours.
- ♦ Damage to customer relations can result in a loss of future business.
- ♦ Damage to an organization's public image.
- ♦ Legal costs to investigate and defend a loss.

Because an organization should base its environment on its own specific risks and needs, the recommendations put forth here should be considered a starting point or general practices.

When considering the threat, developers should keep in mind that the internal LANs and WANs can reach the far corners of an organization. The project manager has a certain amount of insight into the means, access, and motives of his developers, and he may also be informed about other personnel in his location. However, when it comes to employees on the WAN, he has to blindly trust that they will not attack his servers.

The business impact if an attack is successful is a judgment call that only each organization is qualified to make. By way of example, consider the following thought process for the fictitious Acme Publishing company. A vulnerability to mail viruses exists. The threat of a virus hitting Acme's mail servers is high in the next year. The vulnerability and threat combine to give a 5 percent likelihood of getting hit with a virus and losing a day's e-mail. The business impact on Acme from losing e-mail is \$50,000 per day. Only Acme can determine that this is the cost or impact. Therefore, it is worth $(0.05 \times 50,000 = 2,500)$ \$2,500 to install a virus protection defense. In this example, the security risk for this vulnerability/threat/impact combination is \$2,500 annually.

Note that the business impact must include the cost of embarrassment and the loss of good will. Some vulnerabilities have a business impact that is just too high to accept at any threat level. Such a vulnerability, for example, is the miss-handling of credit card numbers. An attack resulting in a loss of credit card numbers would have a crippling impact on business. Consider the impact of the loss of credit card information in California, alone, which is leading the nation in new, tougher privacy laws concerning the disclosure of sensitive data such as credit cards.

Establishing a secure development environment

Having a security-oriented mindset is not sufficient to developing secure server applications. An organization must also establish and maintain a development environment that promotes security. The development environment should address the risk and business impact and cover the following areas:

- ♦ Management
- ♦ Security awareness
- ♦ Software development
- ♦ Configuration control
- ♦ Network security

Management

Secure software cannot be developed without significant management support. Management must value the time and effort put into making a product secure. This value should be based on the reduction of the business impact that can result from a poorly developed product. Management should provide the time and resources to support a secure product development. Additionally, management should establish a security officer and a configuration control process.

Developing a secure product is more costly in the short run. Security requires more design and expertise at the beginning of the software development effort. It takes a strong and insightful management to see this need and to provide the resources and guidance to incorporate security early on in the development process. As discussed earlier, the total cost of developing a secure product is reduced when security is designed into the effort from the beginning. Also, a case can be made that the total cost of a secure product is less than a nonsecure product when the business impact (translated into dollars) is taken into account.

A security officer is key to having a central point of contact for security across all projects and development efforts. A security officer can provide checks and balances for the development leadership, which is often more concerned about performance and keeping to budgets and schedules. The security officer can be the go-to guy when a developer or operator has a security concern or if a security incident arises. The security officer would then be able to escalate the issue to the proper level for its business impact analysis. The security officer should not have authority over the development process but rather act a sounding board and conscience.

Configuration Control Board

Management should establish a configuration control process that supports the developers in design and development of complex applications. Generally, this process is centered on a Configuration Control Board (CCB). The CCB can be responsible for the following:

- ♦ **Establishment of formal change management in development**—Random or uncontrolled changes should be viewed as openings for security vulnerabilities. It is rare that an unforeseen configuration change will make an application more secure. All the effort put into making a secure design can be undercut by not controlling the changes that are inevitable during a development process. The annals of security blunders are full of examples of how previously patched vulnerabilities are reintroduced into a product with a subsequent patch or upgrade.
- ♦ **Establishment of formal requirements and testing program**—Over time or during development, an application may be diverted from the original security requirements set down for the application. It is not uncommon for the design document to have requirements that are not fulfilled because they were not goals of acceptance testing and regression testing.

- ♦ **Coordination of developers, deployment, and networking responsibilities**— The CCB monitors the progress of development and deployment, with an eye to security needs. The board coordinates the actions required in response to high-level changes in the product, platform, or network. The members of the CCB use the information provided by other members of the board to plan their own security activities. The CCB should be chaired by the security officer. The membership includes representatives from the developers, the project delivery groups, and the network administrators. Figure 10-1 illustrates the coordination that the CCB provides.

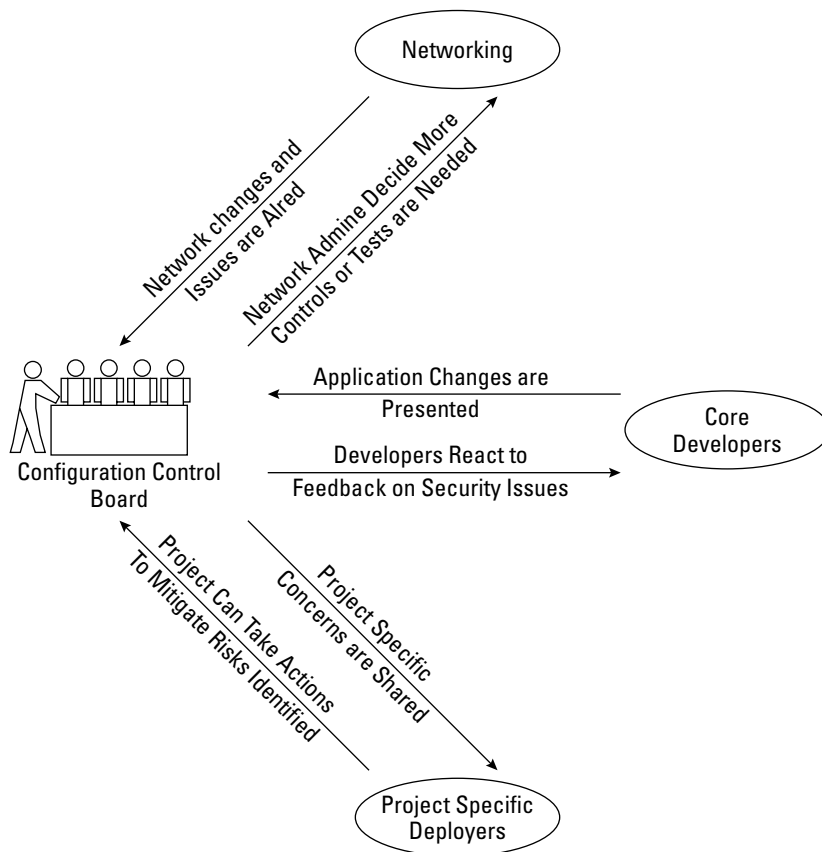

Figure 10-1: The CCB coordinates and informs on security issues.

Network support for development

Generally speaking, software developers and network engineers have different backgrounds and career paths. As a result, neither camp fully appreciates or understands what the other does. In many organizations, this leads to a throw-it-over-the-wall attitude in which software is designed, developed, and tested in a development environment and then given to network engineers and deployment personnel to be placed in an operation setting. This can result in a misunderstanding as to what the security requirements are for a given server application.

Following are some ways in which the network engineers and developers can work more closely together to maximize the products security:

- ♦ **Establishment of a test environment**—Most testing is currently done on either development systems or archived copies of deployed systems. Network administrators and developers need more flexibility to make configurations and changes.
- ♦ **Establishment of formal change management for the development and operational networks**—If the networks associated with the server application are not securely maintained, there is a risk that a logic bomb or malicious code (virus, and so on) could be inserted into the application. Software developers generally are not network engineers and may not be able to recognize whether a supporting network is secure or not. Network engineers may not appreciate the risk to the software under development when configuring the network. A body overseeing both the network and the development effort, such as the CCB, can be effective in securing the network environment, as needed.
- ♦ **Establishment of a program for continuous network assessment**—Critical software development networks should require a high level of network security. Often, a development network is well inside an organization and away from the Internet. In many organizations, this would lead to an increased trust of users on the network and less monitoring for suspicious activity. A configuration control program or CCB should require that network engineers apply a high level of scrutiny on the development networks and aggressively pursue any discrepancies. In most cases, this involves continuous monitoring with intrusion detection systems (IDS) and periodic security scans.
- ♦ **Use of a firewall or establishment of a VLAN for developers**—Developers should be exposed to a firewall, or functionally grouped in a virtual local area network (VLAN) to prevent nondevelopment personnel without a need to know from getting access to development workstations and servers. (If not already implemented, this should be done for other sensitive groups, such as Human Resources and Finance, as well).

Secure development practices

There are many methods for developing code. Any of them can be used to develop a secure application. Every development model must have both requirements and testing. In some models the requirements may emerge over time. It is very important that security requirements are laid down early in the development process.

Security in an application tends to be subtle and invisible. Security is prominent on only two times in the development life cycle: requirements definition and testing. At other times, deadlines, capabilities, performance, the look and feel, and dozens of other issues tend to push security to the back. This is why it is important to be sure that security requirements are prominent at that beginning of the development life cycle.

In many respects, the tools and techniques used to design and develop clean, efficient applications will support the development of secure code, as well. Some special interest, however, should be taken in the following areas:

- ♦ **Handling of data**—Some data is more sensitive and requires special handling.
- ♦ **Keeping the code clean**—Care must be taken not to expose too much information to a would-be attacker.
- ♦ **Choosing a coding language**—Consider the strengths and weakness of the language used.
- ♦ **Avoiding content injection**—Data (content) entered by a user should never be able to be put directly into a command or query.

Handling data

As the Internet continues to be a driving force in most of our everyday lives, more and more personal and sensitive information will be put on servers. Requirements for handling this private information did not exist five years ago, while other data, such as passwords, has always required special handling. Following are some special cases for the handling of sensitive or critical data:

- ♦ Passwords should never be transmitted in the clear. They should always be encrypted.
- ♦ Passwords should never be viewable on the user's screen as they are entered into the computer. Even though asterisks (*) are being displayed, care must be taken to make sure that it is not just because the font is all asterisks. If that is the case, someone could steal the password by copying and pasting the password from the screen.
- ♦ If possible, passwords should always be encrypted with one-way hashes. This will ensure that no one (not even a system administrator) can extract the password from the server. The only way to break the password would be through brute force cracking. With one-way hashing, the actual passwords are not

compared to authenticate the user; rather the hashed value is stored on the server and is compared with the hashed value sent by the user. If the passwords cannot be decrypted, the user cannot be provided their passwords when they forget them. In such cases, the system administrator must enter a new password for the user, which the user can change upon re-entering the application.

- ♦ Credit card and other financial information should never be sent in the clear.
- ♦ Servers should minimize the transmissions and printing of credit card information. This includes all reports that may be used for internal use, such as troubleshooting, status, and progress reports.
- ♦ Sensitive data should not be passed to the server as part of the query string, such as in the following. The query string may be recorded in logs and accessed by persons not authorized to see the credit card information. For example:

```
http://www.server-site.com/process_card.asp?cardnumber=
1234567890123456
```

Keep code clean

When it comes to information put into server code, a good motto might be, “Be paranoid. Don’t disclose anymore than necessary.” Attackers will spend countless hours gathering information looking for the nugget that will make their task easier. Much of that time will be spent examining HTML and scripts for information that can be used to make their attack easier.

Comments should be stripped from operational code. Names and other personal information, in particular, should be avoided. HTML comment fields should not reveal exploitable information about the developers or the organization. Comments are not bad per se, but those embedded in the HTML or client script and which may contain private information can be very dangerous in the hands of an attacker.

Many times third-party software packages, such as Web servers and FTP servers, will provide banners that indicate the version of the software that is running. Attacker can use this information to narrow their search of exploits to apply to these targets. In most cases, these banners can be suppressed or altered.

Choosing the language

One of the most frequently discovered vulnerabilities in server applications is a direct result of the use of C and C++. The C language is unable to detect and prevent improper memory allocation, which can result in a buffer overflow.

Because the C language cannot prevent buffer overflows, it is left to the programmer to implement safe programming techniques. Good coding practices will check for boundary limits and make sure that the function was properly called. This requires a great deal of discipline from the programmer and, in practice, even the most experienced developers can overlook these checks occasionally.

One of the reasons Java is so popular is because of its intrinsic security mechanisms. Malicious language constructs should not be possible in Java. The Java Virtual Machine (JVM) is responsible for stopping buffer overflows, the use of un-initialized variables, and the use of invalid opcodes.

Input validation and content injection

All input from the user that cannot be trusted must be verified and validated. If the system is to process data that has been provided by an untrusted entity, the data must be validated first. In most client-server interactions, it is difficult for the server to validate the client, so the client should be considered untrusted.

Content injection occurs when the server takes input from the user (client) and applies the content of that input into commands or SQL statements. Essentially, the user's input gets injected into the command that is executed by the server. Content injection can occur when the server does not have a clear distinction and separation between the data input and the commands executed.

There is a fundamental paradigm difference between the developer and the attacker that must be considered when designing Web-based applications. The developer assumes that the user's goals and that of the application are the same. This tends to lull the developer into expecting the user to provide the correct input for the task at hand. The developer may expect errors in the input, but generally he or she expects the user might make honest mistakes. The attacker, on the other hand, looks to use input as a key method of disrupting and disturbing the application. The attacker knows that little is to be gained by proceeding through the application as the developers expect.

As a result, it is essential that developers test all inputs carefully. The checks should assume nothing at the offset. Inputs should be checked for proper characters and proper length. If special characters are allowed in the input, extra care should be taken. Special characters can often have uses in a shell context that are unknown to developers. For example, in a UNIX shell, a dot (.) is the equivalent to "execute the following in this shell." And back ticks (`) around a statement equivalent to "execute this statement in a new (sub) shell."

Cross-site scripting

All the dynamic Web applications on the Internet depend on being able to differentiate between two users hitting the same Web site. Maintaining state like this is normally done using some kind of cookie. Cookies are small pieces of data stored on the client machine and returned with each request to a particular Web site. Cookies can be used to remember a user between visits or to prevent a user from having to log in repeatedly to the same Web application.

One of the security considerations of cookies is that they are supposed to be returned only to the site that issued them. This is important so that a banking cookie isn't sent when visiting a news site and vice versa. But there is a vulnerability that allows rogue scripts to trick a client browser into submitting cookies to a third party. One of the exploits using this vulnerability is cross-site scripting.

Cross-site scripting gets its name from the capability of a script to call up a completely different Web site and, in the process, capture the cookies and information exchanged between the user and that site.



Chapter 7 covers the detailed use of cookies.

The cross-site scripts are typically imbedded in Web pages or sent via e-mail. Users may not even have to click on anything if they access a Web page with compromised code on it. Server applications should not interpret (open links and load Web pages) unless the source of the HTML can be assured to be safe.

SQL injection

SQL injection is the practice of manipulating a database to perform actions that it was not intended to by adding SQL commands to the Web application and having them execute against the database. This is not only a problem for user name and password screens, but anywhere the user has interaction with the database. Consider the following script from a server application:

```
sql = "select username from users
      where userid = ' " & request("userid") & " '
      and password = ' " & request("password") & " ' "
```

This code produces an SQL select command to query the database to check a user name and password. The code gets a user name and password from the user. The request functions provide the user's input. The SQL command is built by putting double quotes (") and single quotes (') around the user's input. If the SQL command is successful, the user name/password combination was found in the database and the user is authenticated.

The preceding SQL select code looks simple and straightforward. However, the SQL injection problem arises if the user enters nothing for the password and the following in response to the prompt for a user name:

```
any_bogus_name' or 1=1 --
```

The resulting SQL query executed on the database is as follows:

```
select username from users where
  userid='any_bogus_name' or 1=1 -- 'and password = ''
```

As you can see, the bogus user name was inserted into the query, however, the select command will still be successful (authenticating the user) because the user name lookup will be 'or'ed with `1=1` (which is always true). The double dashes (`--`) comment out the remainder of the select statement, thus rendering the password input useless.

Stored procedures

In today's environment, a common security breach occurs when an external or internal user gains access to the network and begins monitoring traffic between the application and the database. This approach can help a hacker learn where key data, such as passwords, are stored. To mitigate this, the application server should not use any direct Structured Query Language (SQL). Instead, when modifications, additions, or deletions of database information are needed, a stored procedure should be used to perform the function. The SQL statements will not have any rights to access data in the tables; only stored procedures will be able to access data. Someone hacking the system could do a SELECT and pull back all of a table's data if SQL were allowed. However, because stored procedures allow data to be retrieved only in the built-in amount, format, and rules, the system would limit the amount of data a hacker could retrieve.

Dynamic scripting

Dynamically executing scripts based on user inputs can be very risky. The onus is put on the developer to check and guard against every possible input that is not expected. Recall the paradigm discussion earlier — the attacker is probably more practiced and creative about thinking up abnormal input. Additionally, the attacker, in many cases, has a lot more time to devote to this one task than does the developer. If possible, dynamic scripting should be disabled at the database level or at the Java environment level. A module developer should not even have the option of using dynamic scripting.

Screen for all unusual input

An attacker will do something you don't expect — count on it. It is easier for a developer to know what the normal action or response to a Web page is than to predict every unusual one. Software developers need to test user input aggressively for normal responses and block everything else. The challenge is to be able to capture normal input in a set of rules that does not give the attacker enough room to abuse the server.

The testing of input from the user must include that absence of expected responses. For example, a POST command sent without POST data may not return from the server. It may or may not be using up server resources. If the TCP connection remains open, there is potential for a denial-of-service (DoS) attack. A common

method of DoS attacks is to initiate hundreds of connections that don't fully complete. The server must keep the half-open connections in memory because the algorithms expect the connection to either be completed or to be reset. When the available memory for new connections fills up, no one else can connect to the server. In some cases, when the memory fills up, the server crashes.

Use encryption

Encryption can go a long way to maintaining the confidentiality of the data in any application. The price for encryption is performance or the cost of additional hardware or software. Additional hardware may be needed to increase the bandwidth and improve the application's performance. The use of encryption is a security control multiplier; it enhances any security posture. Encryption can be used in storage, transmission, or data verification.



Encryption is covered in detail in Chapters 14 and 16.

Using encryption for data storage adds another defense to the defense-in-depth model for a given server application. Data stored encrypted in the database or on the hard drive is protected against a breakdown in physical security, such as a server host being stolen or lost. Encrypted data storage also protects against an attack in which the server's host is compromised and the attacker attempts to access the data directly from the operating system.

Encryption should be used for transmissions anytime sensitive or private data is involved. This would include information such as the following:

- ♦ Names, addresses, and phone numbers
- ♦ Credit card numbers, bank account numbers, and Personal Identification Numbers (PINs)
- ♦ Financial data such as reports, balances, and transactions
- ♦ Salary information
- ♦ Personal information such as shopping carts and wish lists

The two most common means of encrypting during transmission are using Secure Sockets Layer (SSL) and a Virtual Private Network (VPN). SSL encrypts the application's traffic. SSL-compatible clients, such as a Web browser, are readily available, so there is no practical impedance to its use. Using a VPN is a general solution to encryption in which all the network traffic is encrypted and tunneled. Because both ends of the VPN must be compatible and coordinated, it is not a solution for the general public, but rather for a small set of users, such as employees working from home.

Encryption can also be used to verify the integrity of data being transmitted. Consider, for example, the following data that is passed in a cookie from a Web server to a Web browser.

```
SessionID=9si82kjskjwiue092  
ValidUser=Y  
UserID=JohnDoe
```

If this information was encrypted, it might read as follows:

```
SessionData=ks92ieiufjmkw74ujrjfkksdyyuisklfjghsyy3kekksyywks  
11bns29js
```

This would protect the identity of John Doe, in the first cookie. Because the cookie was encrypted by the server, only the server has the key to decrypt the cookie when it is returned from the Web browser.

The cookie's integrity could also be maintained by adding a hash field to the information in the cookie. A hash algorithm can take the data from the original cookie and pass it through a one-way encryption process that produces a short string. Any change in the original cookie would result in a different hash, therefore, the integrity of the cookie data can be verified. After running the original cookie through a hash function, the cookie is now as follows:

```
SessionID=9si82kjskjwiue092  
ValidUser=Y  
UserID=JohnDoe  
Hash=2o29e7jhtw5uedkfhgf73
```

Now, if any of the fields in the cookie are altered, the server will know because the cookie sent back to the server will not hash out to the same value as that stored in the cookie.

The use of encryption and hashing to ensure the privacy and integrity of the information in the cookie adds very little overhead to the overall server application, while providing additional defense in depth.

Web-based applications may be subject to hijacking and replay man-in-the-middle attacks. These attacks can lead to a Web session being overtaken by a third party (hijacking) or transaction being replayed. Using SSL will prevent hijacking and replay attacks under most circumstances.

Encryption can provide an extra measure of security in addition to all the other security controls implemented. The SSL protocol runs above TCP/IP and below higher-level protocols such as HTTP or IMAP. It uses TCP/IP on behalf of the higher-level protocols and in the process allows an SSL-enabled server to authenticate

itself to an SSL-enabled client, allows the client to authenticate itself to the server, and allows both machines to establish an encrypted connection. In general, SSL can be added to an application with little impact on the developers.

The negative impact that SSL can have is on performance and cost. The following is from an SSL FAQ:

How will SSL affect my machine's performance?

The performance problems associated with most HTTP servers are CPU and memory related (this contradicts the common assumption that it is always the network which is the problem). The CPU has to process the HTTP request, write out HTTP headers, log the request and put it all on the TCP stack. Memory bandwidth is also a problem (the operating system has to make a lot of copies to put packets onto the network). SSL makes this bottleneck more severe:

- ♦ **Bandwidth:** SSL adds on average 1K bytes to each transaction. This is not noticeable in the case of large file transfers.
- ♦ **Latency:** SSL with client authentication requires two round trips between the server and the client before the HTTP session can begin. This typically means at least a 500 ms addition to the HTTP service time.
- ♦ **Bulk encryption:** SSL was designed to have RC4 and MD5 in its cipher suite. These run very efficiently on a 32-bit processor.
- ♦ **Key exchange:** This is where most of the CPU bottleneck on SSL servers occurs. SSL has been optimized to require a minimum amount of RSA operations to set up a secure session. Avoid temporary RSA keys, which can cause a massive performance hit.

Netscape has published figures suggesting that the throughput (in hits per second) of an SSL-enabled server is as low as 20 percent of that of an unencrypted server. The greatest performance hit occurs when the server and client exchange handshake messages for authentication and key generation or exchange. These operations are performing computationally intensive public key operations. Subsequent hits use the session restart feature of SSL. This allows the server and client to simply use the previously negotiated secret key.

Test, test, test

A secure design is very important, but no application ends up exactly as designed. It is the very nature of security flaws that they are likely to take advantage of any deviation from the design. Testing is important to both find deviations from design and

to detect any unforeseen flaws that might have been introduced during the development process. Testing is also one of the best ways to provide feedback to designers and planners to improve future requirements. Glaring security concerns that are noticed at testing stand a good chance of being put into future requirements.

Having a 100 percent secure application is a nearly impossible task. Security flaws will be introduced in any development process that is creative and flexible. However, good requirements and testing can minimize the security risk introduced into a creative development process.

You should begin security testing on a new application while it is still on paper. Paper attempts to break the application will surely lead to issues to be address. Later rounds of testing should include source code analyzers to ensure that logical errors are not included in the code. These analyzers can perform pattern matching to identify functions or constructs that are potentially flawed. Finally, after being fully developed, testers should use network sniffers and application-level scanners to verify the operation of the application. The sniffers will allow the testers to examine the low-level packets emanating from the server, looking for flaws such as transmitting passwords in the clear. The scanners will test the server's boundaries and see if it can be coaxed into an unexpected behavior.

There are many ways to visualize requirements testing. Figure 10-2 shows the Testing V used by the Department of Defense (DoD). While this is a complicated figure, it conveys the following principles:

- ♦ Tests should be directly based on the requirements at the same level—high-level tests for high-level requirements.
- ♦ Tests should be written when the requirement is written, but not tested until the application has been developed to that level.
- ♦ Requirements should start at a high level and be refined over time.
- ♦ Requirements should be completely refined before coding.
- ♦ As coding is completed and increasing levels of requirements are satisfied, it should be tested.
- ♦ The final testing will be a high-level user acceptance testing.

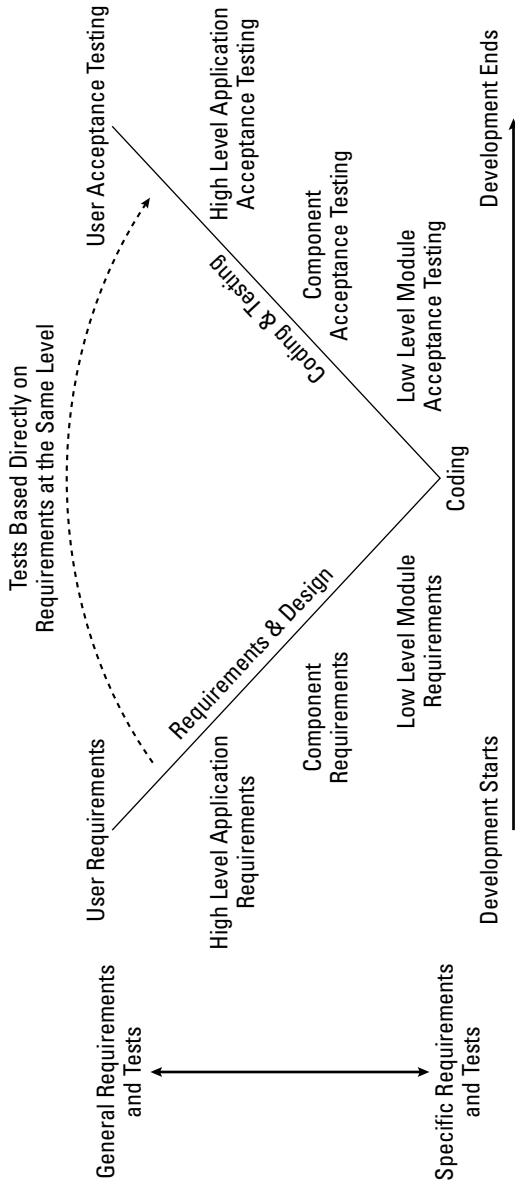

Figure 10-2: Testing V

Operating Servers Safely

Even the most securely developed server application must be placed in a secure operational environment. To operate the server securely, an organization must establish a plan with associated procedures. These procedures should include the following key aspects:

- ♦ **Control the server configuration.** The server must be configured to minimize exposure to an attack. Periodic backups can mitigate the risk if an attack does occur.
- ♦ **Control users and access.** A need-to-know and need-to-access environment should be established regarding the server's data and access.
- ♦ **Monitoring, auditing, and logging.** Security does not stop with deployment of the server. In today's environment, continuous monitoring is required to ensure a server remains safe.

Controlling the server configuration

Operating the server safely extends beyond the key application being served up. The host platform must also be secured. Three important considerations when securing the host system are as follows:

- ♦ Physically secure the system.
- ♦ Minimize the risk to the host system by removing unneeded services.
- ♦ Back up the host system to mitigate the risk in the event that an attack does occur.

Physical security of the system

Any server is vulnerable to an attacker with unlimited time and physical access to the server. Additionally, physical problems could cause the server to have down time. This would be a loss of availability, which is considered one of the key principles of security—to maintain confidentiality, integrity, and availability (CIA). The following should be provided to ensure the availability of the server:

- ♦ Provide an uninterruptible power supply (UPS) unit with surge protection.
- ♦ Provide fire protection to minimize the loss of personnel and equipment.
- ♦ Provide adequate cooling and ventilation.
- ♦ Provide adequate lighting and workspace for maintaining and upgrading the system.
- ♦ Restrict physical access to the server. Unauthorized persons should not get near the server. Even casual contact can lead to outages. The server space

should be locked and alarmed. Any access to the space should be recorded for later evaluation should a problem occur. Inventory should be tightly controlled and monitored.

- ♦ The physical protections listed here should extend to the network cables and other devices (such as routers) that are critical to the server operation.

Minimizing services

As discussed earlier, servers are natural targets for attack. It should be expected that attackers will seek the path of least resistance in an attempt to compromise the server. The attacker will look to break in through any of the services running on the server. For this reason, separation of services is a good security practice.

Separation of services dictates that each major service should be run on its own protected host. If any one service or server is compromised, the others are unaffected. In this way, the damage done is limited to the one server. This mitigates the risk to all the servers.

Most server operating systems will have a number of services enabled or on by default. Care must be taken to ensure that these extraneous services are disabled or even deleted from the system. The following list shows typical services that should be disabled from a host if not needed:

- ♦ **Telnet**— This service transmits data in the clear and should not be used under any circumstances. The secure alternative, Secure Shell (SSH), should be used instead, if needed.
- ♦ **Simple Mail Transfer Protocol (SMTP)**— Mail server applications are frequent targets of attacks and, as a result, the software requires frequent upgrades and updates.
- ♦ **File Transfer Protocol (FTP)**— FTP has a number of vulnerabilities and must be properly configured to be safe.
- ♦ **Finger**— Finger can be used to learn information about a computer system that can then be used to launch other attacks.
- ♦ **Netstat, Sstat**— These services can disclose configuration and usage information.
- ♦ **Chargen, Echo**— These services can be used to launch data-driven attacks and denial-of-service (DoS) attacks.
- ♦ **Domain Name System (DNS)**— This service requires frequent patches and upgrades to be secure.
- ♦ **Remote Procedure Calls (RPC)**— Unless the server application explicitly uses RPC to communicate with other systems, this should be disabled.

System backups

System backups are an important security control to mitigate the risk and damage that can be inflicted by an attack. No matter what steps are taken to prevent an attack, they should still be expected. Therefore, every server and server application should have backups as part of the normal operation of the server.

The frequency of the backup should be determined by the critical nature of the data or service. The determination should be made based on a risk and business impact analysis. Typically, data is backed up on a daily or weekly basis. If the loss of a day's worth of data cannot be tolerated, a zero-down time failover system is usually called for.

Backups can aid in a post attack reconstruction. The compromised system can be compared with the backup to determine which part of the system was attacked. This may also provide insight into the extent of the damage inflicted by the attacker.

Controlling users and access

The operating systems and hosts that run server software are general computing devices. These devices are designed for multiple users running multiple applications. To take a general computing device and make it secure for a particular service, the system administrator must establish a need-to-know environment. Data access should be limited on a need-to-know basis and users should be limited on a need-to-access basis. The basic principle of least privilege is that no user (or developer) should have any more access and control than is needed to perform their functions.

User activity on a server is typically grouped into sessions. Cookies are often used to identify users and maintain session objects. These objects hold information to keep track of user-specific information while a user navigates the site without asking for them to identify themselves at every request from the server. Servers should employ a session timeout feature that will log off users due to inactivity. The user will then be required to re-authenticate to continue using the service.

The session tracking information should also be used to ensure that a user only starts one session at a time. During each logon attempt the server should determine if a session is active. If an active session is detected, further access to the application is denied.

The server should require special access to update and maintain sensitive information. Some system functions and operations may be exceptionally sensitive and require special authorization and annotation. Authorize the transaction by entering the user's user name and password. Each adjustment must be accompanied by an explanation in the comment field.

Passwords

Strong passwords should be required on the servers. (Passwords are addressed in detail in Chapter 3.) Following are guidelines for strong password criteria:

- ♦ The password length should be a minimum of seven characters. The longer the password the more difficult it is to brute force.
- ♦ The passwords should contain some nonalphanumeric characters such as ~!#\$%^&*()_-><./|\. By increasing the alphabet that can be used in a password, the time required to brute force or crack the password is dramatically increased.
- ♦ Dates, names, common words, and reversed names cannot be used.
- ♦ The password should expire in 45 to 90 days. At that time the user will be required to enter a new password.
- ♦ Passwords for any given user cannot be re-used until five password changes have occurred. Users should not be permitted to make five rapid changes of their passwords just to get back to a favorite one. The password list will also check for a number appended to the end of the previous passwords to keep users from trying to trick the system.

Passwords should be stored as encrypted data in the system. In the event of a user forgetting a password, the system administrator should not give it out. Instead, the system administrator should assign the user a temporary password. The user can then log back onto the system and immediately change their password.

Users should be allowed three tries to input the correct user name and password. If the user name and password combination is still incorrect after the third try, the system should lock the user's account. The user should then be required to contact the system administrator to unlock their account.

Monitoring, auditing, and logging

Monitoring, auditing, and logging are critical to detecting attacks on servers and responding quickly. Logging is the act of recording key information about the server and service. The logs can be generated both by the operating system (event logs) and the application. Logs can be useful in reconstructing an attack or incident. However, the greatest benefit of logs is their use when monitoring the server.

Monitoring is the periodic review of the logs and other server information. Monitoring is typically done continuously, hourly, or daily. Continuous monitoring is usually done by a help desk, with watch standers having scrolling logs and other status information at their stations. The watch stander is likely to spot patterns and problems in the logs that a computer might not see. Regular monitoring identifies

points of exposure and incidents of policy and procedural violation, which can then be acted upon. The determination of how much monitoring is required is usually done during an audit.

Auditing is the process of verifying that logging and monitoring is being done according to plan or procedures. Auditing is typically only done quarterly or semi-annually. Audits may also be done if an incident occurs or if there is a major configuration change. The result of an audit is usually a change in the logging and monitoring procedures.

Logging and monitoring is a passive yet effective form of intrusion detection. Consistent monitoring can increase the likelihood of detecting an attack against a server.

Server Applications

The two most popular server applications are Web servers (covered in Chapters 6 and 7) and e-mail servers (Chapter 8). Three more categories of server activity are as follows:

- ♦ **Data sharing server**— This consists mostly of FTP servers, Lightweight Directory Access Protocol (LDAP) servers, and simple NetBIOS shares.
- ♦ **Peer-to-peer information exchange**— In this case, files are transferred directly from client to client, but may at first be coordinated through a central server.
- ♦ **Instant messaging (IM) and Internet relay chat (IRC)**— These client-server applications allow for direct and immediate communication between users.

Data sharing

Data-sharing applications are a natural target for attackers because they often hold an organization's most valuable information and data. The most popular means of sharing files are using NetBIOS (see Chapter 4), FTP servers, and LDAP.

FTP servers

Exchanging files with the public or with unknown users will often involve the use of FTP. Many server operating systems will come with FTP as a means for transferring files to the server. If not locked down, an FTP server can be a point of compromise for the server and network as a whole.

Anonymous FTP is particularly risky and open to various attacks. As the name implies, anyone can transfer files without being authenticated with a password.

When prompted for a user name, the word *anonymous* is provided. When prompted for a password, the user is expected to enter his or her e-mail address. Most FTP sites do not check that the e-mail address is valid or even that the domain in the e-mail matches the domain being used by the user.

Some sites configure their anonymous FTP servers to allow writable areas (for example, to make available incoming or *drop-off* directories for files being sent to the site). If these files can be read by anonymous FTP users, the potential for abuse exists. Abusers often gather and distribute lists describing the locations of vulnerable sites and the information these sites contain. The lists commonly include the names of writable directories and the locations of pirated software; they may also include password files or other sensitive information. These drop-off sites are used as data repositories for the abusers to share information.

Unfortunately, in many cases, system administrators are unaware that this abuse is taking place on their archive. They may be unfamiliar with this type of abuse (and so haven't taken steps to prevent it), or they may think that they have configured the archive to prevent abuse when, in fact, they have not. System administrators at the sites being used to place or pick up items from the drop-off area may also not be aware that their users are participating in this activity.

Finally, an anonymous archive server actually may be misconfigured or compromised. This misconfiguration compromise could, in addition to the abuses previously mentioned, provide someone with the ability to run processes under the User ID (UID) of the FTP daemon. If a file can be placed in the writable area of the anonymous FTP server and this area is also readable, anyone who can connect to the anonymous FTP server can obtain a copy of the file. Specifically, abusers do the following:

- ♦ Store and retrieve information. This information is often placed in unusual or hidden files.
- ♦ Gather information about the availability of sites where the anonymous FTP areas are abused, then compile a comprehensive listing (known as *warez* lists) of the locations.
- ♦ Use this information for personal, commercial, or political gain, or carry out attacks against other individuals or organizations.
- ♦ Abuse a vulnerable archive site for a short span of time and then move on to other sites.
- ♦ Leverage this access or exploit system configuration weaknesses to gain other privileged access.

An FTP server can be run securely, but may require constant monitoring. Following are recommendations to minimize the risk when using an FTP server:

- ◆ Lock down the server's host. The server should not run any other services. If possible, place the server behind a firewall that only permits FTP access to the server. Other hosts on the same network should not consider the FTP server trusted.
- ◆ Turn off the FTP server when it's not actually needed. In many cases, the server's administrator expects one or more users to access the FTP server in a certain window of time. The administrator should let the users know the window of time for which the server will be up so the users can get the files they need.
- ◆ Do not allow anonymous access to the FTP server. Anonymous FTP has a number of vulnerabilities. If anonymous FTP is enabled, any files on the root directory would be available for downloading. Also, Trojan horses and back-door applications might be uploaded, leading to the eventual rooting of the server.
- ◆ If anonymous FTP is required, set up a separate server to handle this traffic. Do not put any sensitive files on the same host as the anonymous FTP server.
- ◆ Turn on extensive logging on all the FTP servers.
- ◆ Closely monitor the logs and activity to the FTP server. Be prepared to stop and isolate the server in the event it exhibits any unusual behavior.

LDAP

LDAP is a directory-access protocol derived from X.500. LDAP runs over TCP/IP or other connection-oriented transfer services. LDAP is defined in RFC2251, "The Lightweight Directory Access Protocol (v3)."

LDAP is similar to a database, but can contain more descriptive information. LDAP is designed to give quick response to high-volume lookups or searches.

LDAP uses a tree structure where each node or object in the tree contains a set of attribute-value data. Each object belongs to one or more object classes, which define the mandatory and optional attributes. The original application of both X.500 and LDAP was to provide a white pages directory service, where most objects in the tree represented people and the tree had a geographic or organizational structure.

The security issue regarding LDAP is one of privacy. The following was one of hundreds of entries returned as a result of a random query on the Pennsylvania State University LDAP server. The only information provided to the server was "c*".

**Note**

The information printed here has been altered to protect the privacy of the returned information.

```

Directory entry for ERIC COAN
Name:          EIC COAN
Last Name:     OAN
Given Name:    RIC
Common Name:   RIC COAN
E-mail:        bc106@psu.edu
Mail ID:       bc106
Mailbox:       bc106@email.psu.edu
Userid:        bc106
EduPerson Principal Name:  ebc106@psu.edu
EduPerson Primary Affiliation:  FACULTY
Address:       237 RECREATION BLDG
UNIVERSITY PARK, PA 16802
Telephone Number:  +1 814 555 1212
Title:         INSTRUCTOR
Administrative Area:  HEALTH & HUMAN DEV
Department:     KINESIOLOGY
Campus:         UNIVERSITY PARK
Office Address:  232 Rec Hall
University Park, PA 16802
Office Phone:   8145551212
Home Phone Number:  8142251212
Home Address:   P.O. Box 456

```

There is a significant amount of information that has been acquired about this person — without even knowing the name to begin with. An attacker could use much of this information in social engineering attacks against this person. A typical social engineering attack consists of calling up a help desk and pretending to be the person. In most cases, if the attacker has enough personal information about the target, the help desk will assist the user and provide account information or even reset a password.

An attacker could very quickly acquire all the data in the LDAP server by running a simple script, as follows:

```

#!/usr/bin/perl -w
use Net::LDAP qw(:all);
my $server = 'ldap.psu.edu';
my $base = 'dc=psu, dc=edu';
my $ldap = new Net::LDAP($server) or die "$@";
$ldap->bind( version => 3 );
for ( my $sn1 = ord('a'); $sn1 <= ord('z'); $sn1++ ) {
    my $c1 = chr($sn1);
    for ( my $sn2 = ord('a'); $sn2 <= ord('z'); $sn2++ ) {
        my $c2 = chr($sn2);
        my $filter = "sn=$c1$c2\*";
        my $mesg = $ldap->search ( base => $base,
                                filter => $filter,
                                ) || die ("Failed on search.$!");
    }
}

```

- ♦ P2P applications consume a lot of network bandwidth. While this probably does not rise to the level of a denial-of-service (DoS) attack, it does impact the logging and monitoring at very large organizations such as universities.
- ♦ P2P applications consume a lot of system and network administrators' time. The questions of legality and bandwidth usage make the P2P issue one that administrators cannot ignore.
- ♦ Most P2P applications are not limited to sharing music and movies. Viruses and Trojan horses can be exchanged, as well. If an attacker can get a Trojan horse to run on a remote machine, they can do anything the user is allowed to do.
- ♦ One of the attractions to sharing files is the ability to share new applications and games. Exchanging applications in this manner makes a security professional cringe. These applications must be assumed to come from dubious persons, with motives unknown, without testing or verification. Users who engage in this behavior might as well set their workstations up on the public sidewalk and put up a big sign advertising free and unfettered access to all their personal files and activities.

Instant messaging and chat

Instant messaging (IM) and Internet relay chat (IRC) are user-to-user communication applications that use an intermediate server. The popular IM forums are America Online (AOL IM or AIM), Yahoo, and Microsoft Subscription Network (MSN). IRC is operated over dozens of servers and is administered and moderated by the server administrators and the IRC community itself.

IM and IRC have certain inherent security risks that should be weighted by users when using these services, including the following:

- ♦ Both IM and IRC send text in the clear so it can be sniffed and captured; this becomes a privacy issue.
- ♦ IM is usually between persons who know each other. However, IRC is most often communication between strangers. Users must be very careful not to fall prey to social engineering attacks, because the motives of strangers are not known.
- ♦ It is common to exchange and run robots (or bots) on IRC clients and servers. Bots can be very useful for administrators, as they manage their servers. However, bots can also be very destructive and are cause for concern for an unsuspecting IRC user. The casual IRC user should be able to operate without the need for any bots, and, therefore, should avoid the temptation to download and run them.
- ♦ IM has the capability to have direct peer-to-peer file transfer. For this to happen, the two clients must exchange IP addresses. Providing your IP address to an untrusted entity may increase your risk of attack.

- ♦ Care should be taken when acquiring IM and IRC clients. Because all these clients are acquired cost free, the means of distribution may not always be controlled. Launching an unsafe application can place all the data and all future transactions on the host at risk. Using the IM and IRC clients requires an inherent trust of the application developers and distributors.
- ♦ Operating IM and IRC through a central server implies a certain amount of trust in the server. All personal and confidential data that is communicated can be captured and used by third parties with or without the knowledge of the server's administrators.

Summary

Servers are favorite targets for attackers. Servers have the advantage of being widely used (so the attacker can concentrate their efforts) and accessible by the attacker. Additionally, the attacker knows that servers are likely to hold a wealth of data that can be exploited.

The problems with insufficient security in software applications are magnified by the development of server applications. Security should be incorporated into a server application from the very beginning in the software requirements. If security must be retrofitted into an application, it will be very expensive and not completely effective. Additionally, software development organizations should spend more time and effort testing the application before releasing it to customers. It is all too common that performance is tested by the developers, but security is tested by the general public.



Network Security Fundamentals

P A R T

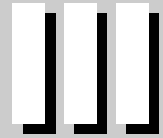

In This Part

Chapter 11
Network Protocols

Chapter 12
Wireless Security

Chapter 13
Network Architecture
Fundamentals



Network Protocols

For entities to communicate, they must agree upon a message format and define common practices for exchanging these messages. Computers and networks are no exception.

This chapter introduces layered communication models and explains the principal protocols used under these models for communication among computers.

Protocols

The word protocol has a number of definitions, based on the context of its use. In diplomacy, for example, a protocol can mean an agreement incorporating the results of a particular stage of a negotiation. In the area of computer communications, a *protocol* is a formal set of rules that describe how computers transmit data and communicate across a network. The protocol defines the message format and the rules for exchanging the messages.

Because of the complexity and multiple functions required to initiate, establish, conduct, and terminate communications among computers on a network, these functions are divided into manageable, individual layers. This decomposition is known as a *layered architecture*.

In a layered architecture, the protocols are arranged in a stack of layers in which data is passed from the highest layer to the lowest layer to effect a transmission. The process is reversed at the receiving end of the transmission, and the data is passed from the bottom of the stack to the top of the stack.

The protocols and standards supported in each of the layers perform specific functions and attach information to the data

11

C H A P T E R



In This Chapter

Reviewing the need for protocols

Understanding the seven-layer OSI model

Understanding the TCP/IP protocol

Discussing address resolution



as it passes through a particular layer. Thus, on the transmitting end, the data packet traverses the stack from the highest level to the lowest level, and each layer adds information as the data passes through. This process is called *data encapsulation*.

At the receiving computer, the process is reversed and the successive layers of information are stripped as the packet traverses the stack up to the highest layer. Each protocol detaches and examines only the data that was attached by its protocol counterpart at the transmitting computer.

The layers in the model range from providing application-oriented processes at the highest level to the generation of electrical or optical signals that are injected into the transmission medium, such as wires, optical fiber, or through the air, in the bottom layer. The intermediate layers perform additional functions, including setting up the communications session, transferring data, and detecting errors.

The Open Systems Interconnect Model

The Open Systems Interconnect (OSI) model was developed circa 1981 by the International Standards Organization (ISO). The OSI model comprises seven functional layers, which provide the basis for communication among computers over networks.

The seven layers of the OSI model, from highest to lowest, are Application, Presentation, Session, Transport, Network, Data Link, and Physical (you can easily remember them, using the mnemonic phrase *All People Seem To Need Data Processing*). Table 11-1 lists these layers, their general functions, and corresponding protocols, services, or standards.

Table 11-1
ISO OSI Seven Layer Model

<i>Layer</i>	<i>Function</i>	<i>Protocols or Standards</i>
Layer 7: Application	Provides services such as e-mail, file transfers, and file servers	FTP, TFTP, DNS, SMTP, SFTP, SNMP, RLogin, BootP, MIME
Layer 6: Presentation	Provides encryption, code conversion, and data formatting	MPEG, JPEG, HTTP, TIFF
Layer 5: Session	Negotiates and establishes a connection with another computer	SQL, X- Window, ASP, DNA SCP, NFS, RPC

<i>Layer</i>	<i>Function</i>	<i>Protocols or Standards</i>
Layer 4: Transport	Supports reliable end-to-end delivery of data	TCP, UDP, SPX
Layer 3: Network	Performs packet routing across networks	IP, OSPF, ICMP, RIP, ARP, RARP
Layer 2: Data link	Provides error checking, and transfer of message frames	SLIP, PPP, MTU
Layer 1: Physical	Interfaces with transmission medium and sends data over the network	EIA RS-232, EIA RS-449, IEEE 802

The OSI Layers

The following sections discuss each of the OSI layers in turn, explaining their individual functions and the protocols they employ.

The Application layer

Layer 7, the Application layer, is the interface to the user and provides services that deal with the communication portion of an application. It identifies the desired recipient of the communication and ensures that the recipient is available for a transmission session. Protocols associated with the Application layer include the following:

- ♦ **File Transfer Protocol (FTP)**— Provides for authenticated transfer of files between two computers and access to directories; it cannot execute a remote file as a program.
- ♦ **Trivial File Transfer Protocol (TFTP)**— Reduced version of FTP; does not provide authentication or accessing of directories.
- ♦ **Domain Name Service (DNS)**— A distributed database system that matches host names to IP addresses and vice versa. A popular DNS implementation is the Berkeley Internet Name Domain (BIND).
- ♦ **Simple Mail Transfer Protocol (SMTP)**— Supports the transmission and reception of e-mail.
- ♦ **Secure File Transfer Protocol (SFTP)**— A protocol that is replacing FTP. It provides increased security because it includes strong encryption and authentication. FTP is a client that is similar to FTP and uses SSH or SSH-2 to provides secure file transfer.

- ♦ **Simple Network Management Protocol (SNMP)**— Supports the exchange of management information among network devices through a management entity that polls these devices. It is a tool for network administrators used to manage the network and detect problem areas.
- ♦ **Remote login (Rlogin)**— A command in UNIX that begins a terminal session between an authorized user and a remote host on a network. The user can perform all functions as if he or she were actually at the remote host. Rlogin is similar to the Telnet command.
- ♦ **BootP**— Provides a diskless workstation with its IP address based on its MAC address; this information comes from a BootP server.
- ♦ **Multipurpose Internet Mail Extensions (MIME)**— Enables the use of non-US-ASCII textual messages, nontextual messages, multipart message bodies, and non-US-ASCII information in message headers in Internet mail.

The Presentation layer

Layer 6, the Presentation layer, is so named because it presents information to the Application layer. Layer 6 performs encryption, decryption, compression, and decompression functions, as well as translating codes such as Extended Binary-Coded Decimal Interchange Code (EBCDIC) or American Standard Code for Information Interchange (ASCII). Standards associated with Layer 6 include the following:

- ♦ **Motion Picture Experts Group (MPEG)**— The Motion Picture Experts Group's standard for the compression and coding of motion video.
- ♦ **Joint Photographic Experts Group (JPEG)**— Standard for graphics defined by the Joint Photographic Experts Group.
- ♦ **Hypertext Transfer Protocol (HTTP)**— A protocol used for sending Web pages and information to other locations on the Internet.
- ♦ **Tagged Image File Format (TIFF)**— A public domain raster file graphics format. It does not handle vector graphics. TIFF is platform independent and was designed for use with printers and scanners.

The Session Layer

Layer 5, the Session layer, provides services to Layer 4, the Transport layer, to support applications. It sets up the lines of communication with other computers, manages the dialogue among computers, synchronizes the communications between the transmitting and receiving entities, formats the message data, and manages the communication session in general.

The functions of Layer 5 are summarized as follows:

- ♦ Establishing the connection
- ♦ Transferring data
- ♦ Releasing the connection

Session layer protocols include the following:

- ♦ **Structured Query Language (SQL)**—An application that supports multiple queries to the SQL database. SQL is a standardized language for obtaining information from a database. When applied to the Internet, it enables multiple users to log in to the Internet simultaneously.
- ♦ **X-Window System**—Supports developing graphical user interface applications.
- ♦ **Appletalk Session Protocol (ASP)**—Used to set up a session between an ASP server application and an ASP workstation application or process.
- ♦ **Digital Network Architecture Session Control Protocol (DNA SCP)**—A layered network architecture developed by Digital Equipment Corporation (DEC). DNA supports a number of protocols, including the Session Control Protocol. SCP translates names to addresses, sets up logical links, receives logical-link requests from end devices, accepts or rejects logical-link requests, and terminates logical links.
- ♦ **Network File System (NFS)**—Supports the sharing of files among different types of file systems.
- ♦ **Remote Procedure Call (RPC)**—Supports procedure calls where the called procedure and the calling procedure may be on different systems communicating through a network. RPC is useful in setting up distributed, client-server-based applications.

The Transport layer

Layer 4, the Transport layer, maintains the control and integrity of a communications session. It delineates the addressing of devices on the network, describes how to make internode connections, and manages the networking of messages. The Transport layer also reassembles data from higher-layer applications and establishes the logical connection between the sending and receiving hosts on the network. The protocols of the Transport layer are as follows:

- ♦ **Transmission Control Protocol (TCP)**—A highly reliable, connection-oriented protocol used in communications between hosts in packet-switched computer networks or interconnected networks. It guarantees the delivery of packets and that the packets will be delivered in the same order as they were

sent. There is a large overhead associated with sending packets with TCP because of the tasks it has to perform to ensure reliable communications.

- ♦ **User Datagram Protocol (UDP)**—An “unreliable” protocol in that it transmits packets on a best effort basis. It does not provide for error correction or for the correct transmission and reception sequencing of packets. Because of its low overhead, it is well suited for streaming video/audio applications.
- ♦ **Sequenced Packet Exchange (SPX)**—A protocol maintained by Novell, Inc. that provides a reliable, connection-oriented transport service. It uses the Internetwork Packet Exchange (IPX) protocol to transmit and receive packets.

The Network layer

Layer 3, the Network layer, sets up logical paths or virtual circuits for transmitting data packets from a source network to a destination network. It performs the following functions:

- ♦ Switching and routing
- ♦ Forwarding
- ♦ Addressing
- ♦ Error detection
- ♦ Node traffic control

The Network layer protocols include the following:

- ♦ **The Internet Protocol (IP)**—Provides a best effort or unreliable service for connecting computers to form a computer network. It does not guarantee packet delivery. A computer on the network is assigned a unique IP address. The transmitted data packets contain the IP addresses of the sending and receiving computers on the network, in addition to other control data. The data packets or *datagrams* traverse networks through the use of intermediate routers that check the IP address of the destination device and forward the datagrams to other routers until the destination computer is found. Routers calculate the optimum path for data packets to reach their destination.
- ♦ **Open Shortest Path First (OSPF)**—A shortest path first (SPF) protocol that selects the least cost path from a source computer to a destination computer.
- ♦ **Internet Control Message Protocol (ICMP)**—A client server application protocol used to identify problems with the successful delivery of packets within an IP network. It can verify that routers are properly routing packets to the destination computer. A useful ICMP utility is the PING command, which can check if computers on a network are physically connected.

- ♦ **Routing Information Protocol (RIP)**— A protocol that sends routing update messages to other network routers at regular intervals and when the network topology changes. This updating ensures the RIP routers select the least-cost path to a specified IP address destination.
- ♦ **Address Resolution Protocol (ARP)**— A protocol that maps IP network addresses to the hardware Media Access Control (MAC) addresses used by a data link protocol. Every computer is assigned a unique MAC address by the manufacturer. A MAC address comprises a 6-byte, 12 Hexadecimal digit number. The first three bytes of a MAC address identify the manufacturer. For example, the Hex number 00AA00 would indicate that Intel is the manufacturer. The ARP protocol functions as a portion of the interface between the OSI network and link layers. The remaining three bytes represent the serial number of the device.
- ♦ **Reverse Address Resolution Protocol (RARP)**— A protocol that enables a computer in a local area network (LAN) to determine its IP address based on its MAC address. RARP is applicable to Token Ring, Ethernet, and Fiber Distributed-Data Interface LANs.

The Data Link layer

Layer 2, the Data Link layer, encodes the data packets to be sent into bits for transmission by the Physical layer. Conversely, the data packets are decoded at Layer 2 of the receiving computer. Layer 2 also performs flow control, protocol management, and Physical layer error checking. It is also the layer that implements bridging.

The Data Link layer is divided into sublayers: the Media Access layer and the Logical Link layer.

The Media Access layer performs the following functions:

- ♦ Supports the network computer's access to packet data
- ♦ Controls the network computer's permission to transmit packet data

The Logical Link layer performs the following functions:

- ♦ Sets up the communication link between entities on a physical channel
- ♦ Converts data to be sent into bits for transmission
- ♦ Formats the data to be transmitted into frames
- ♦ Adds a header to the data that indicates the source and destination IP addresses
- ♦ Defines the network access protocol for data transmission and reception

- ♦ Controls error checking and frame synchronization
- ♦ Supports Ethernet and Token Ring operations

Data Link layer protocols include the following:

- ♦ **Serial Line Internet Protocol (SLIP)**—A protocol that defines a sequence of characters that frame IP packets on a serial line. It is used for point-to-point serial connections running TCP/IP, such as dial-up or dedicated serial lines.
- ♦ **Point-to-Point Protocol (PPP)**—A protocol that supports a variety of other protocols for transmitting data over point-to-point links. It does this by encapsulating the datagrams of other protocols. PPP was designed as a replacement for SLIP in sending information using synchronous modems. IP, IPX, and DECnet protocols can operate under PPP. Some subprotocols and terms of PPP used in accomplishing its functions are as follows:
 - **Link Control Protocol**—A protocol that detects loopback links, accommodates limits on packet sizes, sets up encapsulation options, and optionally performs peer-to-peer authentication.
 - **Network Control Protocol**—A protocol for configuring, managing, and testing data links.
 - **Maximum Transmission Unit (MTU)**—A limitation on the maximum number of bytes of data in one transmission unit, such as a packet. Ethernet, for example, specifies an MTU of 1,516 bytes.
 - **Packet Fragmentation**—Dividing a packet that is too large to be transmitted as a single entity. The packet is then said to be *fragmented* and is recombined at the receiving destination. Processing fragmented packets consumes resources that might be needed for normal message processing.

The Physical layer

Layer 1, the Physical layer, transmits data bits through the network in the form of light pulses, electrical signals, or radio waves. It includes the necessary software and hardware to accomplish this task, including appropriate cards and cabling, such as twisted pair or coaxial cables. In addition to electronic interfaces, the Physical layer is also concerned with mechanical issues such as cable connectors and cable length. Standard Physical layer interfaces include Ethernet, FDDI, Token Ring, X.21, EIA RS-232, and RS-449. This level is addressed in the family of IEEE 802 LAN/WAN standards, which include the following areas:

- ♦ **802.1**—Internetworking
- ♦ **802.2**—Logical Link Control
- ♦ **802.3**—Ethernet (CSMA/CD)

- ♦ **802.3u** — Fast Ethernet
- ♦ **802.3z** — Gigabit Ethernet
- ♦ **802.3ae** — 10 Gigabit Ethernet
- ♦ **802.4** — Token Bus
- ♦ **802.5** — Token Ring
- ♦ **802.7** — Broadband Technology
- ♦ **802.8** — Fiber Optic Technology
- ♦ **802.9** — Voice/Data Integration (IsoEnet)
- ♦ **802.10** — LAN Security
- ♦ **802.11** — Wireless Networking
- ♦ **802.15** — Wireless Personal Area Network
- ♦ **802.16** — Wireless Metropolitan Area Networks

The TCP/IP Model

The Transmission Control Protocol (TCP) and Internet Protocol (IP) were developed in the 1970s, prior to the ISO OSI model. TCP and IP are part of a layered protocol model that is similar, but not identical to the OSI model. In fact, the OSI model incorporated some of the concepts of TCP/IP. The goal of TCP/IP was to enable different types of computers on different geographical networks to communicate reliably, even if portions of the connecting links were disabled. TCP/IP grew out of research by the U.S. Department of Defense (DoD) to develop systems that could communicate in battlefield environments where communication links were likely to be destroyed. The solution was to send messages in the form of packets that could be routed around broken connections and reassembled at the receiving end. TCP/IP provides this functionality through programs called *sockets* used to access the TCP/IP protocol services.

In the TCP/IP model, TCP verifies the correct delivery of data and provides error detection capabilities. If an error is detected, TCP effects the retransmission of the data until a valid packet is received. This function is based on an acknowledgment that should be sent back to the transmitting computer upon the receipt of delivered packets. If a packet is not acknowledged, the originating computer resends it. The receiving computer then organizes the received packets into their proper order.

The IP portion of TCP/IP is responsible for sending packets from node to node on the network until it reaches its final destination. It routes the information from a computer to an organization's enterprise network, and from there, to a regional network and, finally, the Internet.

The routing is accomplished through an IP address that is assigned to every computer on the Internet. This IP address is the four-byte destination IP address that is included in every packet. It is usually represented in decimal form as octets of numbers from 0 to 255, such as 160.192.226.135. For example, 255.255.255.255 is used to broadcast to all hosts on the local network. An IP address is divided into a portion that identifies a network and another portion that identifies the host or node on a network. Additionally, a network is assigned to a Class from A through E and this class representation further delineates which part of the address refers to the network and which part refers to the node. Classes A through C are the commonly used categories. The network classes and their corresponding addresses are given in Table 11-2.

Table 11-2
IP Address Network Classes

<i>Class</i>	<i>Network Address</i>	<i>Host Address</i>	<i>Example Address</i>
Class A Address range = 1.0.0.1 to 126.255.255.254	First 8 bits define network address. Binary address always begins with 0, therefore, the decimal address ranges from 1 to 126. (127 networks)	Remaining 24 bits define host address. (16 million hosts)	110.160.212.156 Network = 110 Host = 160.212.156
Class B Address range = 128.1.0.1 to 191.255.255.254	First 16 bits define network address. Binary address always begins with 10, therefore, the decimal address ranges from 128 to 191. (# 127 is reserved for loopback testing on local host.) (16,000 networks)	Remaining 16 bits define host address. (65,000 hosts)	168.110.226.155 Network = 168.110 Host = 226.155
Class C Address range = 192.0.1.1 to 223.255.254.254	First 24 bits define network address. Binary address always begins with 110, therefore, the decimal address ranges from 192 to 223. (2 million networks)	Remaining 8 bits define host address. (254 hosts)	200.160.198.156 Network = 200.160.198 Host = 156

<i>Class</i>	<i>Network Address</i>	<i>Host Address</i>	<i>Example Address</i>
Class D Address range = 224.0.0.0 to 239.255.255.255	Binary address always begins with 1110, therefore, the decimal address ranges from 224 to 239.	Reserved for multicasting	
Class E Address range = 240.0.0.0 to 254.255.255.254	Binary addresses start with 1111, therefore, the decimal number can be anywhere from 240 to 255.	Reserved for experimental purposes	

TCP/IP Model Layers

The TCP/IP model comprises four layers: the Application layer, the Host-to-Host layer or Transport layer, the Internet layer, and the Network Access layer. These layers and their corresponding functions and protocols are summarized in Table 11-3.

Table 11-3
TCP/IP Model Layers

<i>Layer</i>	<i>Function</i>	<i>Protocols or Standards</i>
Layer 4: Application	Equivalent to Application, Presentation, and Session layers of the OSI model. In TCP/IP, an application is a process that is above the Transport layer. Applications communicate through sockets and ports.	SMTP, POP, HTTP, FTP
Layer 3: Host-to-Host or Transport Layer	Similar to the OSI Transport layer; performs packet sequencing, supports reliable end-to-end communications, ensures data integrity, and provides for error-free data delivery.	TCP, UDP
Layer 2: Internet Layer	Isolates the upper-layer protocols from the details of the underlying network and manages the connections across the network. Uses protocols that provide for logical transmission of packets over a network and controls communications among hosts; assigns IP addresses to network nodes.	IP, ARP, RARP, ICMP

Continued

Layer	Function	Protocols or Standards
Layer 1: Network Access Layer	Combines the Data Link layer and Physical layer functions of the OSI model. These functions include mapping IP addresses to MAC addresses, using software drivers, and encapsulation of IP datagrams into frames to be transmitted by the network. It is also concerned with communications hardware and software, connectors, voltage levels, and cabling.	EIA RS-232, EIA RS-449, IEEE 802

As with the OSI model, encapsulation occurs as data traverses the layers from the Application layer to the Network Access layer at the transmitting node. This process is reversed in the receiving node. Encapsulation in TCP/IP is illustrated in Figure 11-1.

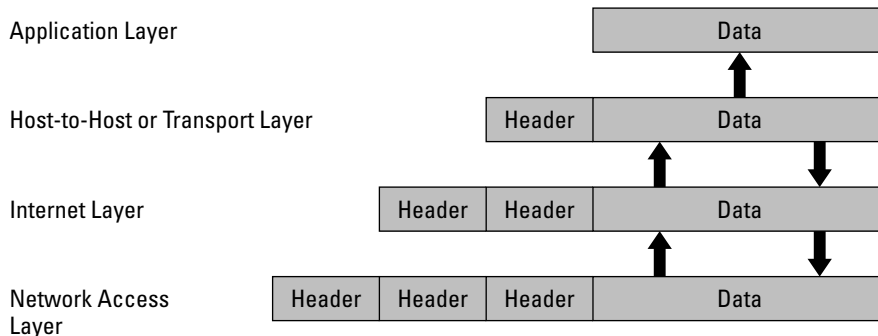

Figure 11-1: TCP/IP Encapsulation.

The example protocols listed in Table 11-3 have been discussed under the OSI model, except for the Post Office Protocol (POP). Using POP, an e-mail client can retrieve e-mail from a mail server. The latest version of POP is POP3 and can be used with or without SMTP. A security issue with POP3 is that the password used for authentication is transmitted in the clear.

Network Address Translation

Network Address Translation (NAT), described in RFC 1631, performs the function of converting a private IP address that is inside a trusted network to a registered IP address seen by an outside, untrusted network. Thus, a private IP address is hidden and is not seen as the source IP address in a packet sent from a computer in the private network. To accomplish this act of hiding, each incoming or outgoing packet is converted by NAT. NAT then enables an organization to use one IP address for its communications with outside networks.

To support NAT, the Internet Assigned Numbers Authority (IANA) has reserved three blocks of the IP address space for private Internets. These IP addresses are 10.0.0.0 to 10.255.255.255, 172.16.0.0 to 172.31.255.255, and 192.168.0.0 to 192.168.255.255.

Summary

The ISO OSI seven-layer architecture encompasses the protocols required for reliable computer-to-computer communications. The earlier TCP/IP family of protocols is the basis for Internet and intranet communications and serve as a common standard for communication among a variety of platforms and operating systems.

The protocols that define the OSI and TCP/IP models provide a rich source of mechanisms for achieving effective and reliable digital communications.



Wireless Security

Wireless cellular technology has made the cellular phone a must-have accessory that enables us to instantly communicate with friends, relatives, and business associates. Similarly, computers can also be free of wired connections when they are part of a wireless local area network (LAN) network. However, with this increased freedom comes increased risk of information compromise, particularly in wireless LANs.

This chapter explains cellular phone and wireless LAN technologies and addresses the associated wireless network security vulnerabilities and safeguards.

Electromagnetic Spectrum

Prior to exploring the details of cellular phones and wireless LANs, a review of some fundamental terminology might be helpful. In wireless technology, the information is transmitted through the air similar to radio signal transmissions. The transmitted waves can be described in terms of a sine wave, as shown in Figure 12-1. The important definitions associated with a sine wave are as follows:

- ◆ **Period and wavelength**—The *period* of a sine wave is defined as the time elapsed from one reference point on the sine wave to the next nearest identical point as the sine wave repeats. This distance is called the *wavelength* of the sine wave. The wavelength is denoted by the Greek letter lambda, λ , measured in units of length, such as feet, inches, or Angstroms. As shown in Figure 12-1, one Angstrom = 10^{-10} meters. The period is measured in units of time such as milliseconds or seconds, and the sine wave is said to have gone through one *cycle* in a period.

12

CHAPTER



In This Chapter

Understanding the electromagnetic spectrum

Understanding wireless transmission systems

Defining the generations of wireless technologies

Reviewing spread spectrum technology

Understanding 802.11 wireless LAN specifications and security

Discussing the Wireless Application Protocol

Exploring personal area networks



- ♦ **Frequency**—The number of sine wave cycles that occur in one second is called the *frequency* of the sine wave, which is measured in cycles per second or Herz. Thus, a sine wave that makes 1000 cycles in a second is said to have a frequency of 1000 cycles per second, 1000 Herz, or 1 kiloHerz.
- ♦ **Relationship**—The relationship between the frequency of a sine wave and its wavelength is given by the formula, $f = c / \lambda$, where f is the frequency in cycles per second, c is the speed of light constant (3×10^{10} cm/sec), and λ is the wavelength in cm.

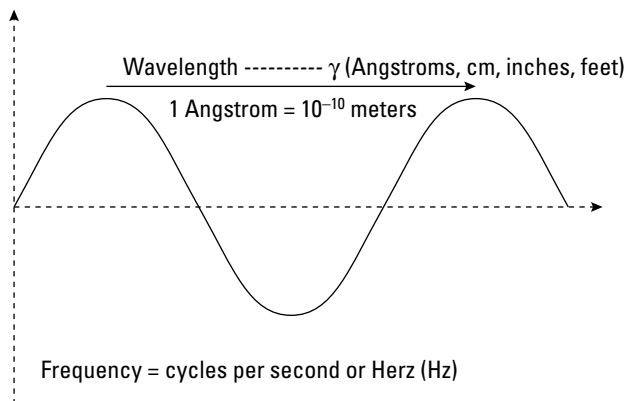

Figure 12-1: Sine wave characteristics

The electromagnetic spectrum is the range of frequencies characteristic of different applications and natural phenomena, as shown in Figure 12-2.

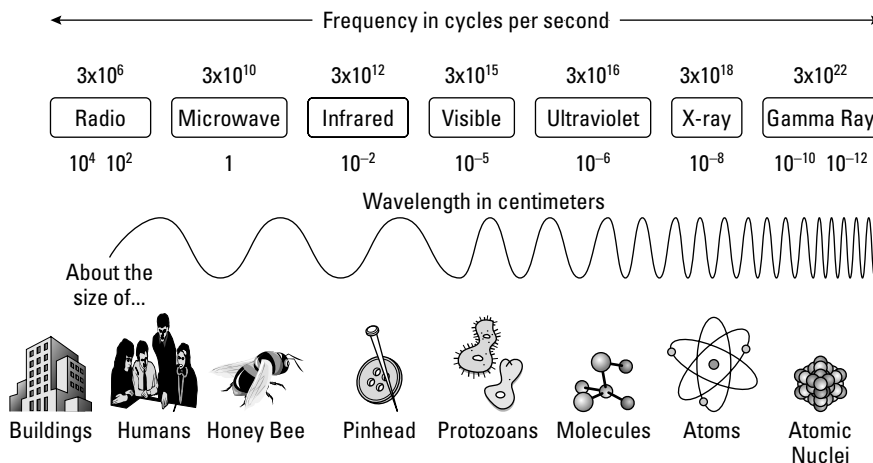

Figure 12-2: The electromagnetic spectrum

The cellular phone and wireless LAN networks operate in the Ultra-High Frequency (UHF) band. The UHF band is shown relative to other frequency bands in Figure 12-3.

• 10 kHz to 30 kHz	Very Low Frequency (VLF)
• 30 kHz to 300 kHz	Low Frequency (LF)
• 300 kHz to 3 MHz	Medium Frequency (MF)
• 3 MHz to 30 MHz	High Frequency (HF)
• 30 MHz to 144 MHz	} Very High Frequency (VHF)
• 144 MHz to 174 MHz	
• 174 MHz to 328.6 MHz	
• 328.6 MHz to 450 MHz	
• 450 MHz to 470 MHz	} Ultra High Frequency (UHF)
• 470 MHz to 806 MHz	
• 806 MHz to 960 MHz	
• 960 MHz to 2.3 GHz	
• 2.3 GHz to 2.9 GHz	
• 2.9 GHz to 30 GHz	
• 30 GHz and above	Extremely High Frequency (EHF)

Figure 12-3: UHF and other frequency bands

The Cellular Phone Network

The cellular telephone network comprises a variety of components to effect a connection from one mobile unit to another. These components have to recognize a mobile phone, verify that it is a “legal” phone, note its location, retrieve information about the phone’s account, establish the connection, generate billing information, and so on. The cellular network components that accomplish these tasks are summarized as follows:

- ♦ **Mobile station** — The mobile phone or mobile equipment, uniquely identified by the International Mobile Equipment Identity (IMEI). The IMEI consists of a six-digit Type Approval Code (TAC), a two-digit Final Assembly Code (FAC), and a six-digit Serial Number (SNR).
- ♦ **International Mobile Subscriber Identity (IMSI)** — A unique identifier assigned to a mobile subscriber that comprises a 15-digit maximum word containing a Mobile Country Code (MCC), a Mobile Network Code (MNC), and a Mobile Station Identification Number (MSIN). The IMSI is independent of the IMEI to provide for user mobility.
- ♦ **Subscriber identity module (SIM)** — A smart card that plugs into the mobile station to provide user mobility. The SIM card can plug into any mobile terminal and enable the user to make and receive calls from that terminal. The SIM

card holds a secret key for authentication purposes and the IMSI. SIM card security is provided through the use of a PIN number or password.

- ♦ **Electronic Serial Number (ESN)**— A 32-bit unique identifier assigned to a mobile station by its manufacturer. Used in equipment prior to the adoption of the IMEI.
- ♦ **Cell tower**— The cellular communication facility that covers one hexagonal-shaped geographic area or cell. The cellular network is divided into cells that are each covered by a cell tower.
- ♦ **Base transceiver station (BTS)**— Incorporates the radio transceivers for a particular cell and communicates with the mobile station.
- ♦ **Base station controller (BSC) or base station**— Controls a cluster of cell towers. It manages the cellular call initiation and controls the transfer of the call from one cell tower boundary to the next when the mobile station moves across these boundaries. The BSC manages the radio capabilities for multiple BTSs and provides the connection from the mobile stations to the mobile switching center.
- ♦ **Mobile switching center (MSC)**— The point to which the base stations connect. The MSC transmits and receives the communications among subscribers on the cellular network, including connections to fixed networks. It also provides additional services, including mobile station registration, authentication, roaming, and routing for mobile subscribers. To accomplish these functions, the MSC connects to the following cellular network components:
 - **Home location register (HLR)**— Tracks subscriber information and maintains a record of the last time the mobile cell phone was registered on the network. It contains account information of each registered subscriber on the network and tracks the current location of the mobile station. The HLR maintains all the necessary information for initiating, terminating, or receiving a call.
 - **Visitor location register (VLR)**— Stores a subset of information contained in the HLR for each mobile station currently in the geographical area controlled by the VLR. For a roaming user, the VLR obtains this information from the user's HLR. Thus, the VLR maintains temporary user information to manage requests for subscribers who are out of their home area.
 - **Authentication center (AuC)**— Uses a protected database to authenticate and validate services for each mobile device attempting to use the network. The authentication is accomplished through the use of a copy of a subscriber's SIM card secret key that is stored in the AuC database. The secret key can also be used for encryption of communications over the radio channel.
 - **Equipment identity register (EIR)**— A database employed within mobile networks that contains a list of all valid mobile equipment on the network, based on the IMEI. If a mobile station has been stolen or is of a type that is not approved for the network, its IMEI will be tagged as invalid.

The topology of these major network cellular components is illustrated in Figure 12-4.

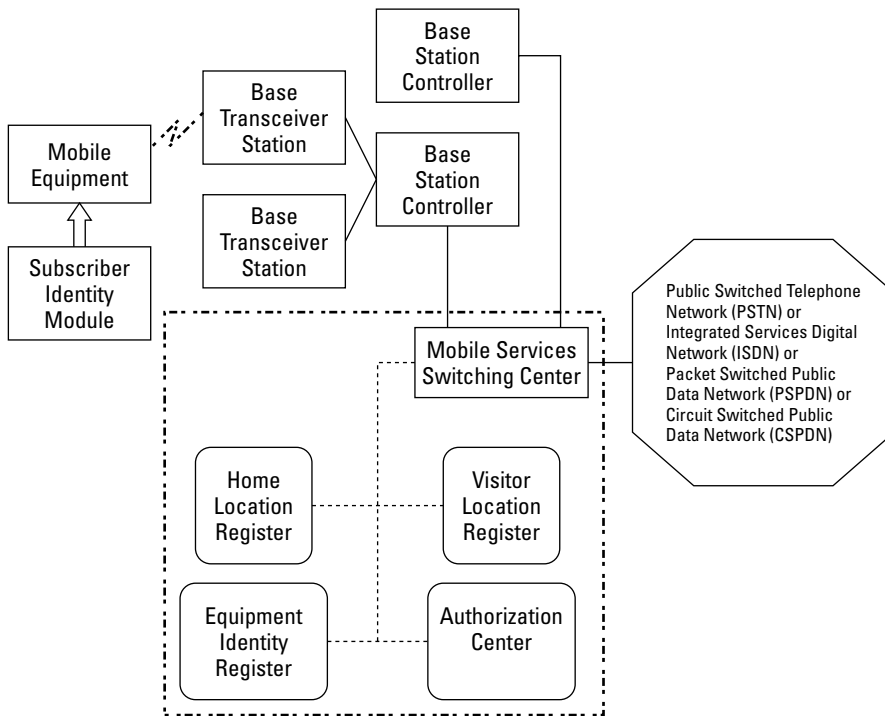

Figure 12-4: The major cellular network components

Placing a Cellular Telephone Call

The sequence of events for placing a cellular phone call, involving the cellular network components, is as follows:

1. The mobile station radio transceiver transmits a message request to the nearest base station.
2. The base station receives the call signal and sends it to the mobile switching center.
3. The mobile switching center queries the home location register to determine if the call is being placed to another mobile station within the local cell or if it is a roaming call. If it is the latter, the mobile switching center accesses the visitor location register.
4. The mobile switching center queries the equipment identity register and authentication center for location, service qualification, features, and authentication.

5. If everything is in order, the call is routed to the same base station, another base station, the Internet, or a land line.

Wireless Transmission Systems

A number of wireless technologies are in use globally, most of which are not compatible with the others. Wireless networks have evolved from analog-based equipment to sophisticated digital devices. In addition, efforts are in place to develop a global standard so that wireless equipment will be able to operate internationally. As wireless technologies improved, they were categorized into generations, using a number and the letter G. For example, first generation technology is labeled 1G, second generation 2G, and so on. This section discusses the different types of wireless transmission system technologies and their evolution through a number of generations.

Before describing the different wireless transmission systems, three important technologies used in these systems are presented. These technologies are Time Division Multiple Access (TDMA), Frequency Division Multiple Access (FDMA), and Code Division Multiple Access (CDMA).

Time Division Multiple Access

TDMA is a digital transport mechanism that provides for multiple channels over the same medium by allotting a time slot for each conversation. Thus, user 1 can use the medium for a fixed period of time, then user 2, then user 3, and so on, until the cycle repeats. The TDMA concept is widely used in 2G wireless systems and is illustrated in Figure 12-5.

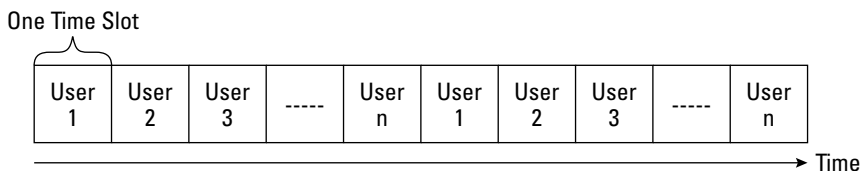

Figure 12-5: TDMA operation

Frequency Division Multiple Access

FDMA is technology wherein multiple calls are made by assigning each call to a separate frequency or channel. Because the calls are on different frequencies, they can be separated at the receiving end. In full duplex FDMA, in which communication can occur simultaneously in both directions, separate channels are required for transmitting and receiving. FDMA is used in 1G analog systems. FDMA is shown in Figure 12-6.

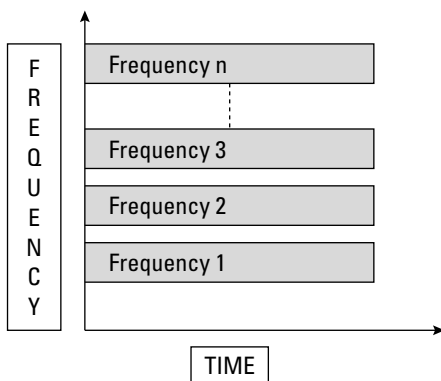

Figure 12-6: FDMA operation

Code Division Multiple Access

CDMA uses codes to distinguish among simultaneously transmitted signals. One instantiation of CDMA is spread spectrum technology, which spreads the transmitted information over a wider bandwidth than conventional systems. This spreading provides for increased immunity to noise interference and jamming. To send multiple messages over the spread spectrum, unique codes are assigned to each call at the transmitting end. The receiver then uses one of the assigned unique codes to decode a call and distinguish it from the other overlaid calls. The principal radio interface for 3G wireless systems, specifically IMT-2000, is a 3-mode, wideband version of CDMA. The CDMA scheme is shown in Figure 12-7.

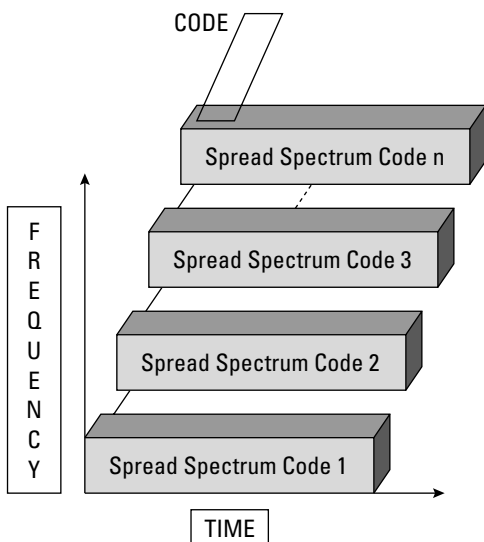

Figure 12-7: CDMA operation

Wireless transmission system types

The application of TDMA, FDMA, and CDMA technologies to mobile phone systems is discussed in the following sections.

Advanced mobile phone system

The advanced mobile phone system (AMPS) is a first generation analog wireless technology family of standards and is the U.S. standard for analog cellular service. The AMPS standards were developed by the TR-45 committee within the Telecommunications Industry Association (TIA). AMPS uses FDMA and operates in the 800-MHz frequency band using 30 kHz wide channels. Another version of AMPS, N-AMPS, uses 10 kHz wide channels and offers three times the capacity of conventional AMPS. AMPS is being replaced by the fast-growing digital networks. When used with a modem, AMPS can provide circuit-switched data communications.

A version of AMPS, called D-AMPS, for digital cellular AMPS, was implemented in the TIA IS-54 standard. The next generation standard, TIA/EIA-136, divides a 30kHz cellular channel into three time slots of 8kbps each for three users.

Global System for Mobile Communications

The Global System for Mobile Communications (GSM) is a version of TDMA that operates in the 1800 MHz range, providing 8 time slots in 200 kHz-wide channels. GSM is very popular in Europe and is widely deployed. Wireless networks that operate in the 1800 or 1900 MHz frequency band are also Personal Communications Systems (PCS). A version of GSM TDMA cellular is known as PCS1900.

Cellular digital packet data

Cellular digital packet data (CDPD) is a North American wireless specification that is an enhancement to conventional analog services and operates on AMPS networks. It is based on the OSI model and uses the TCP/IP protocol to connect to the Internet and other public packet-switched networks. CDPD supports the ISO Connectionless Network Protocol (CLNP) as well as the IP protocol, including multicast service. Because it is an analog technology, a modem is required at the transmitting and receiving ends. CDPD has a raw data rate of 19,200 bps but an effective throughput rate of 9,600 bps.

Personal digital cellular

Personal digital cellular (PDC) is a TDMA-based, Japanese digital cellular standard that employs three time slots on a 23kHz carrier. It operates in the 800 MHz or 1.5 GHz frequency bands. PDC is a second-generation technology and is being replaced by third-generation technologies, such as W-CDMA.

Total Access Communication System

Total Access Communication System (TACS) is a first-generation Motorola analog FM technology, similar to AMPS, operating in the 900 MHz frequency range. It was used extensively in Europe and in Asia. An enhanced version of TACS with additional channels is called ETACS. TACS and ETACS have been replaced by GSM.

Nordic Mobile Telephone

Nordic Mobile Telephone (NMT) refers to the original Nordic Mobile Telephone system that came into service in 1981, covering large portions of Norway, Sweden, Denmark, and Finland. It was a first-generation analog system using FDMA.

International Mobile Telephone Standard 2000

The International Mobile Telephone Standard 2000 (IMT-2000) is the International Telecommunications Union (ITU, www.itu.int/home/imt.html) specification for a 3G mobile standard. It provides services for fixed, voice, mobile, data, multimedia, and Internet communications and supports seamless global roaming. IMT-2000 is designed for transmission rates of 2 Mbps for walking and stationary callers and 348 kbps for users in moving vehicles. It also provides for integration of satellite services with the cellular network. The IMT-2000 standard is designed to work with five radio interfaces and FDMA, TDMA, and CDMA technologies. Figure 12-8 shows these interfaces and technologies.

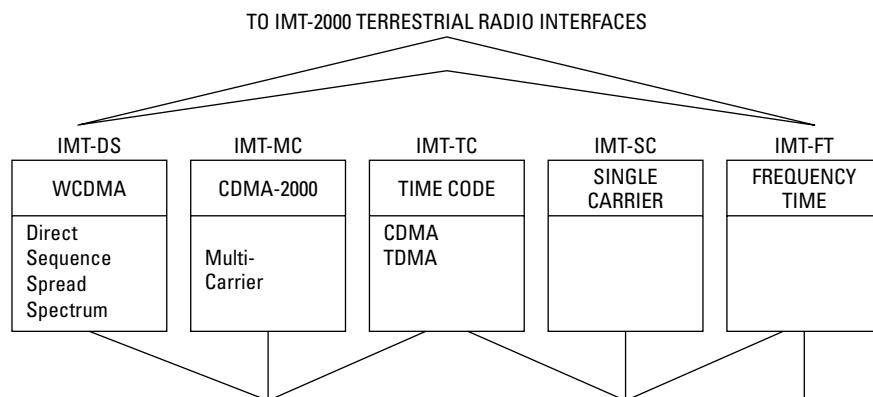

Figure 12-8: IMT-2000

Universal Mobile Telecommunications Systems

Universal Mobile Telecommunications Systems (UMTS) is a 3G mobile communications system that uses the IMT-2000 standard. It is being developed under the European Telecommunications Standards Institute (ETSI) and can provide data rates of up to 2 Mbps. UMTS operates in the 1885 to 2025 MHz and 2110 to 2200 MHz frequency bands, with the 1980 to 2100 MHz and 2170 to 2200 MHz designated for the satellite.

UMTS can operate in the following three modes defined by IMT-2000:

- ♦ **The Time Division Duplex (TDD) mode** — Uses TD-CDMA and supports asymmetrical and symmetrical data rates up to 2 Mbps in public micro and pico cell environments
- ♦ **The Frequency Division Duplex (FDD) mode** — Uses Wideband Code-Division Multiple-Access (W-CDMA) and supports data rates up to 384 kbps and 2 Mbps in public macro and micro cell environments
- ♦ **Multimode Terminal mode** — Employs GSM and UMTS FDD and TDD

W-CDMA is a 3G technology that is more complex than 2G systems in that it can accommodate multiple simultaneous users transmitting at different rates as a function of time.

The first commercial W-CDMA network was implemented in 2001 in Japan and, since then, other W-CDMA networks have been established in a number of European countries.

CDMA2000 is another 3G technology similar to W-CDMA. It is supported by Qualcomm and Lucent and can be deployed in the following phases:

1. **CDMA2000 1x** — Provides an average of 144 kbps packet data in a mobile environment
2. **CDMA2000 1x-EV-DO** — Provides data rates up to 2 Mbps on a dedicated data carrier
3. **CDMA2000 1x-EV-DV** — Provides higher peak rates than the other phases and also supports simultaneous voice and high-speed data

Table 12-1 provides a summary overview of the previously discussed wireless cellular systems.

Table 12-1
Wireless Cellular Systems Summary

System Acronym	System Name	Subscriber Receiver Bandwidth	Subscriber Transmitter Bandwidth	Multiple Access Method	Channel Spacing	Bit Rate
AMPS	Advanced Mobile Phone Service	869–894 MHz	824–849 MHz	FDMA	30 KHz	n/a
TACS	Total Access Communication System	916–949 MHz	871–904 MHz	FDMA	25 KHz	n/a
ETACS	Enhanced Total Access Communication System	916–949 MHz	871–904 MHz	FDMA	25 KHz	n/a
NTACS	Narrow-Band Total Access Communication System	860–870 MHz	915–925 MHz	FDMA	25 KHz	n/a
NMT-450	Nordic Mobile Telephone System	463–468 MHz	453–458 MHz	FDMA	25 KHz	n/a
NMT-900	Nordic Mobile Telephone System	935–960 MHz	890–915 MHz	FDMA	12.5 KHz	n/a

Continued

Table 12-1 (continued)

System Acronym	System Name	Subscriber Receiver Bandwidth	Subscriber Transmitter Bandwidth	Multiple Access Method	Channel Spacing	Bit Rate
IS-54/136	North American Digital Cellular	869–894 MHz	824–849 MHz	TDMA/FDM	30 KHz	48.6 kbps
GSM	Global System for Mobile Communication	935–960 MHz	890–915 MHz	TDMA/FDM	200 KHz	270.833 Kbps
PDC	Personal Digital Cellular (Japan)	810–826 MHz	940–956 MHz	TDMA/FDM	25 KHz	42 Kbps
PDC	Personal Digital Cellular (Japan)	1429–1453 MHz	1477–1501 MHz	TDMA/FDM	25 KHz	42 Kbps
CDPD	Cellular Digital Packet Data (WAN)	869–894 MHz	824–849 MHz	FDMA	30 KHz	19.2 Kb/s
UMTS (Europe)	High Tier PCS-1900 (based on GSM)	2110–2170 MHz	1900–1980 MHz	TDMA/FDM	200 KHz	64 Kbps – 2 Mbps
IMT-2000 (Japan)	High Tier PCS CDMA (based on IS-95)	2110–2160 MHz	1918–1980 MHz	CDMA/FDM	1250 KHz	1.2288 Mbps

A 2.5 G technology known as Enhanced Data rate for GSM Evolution (EDGE) builds on the General Packet Radio Service (GPRS) protocol. GPRS is an IP-based, packet-switched technology that supports burst transmission up to 1.15 Mbps. EDGE enables GSM operators to use existing GSM radio bands to offer wireless multimedia IP-based services. EDGE supports theoretical maximum speeds of 384 kbps with a bit-rate ranging from 48 kbps to 69.2 kbps per time slot, depending on conditions.

Pervasive Wireless Data Network Technologies

Two types of technologies are of critical importance in the implementation of wireless data networks: spread spectrum and orthogonal frequency division multiplexing (OFDM), a variation on spread spectrum. This section explores these technologies in detail.

Spread spectrum

Spread spectrum is an RF communications mechanism in which the baseband signal is spread over a wide frequency range through the injection of another high-frequency signal input. It falls under the general category of CDMA.

**Note**

Interestingly, spread spectrum technology was patented in 1941 by Hollywood actress Hedy Lamarr and her pianist, George Antheil. They were granted U.S. Patent # 2.292.387.

Spread spectrum wireless operates in the unlicensed industrial, scientific, and medical (ISM) band of frequencies, from 2400 MHz to 2483.5 MHz. It is used in the IEEE 802.11 wireless LAN standards as well as in cordless phones, wireless CCD cameras, and similar products.

Spread spectrum basics

The basis for understanding the operation of spread spectrum technology begins with the Shannon/Hartley channel capacity formula:

$$C = B \times \text{Log}_2(1+S/N)$$

In this formula, C is the channel capacity in bits per second, B is the required channel bandwidth (range of frequencies required) in Hz, and S/N is the signal-to-noise power ratio.

In other words, C is the amount of information allowed by the communication channel, the maximum data rate for a fixed bit error rate. The following example illustrates a typical calculation.

Assume that a communications channel has a 40 kHz bandwidth. What is the channel capacity for a signal-to-noise power ratio of 20 decibels, or 20 dB?

Before you can use the formula, you have to convert the signal-to-noise ratio in dB to a straight power ratio, recalling the formula for calculating dB from a power ratio is as follows:

$$\text{dB} = 10 \log_{10} (S/N)$$

Thus, you can state the power ratio of the problem as follows:

$$20 \text{ dB} = 10 \log_{10} (S/N)$$

For this equation to be true, $\log_{10} (S/N)$ must equal 2, so S/N must equal 100. Therefore, the straight power ratio to be used in the Shannon/Hartley equation is 100.

Substituting the problem values into the Shannon/Hartley equation yields the following:

$$C = 40 \times 10^3 \times \log_2 (1+100) = 40 \times 10^3 \times \log_2 (101)$$

or

$$C = 40 \times 10^3 \times 6.65821 = 266.328 \text{ kbps}$$

A profound result of the Shannon/Hartley equation is that the capacity of a communication channel for a given signal-to-noise ratio can be increased by increasing the channel bandwidth. This means that if there is a large amount of noise or jamming on a channel, the channel capacity can be increased by spreading the signal over a larger bandwidth. This condition is shown in the following analysis.

The Shannon/Hartley equation can be changed to incorporate the natural log, \log_e , which is represented by the symbol, \ln , by applying the following rule:

$$\log_2 A = \log_e A / \log_e 2 = \log_e A / 0.6930 \text{ and, therefore,}$$

$$\log_2 A = 1.443 \ln A$$

$$\text{Thus, } C = [B \times \ln (1+S/N)(1.443)] \text{ and}$$

$$C = 1.443B[\ln (1+S/N)]$$

Using the MacLaurin series expansion, that states

$$\ln(1+x) = x - x^2/2 + x^3/3 - x^4/4 + \dots \text{ yields}$$

$$C = 1.443B [S/N - 1/2(S/N)^2 + 1/3 (S/N)^3 - 1/4 (S/N)^4 + \dots]$$

Assuming the signal-to-noise ratio is low, meaning there is a lot of noise relative to the signal being transmitted, the equation can be approximated by the following:

$$C = 1.443B (S/N) \text{ or for a very rough approximation,}$$

$$C = B (S/N)$$

Thus, to maintain the maximum channel capacity for a very low signal-to-noise ratio, increase the bandwidth of the transmitted signal.

The two principal types of spread spectrum technology are *direct sequence spread spectrum* (DSSS) and *frequency hopping spread spectrum* (FHSS).

Direct sequence spread spectrum

DSSS uses a bit pattern called a *chip* or *chipping code* that is combined with the data to be transmitted and expands the bandwidth occupied by the transmission. On the receiving end, the same code is combined with the received information to extract the original data stream. This system offers increased immunity to noise or jamming signals in that any noise bursts superimposed on the RF signal being transmitted through the air are spread out and reduced in energy during decoding at the receiver. This process is summarized in Figure 12-9.

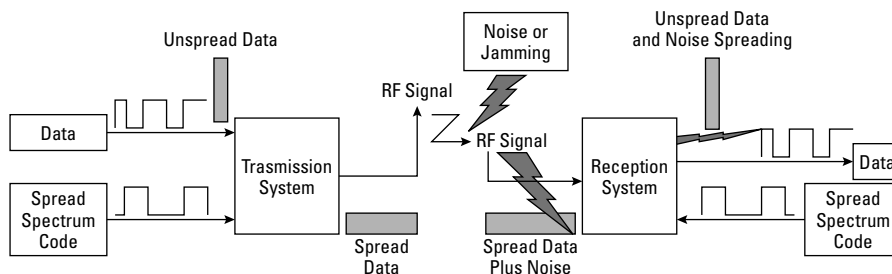

Figure 12-9: DSS transmission and reception in the presence of noise

The encoding and bandwidth spreading of the data at the transmitting end are accomplished by using the Exclusive Or function for the data bit stream with that of a higher frequency chip signal generated by a pseudorandom code generator. The Exclusive Or function's output is fed into the modulating portion of the transmitting system, combining with the local oscillator to generate the RF signal to be transmitted.

Frequency hopping spread spectrum

FHSS technology also spreads the transmitted signal over a wideband, but accomplishes this by hopping the carrier frequency among different frequencies. The transmitter and receiver must be synchronized so that they are on the same frequency at the same time.

The hopping rate determines whether the particular instantiation of FHSS is low frequency hopping spread spectrum (LFHSS) or fast frequency hopping spread spectrum (FFHSS). In LFHSS, multiple consecutive data bits modulate the carrier frequency, where, in FFHSS, there are multiple frequency hops per data bit. If there are n frequency slots used in FHSS, the total bandwidth of the frequency-hopping signal equals Bn , where B is the bandwidth of each frequency hop channel. Figure 12-10 illustrates the frequency hop signal.

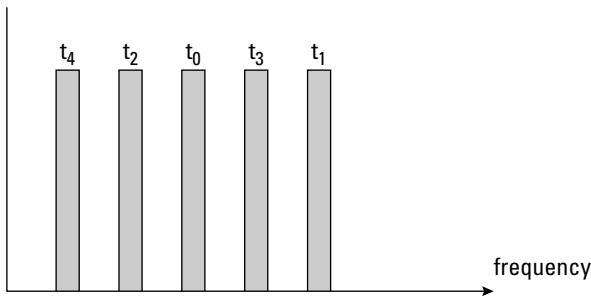

Figure 12-10: Frequency hopping example

The FCC requires that FHSS use a minimum of 75 frequencies with a maximum dwell time on one frequency of 400 ms. With the randomness of frequency hopping, multiple FHSS systems can exist in close proximity without interfering with each other's transmissions.

Orthogonal Frequency Division Multiplexing

Orthogonal Frequency Division Multiplexing (OFDM) is a spread spectrum variation of FDM. It divides the signal to be transmitted into smaller subsignals and then transmits them simultaneously at different carrier frequencies. These carrier frequencies are spaced at specific frequencies. This technique makes OFDM resistant to cross talk and interference from multipath transmissions (that is, the same transmission arriving at the receiver at different times because of different length paths taken).

The basic concepts behind OFDM are as follows:

- ♦ By using a rectangular carrier pulse, modulation is accomplished by performing an Inverse Fast Fourier Transform (IFFT).
- ♦ By Fourier analysis, the rectangular pulse shape yields subcarriers defined by the function $\sin(x)/x$, as shown in Figure 12-11.

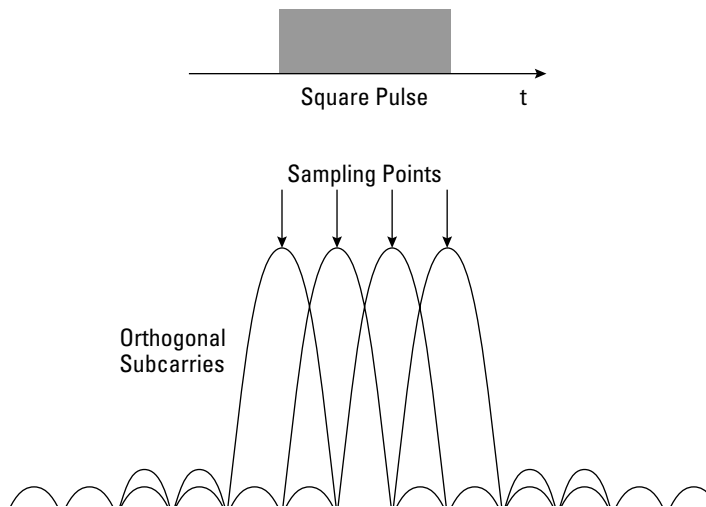

Figure 12-11: OFDM subcarriers

The orthogonality in OFDM comes from the subcarrier spacings, as shown in Figure 12-11. The IFFT modulation of the square pulse produces subcarrier spacings, at which, when sampled at the points shown in Figure 12-11, all other signals are at zero value. Thus, the subcarrier is orthogonal to all the other signals. At the receiving end, a Fast Fourier Transform is applied to recover the original data. OFDM is used in the IEEE 802.11 Wireless LAN standard, Asymmetric DSL, and for digital television in Australia, Europe, and Japan.

IEEE Wireless LAN Specifications

The IEEE 802.11 family of wireless LAN standards specifies an interface between a wireless client and a base station or access point, as well as among wireless clients. Work on the first standard, 802.11, began in 1990 and evolved from various draft versions; approval of the final of 802.11 draft occurred on June 26, 1997.

The 802.11 specification identifies an over-the-air interface between a mobile device wireless client and a base station or between two mobile device wireless clients.

The IEEE 802.11 standard specifies parameters of both the physical (PHY) and medium access control (MAC) layers of the network.

The PHY layer

The PHY layer is responsible for the transmission of data among nodes. It can use DSSS, FHSS, OFDM, or infrared (IR) pulse position modulation. The family of standards supports data rates ranging from 2 Mbps to 54 Mbps, with the early draft of a proposed new standard, 802.11n, targeting 100 Mbps.

The MAC layer

The MAC layer is a set of protocols responsible for maintaining order in the use of a shared medium. The 802.11 standard specifies a carrier sense multiple access with collision avoidance (CSMA/CA) protocol for the wireless LANs. The MAC layer provides the following services:

- ♦ **Data transfer** — CSMA/CA media access.
- ♦ **Association** — Establishment of wireless links between wireless clients and access points in infrastructure networks.
- ♦ **Reassociation** — An action that occurs in addition to association when a wireless client moves from one Basic Service Set (BSS) network to another, such as in roaming. A BSS is a group of 802.11-compliant stations that comprise a fully connected wireless network.
- ♦ **Authentication** — The process of proving a client identity through the use of an 802.11 authentication mechanism.
- ♦ **Privacy** — In the 802.11 family of standards, there are options for different levels of protection of the transmitted data. These options are discussed in detail in a later section of this chapter.

802.11 offers two operational modes: ad hoc and infrastructure.

The *ad hoc mode* refers to Independent Basic Service Set (IBSS) networks, which do not have a backbone infrastructure and involve at least two wireless stations. IBSS is not intended for long-range use, but is normally implemented in rooms or sections of a building. Ad hoc mode is a peer-to-peer networking paradigm in which each mobile client communicates directly with other mobile clients in the network and only clients within the same cell can communicate. Communication outside of the cell can take place if a cell member operates as a routing service.

The *infrastructure mode* refers to BSS networks that incorporate access points to communicate between mobile devices and the wired network or other wireless networks.

As of this writing, there are five 802.11 standards: 802.11, 802.11a, 802.11b, 802.11g, and 802.11e. 802.11e differs from the others in that it focuses on providing for quality of service (QoS) in a wireless LAN. A proposed standard that is in development at this time is standard 802.11n. Table 12-2 summarizes the characteristics of the 802.11 family.

Table 12-2
IEEE 802.11 Wireless LAN Standards

<i>Standard</i>	<i>Band</i>	<i>Technology</i>	<i>Transmission Speed</i>	<i>Comments</i>
802.11	2.4 GHz	FHSS or DHSS	1 or 2 Mbps	Original wireless LAN standard
802.11b	2.4 GHz	DSS	11 Mbps, but decreases to 5.5 Mbps, 2 Mbps, or 1 Mbps as a function of signal strength	Extension to 802.11; known as Wi-Fi
802.11a	5 GHz	OFDM	54 Mbps	Extension to 802.11
802.11g	2.4 GHz	OFDM	54 Mbps	Extension to 802.11
802.11e Quality of Service (QoS) Standard				Guaranteed timely delivery of application data to specified destinations; provides guaranteed bandwidth; supports streaming multimedia files; incorporates error correction.
802.11n proposed standard	5 GHz	OFDM proposed	Targeting 100 Mbps	Currently under development; probability of using Multiple-In, Multiple-Out (MIMO) scheme. MIMO uses multiple transmitting antennas, tuned to the same channel, with each antenna transmitting a different signal. The receiver has the same number of antennas that listen to all transmitters. The received signals are recombined to recover the transmitted data.

IEEE 802.11 Wireless Security

The original 802.11 wireless LAN specifications defined a security option, Wired Equivalent Privacy (WEP). In WEP, a shared key is configured into the access point and its wireless clients. In the 802.11 standard, data is transferred in the clear by default. If confidentiality is desired, the WEP option encrypts data before it is sent. The WEP algorithm is the RC4 symmetric cipher. The algorithm employs a secret key that is shared between a mobile station (for example, a laptop with a wireless Ethernet card) and a base station access point to protect the confidentiality of information being transmitted on the LAN. The transmitted packets are encrypted with a secret key and an Integrity Check (IC) field composed of a CRC-32 check sum attached to the message.

The WEP implementation is weak in both confidentiality and authentication, and, with tools readily available on the Internet, WEP is easily broken and messages compromised. As a result, stronger privacy systems have been implemented for 802.11. The evolution of these mechanisms is detailed in the following sections.

WEP

As previously noted, WEP uses the RC4 symmetric key stream cipher for protecting the confidentiality of the transmitted messages. WEP also provides for a weak authentication of the user station to the access point, but not vice versa. This authentication is usually accomplished using a shared secret key to encrypt the data frames. The WEP symmetric key is comprised of two components, a variable, 24-bit Initialization Vector (IV) and a fixed 40- or 104-bit secret key. Because the secret key is seldom changed, the purpose of the IV is to thwart cryptanalysis against WEP by having the client use a different IV when encrypting message packets.

Because of the limited processing power in commodity-produced access points, the RC4 stream encryption algorithm is off-loaded to custom hardware. The hardware functions encrypt each message packet with a key that is comprised of the concatenation of a base secret key with an IV. The packet construction and the key composition are illustrated in Figure 12-12.

Note that the IV is transmitted as plaintext in the packet. When the packet is received at the access point, the hardware function retrieves the base secret key that it knows, concatenates it with the IV in the transmitted message packet, and uses this key to decrypt the packet.

However, because the IV is relatively short, packet monitoring will show repetitions of the IV and, thus, enable attackers to obtain the base secret key. One approach is to use the plaintext IV and discover WEP RC4 weak keys to mount a known plaintext attack. Researchers at UC Berkeley (www.isaac.cs.berkeley.edu/isaac/wep-faq.html) have shown that WEP security can be easily broken. Subsequently, a freely available program called AirSnort was widely distributed on the Internet that can be used to break WEP encryption and read transmitted messages. WEP is also vulnerable to forgery and replay attacks, wherein an attacker can modify packets and retransmit them or capture packets and retransmit them at a later time.

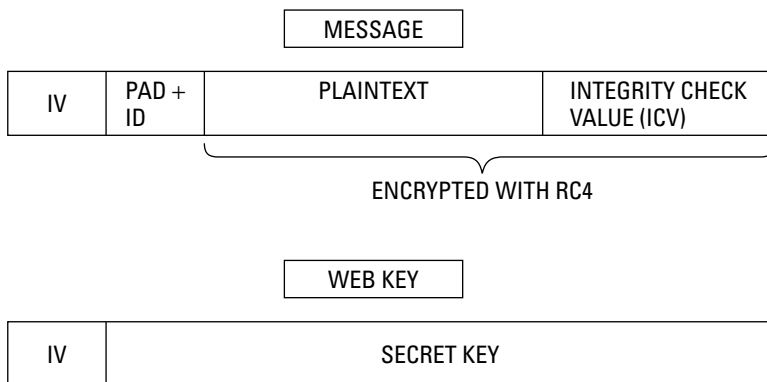

Figure 12-12: A WEP message and key

WEP provides for open and shared key authentication. The following sections describe each option and their associated vulnerabilities.

WEP open authentication

In *WEP open authentication* a client station provides a *Service Set Identity (SSID)* that is common to the stations on its network segment and its access point. This SSID authorizes and associates a client station to the access point. A vulnerability exists with this approach in that the access point transmits the SSID in the clear at intervals in management frames. Thus, the SSID is easily available to attackers to establish an association with the access point.

WEP shared key authentication

The *WEP shared key architecture* was intended to implement secure authentication of the client by the access point through the following steps:

1. The client station transmits an authorization request.
2. The access point returns a challenge string in the clear.
3. The client chooses an IV.
4. Using the IV and secret base key, the client encrypts the challenge string.
5. The client station sends the IV and encrypted challenge string to the access point.
6. The access point also encrypts the challenge string using the transmitted IV and the same secret base key.
7. If the client's encrypted challenge string is identical to the challenge string sent by the client station, the association occurs.

The vulnerability in this process is that cryptanalysis can use the intercepted plain text/cipher text pair and IV to determine the RC4 key. This attack is possible when

all the IVs have been exhausted for a session and the IVs have to be reused. In this situation, when IV1 in a message is equal to IV2 in another message, the cryptanalysis proceeds as follows:

1. Ciphertext C1 = Plaintext P1 XOR [Stream Cipher RC4 with key generated through the use of K, IV1]
2. Ciphertext C2 = Plaintext P2 XOR [Stream Cipher RC4 with key generated through the use of K, IV2]
3. If IV1 = IV2, then proceed to Step 4.
4. $C1 \text{ XOR } C2 = \{ \text{Plaintext P1 XOR [Stream Cipher RC4 with key generated through the use of K, IV1]} \} \text{ XOR } \{ \text{Plaintext P2 XOR [Stream Cipher RC4 with key generated through the use of K, IV2]} \} = P1 \text{ XOR } P2$, the XOR of the two plaintexts.

With the Exclusive Or of the two plain text items known corresponding to the transmitted cipher text items, dictionary attacks can be applied to determine the plain text items.

WEP security upgrades

Because of the weaknesses in WEP security, IEEE 802.11 established Task Group i (TGi) to develop approaches to address WEP problems. TGi had to consider a number of issues and constraints. One path was to redesign 802.11 security so as not to include any legacy WEP functions. Another path was to upgrade WEP security while keeping the same WEP architecture. Both approaches were chosen, resulting in the completely new 802.11i standard and the upgraded WEP encryption and integrity method called the *Temporal Key Integrity Protocol* (TKIP). The latter approach was necessary to accommodate the huge base of existing wireless WEP devices already deployed and to have improved security in place because of the anticipated delay in developing and finalizing the 802.11i standard. The installed WEP implementations have hardware-based WEP functions that cannot be easily modified, so the TKIP solution was chosen because it can be installed as a software upgrade to the legacy systems. In addition, because of the limited additional computing capability remaining on extant access points, the TKIP upgrade could not be computing resource intensive. TKIP uses the *802.1X authentication architecture* as a basis for secure key exchange, so the next section briefly describes 802.1X as a precursor to an overview of the TKIP algorithms.

802.1X authentication

802.1X is a port-based authentication mechanism that operates under the *Extensible Authentication Protocol* (EAP) transport protocol (RFC 2284). For wireless LANs, the EAP protocol is known as EAP over LAN (EAPOL). EAPOL is applied to the exchange

of challenges and responses between client stations, or *supplicants*, as they are called in the protocol, and an authentication server. The third entity in 802.1X is the *authenticator*, a dual access control port, similar to the access point. The authentication server is usually a RADIUS server, but other authentication servers can be employed. In this discussion, a RADIUS server is used. EAPOL supports a number of protocols, including Transport Layer Security (TLS), RFC 2246. A typical authentication process employing EAPOL proceeds as follows:

1. The supplicant sends credentials to the RADIUS server.
2. The RADIUS server provides credentials to the supplicant.
3. Upon mutual authentication, the protocol is used to establish session keys.
4. The session keys are used to encrypt the client station message.

In detail, the sequence occurs in the following steps:

1. A conventional 802.11 association is established.
2. At this point, all non-802.1X traffic is blocked.
3. The RADIUS server sends a challenge to the supplicant (client station).
4. The client hashes the user-provided password as a response to the RADIUS server. This hash is sent to the RADIUS authentication server through the authenticator.
5. The RADIUS server uses the same process to compute the hash based on its database of user passwords.
6. If a match of the hashes is obtained, the RADIUS server generates a dynamic WEP secret key and sends it to the authenticator.
7. The WEP secret key is sent to the client via EAPOL key frames.
8. The secret keys are updated at specified intervals.

Because employing 802.1X for WEP encryption does not eliminate weak IV and IV collision vulnerabilities, TKIP was developed to address these and other WEP security weaknesses.

Temporal Key Integrity Protocol

TKIP is built around the existing WEP security algorithm because of the necessity of not adding complex cryptographic algorithms whose execution would far exceed the spare CPU cycles available on most of today's deployed access points. Table 12-3 lists the upgrades provided by TKIP in terms of the security weaknesses addressed.

Table 12-3
TKIP Upgrades for WEP Weaknesses

<i>Weakness</i>	<i>TKIP Upgrade</i>
Correlation of IVs with weak keys	Per-packet key mixing function
Replay	IV sequencing discipline
Key reuse	Rekeying approach
Susceptibility to forgery	Message Integrity code (MIC) called Michael

Per-packet mixing function

The TKIP *per-packet key mixing function* addresses the problem of correlating IVs with weak keys by using a key that varies with time, or temporal key, as the WEP secret base key. It then uses the packet sequence counter and temporal key to construct the per-packet key and IV. These operations hide the relationship between the IV and the per-packet key and are illustrated in Figure 12-13.

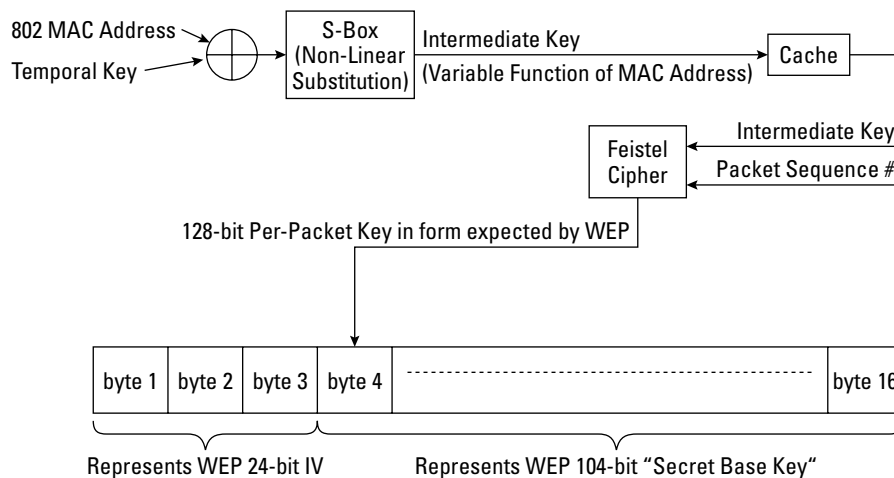

Figure 12-13: TKIP per-packet mixing function

The process in Figure 12-13 shows that using the Exclusive Or function for the local MAC address with the temporal key results in different client stations and access points generating correspondingly different intermediate keys. Thus, the per-packet encryption keys are different at every client station. The result of the total process is a 16-byte packet that corresponds to the input that is expected by existing WEP hardware.

IV sequencing discipline

As a control against replay attacks, TKIP applies an IV sequencing discipline in which a receiver determines if a packet is out of sequence. If that condition is true, the receiver assumes it is a replay and discards the packet. A packet is defined as out of sequence if its IV is less than or equal to that of a previously correctly received packet. By using the WEP IV field as a packet sequence number, the procedure for detecting and countering replays is summarized as follows:

1. New TKIP keys are used.
2. Receiver and transmitter initialize the packet sequence number to zero.
3. As each packet is transmitted, the packet sequence number is incremented by the transmitter.
4. The IV sequencing discipline is applied to determine if a packet is out of sequence and a replay has occurred.

This procedure is illustrated in Figure 12-14.

Message Integrity Codes against forgery

An ideal *Message Integrity Code* (MIC) is a unique, unambiguous representation of the transmitted message that will change if the message bits change. Thus, if an MIC is calculated using an authentication key by a transmitting entity and sent with the message, the receiver can similarly calculate another MIC based on the message and compare it to the MIC that accompanied the message. If the two MICs are identical, in theory, the message was not modified during transmission.

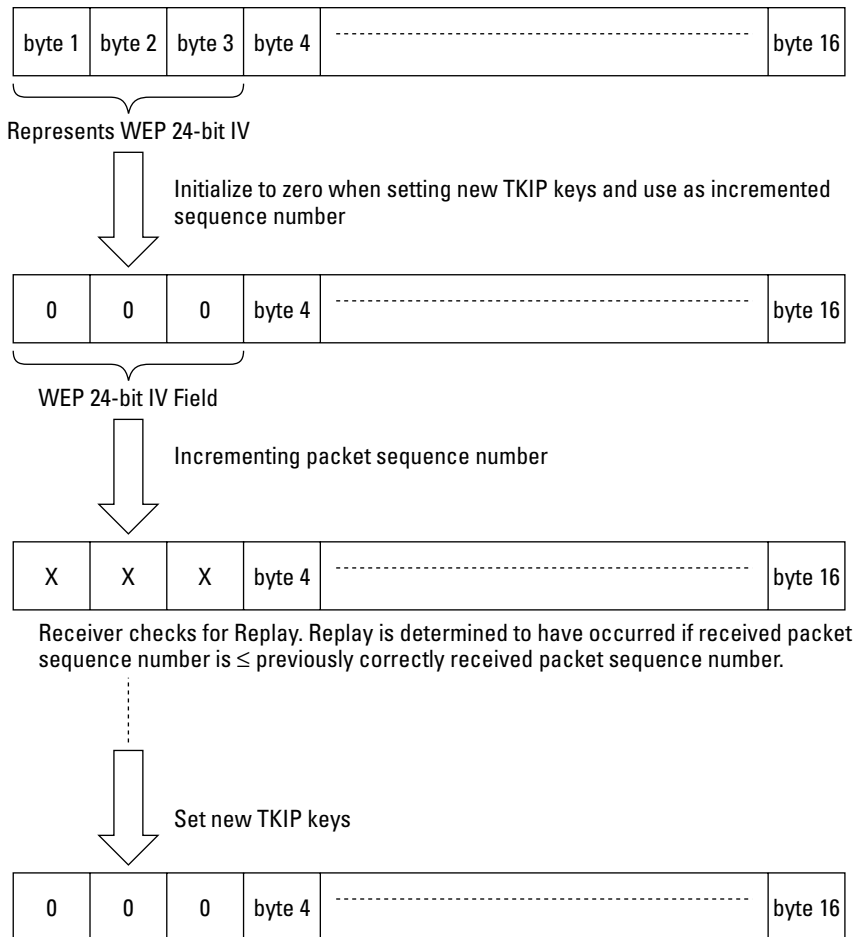

Figure 12-14: TKIP replay sequence checking

In TKIP, the 64-bit MIC is called *Michael* and was developed by Niels Ferguson, an independent cryptography consultant based in Amsterdam, Holland. His Web site is located at www.macfergus.com/niels/. The TKIP MIC process is illustrated in Figure 12-15.

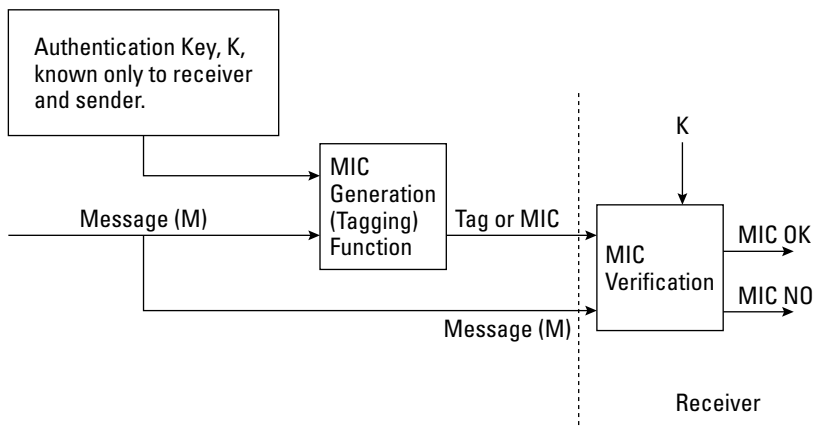

Figure 12-15: TKIP MIC generation and verification

Rekeying against key reuse

To protect against key reuse, 802.1X uses a hierarchy of master keys, key encryption keys, and temporal keys. The 802.1X temporal keys are used in the TKIP authentication and confidentiality processes. A temporal key set comprises a 64-bit key for the MIC process, as described in the previous section, and a 128-bit encryption key. A different set of temporal keys is used in each direction when an association is established. The material used to generate the temporal keys must be protected from compromise and this protection is accomplished by use of key encryption keys. The master key is needed to set up the key encryption keys. This process is summarized as follows:

- ♦ 802.1X defines that the authentication server and client station share a secret key, the master key.
- ♦ 802.1X defines that the authentication server and access point share a secret key, derived by the authentication server and client station from the master key and distributed by the authentication server to the access point.
- ♦ A new master key is used with each session (a session covers the time from authentication to when the key expires, is revoked, or when a client station no longer communicates).
- ♦ The master key is used to protect the communication of key encryption keys between a client station and the access point.
- ♦ The key encryption keys are employed to protect the transmitted keying material used by the access point and client to generate sets of temporal keys.
- ♦ The pairs of temporal keys are used for integrity protection and confidentiality of the data.

Figure 12-16 shows the relationships and locations of the three types of keys.

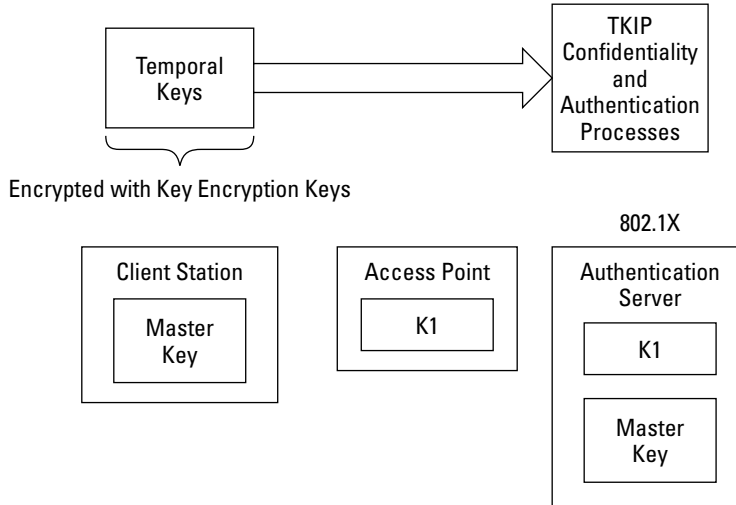

Figure 12-16: Key hierarchy for rekeying

802.11i

The 802.11i wireless security standard was ratified in June of 2004. The IEEE 802.11 committee considers this specification a long-term solution to wireless security. It incorporates TKIP, 802.1X, and the Advanced Encryption Standard (AES). AES is a block cipher and, in 802.11i, processes plain text in 128-bit blocks. It uses the following set of keys:

- ♦ **A symmetric master key** — Possessed by the authentication server and client station for the positive access decision
- ♦ **A pairwise master key (PMK)** — A fresh symmetric key possessed by the access point and client station and used for authorization to access the 802.11 medium
- ♦ **A pairwise transient key (PTK)** — A collection of the following operational keys:
 - **Key encryption key (KEK)** — Used to distribute the group transient key (GTK), which is an operational temporal key used to protect multicast and broadcast data

- **Key confirmation key (KCK)**—Binds the PMK to the client station and access point
- **Temporal key (TK)**—Protects transmitted data

Thus, 802.11i employs a 128-bit key, combines encryption and authentication, uses temporal keys for both functions, and protects the entire 802.11i packet. Relative to the authentication server and EAP, RADIUS and EAP-TLS are not officially a part of 802.11i, but are de facto standards for use in 802.11i.

The next sections explore the AES and its employment in 802.11i because it is the major component of and provides the increased security capabilities in the new standard.

AES Counter and Cipher-Block Chaining modes

The two modes of operation of AES relative to 802.11i are Counter (CTR) mode and Cipher-Block Chaining (CBC) mode.

In the CTR mode of operation, AES employs a monotonically increasing counter. The encryption process in the CTR mode is summarized as follows and is shown in Figure 12-17:

1. The Message, M , is broken into 128-bit blocks M_1, M_2, \dots, M_n
2. The key is determined.
3. The counter is initialized to zero.
4. For each block processed, increment the counter by one.
5. For each block, the counter value is encrypted.
6. The encrypted counter value is XORed with the plain text block, M_i , to generate the cipher text block, C_i .
7. When all the plain text blocks have been encrypted, the initial counter value is prepended to the cipher text blocks to generate the message (counter₀) $C = (\text{counter}_0)\{C_1, C_2, \dots, C_n\}$.
8. The message is transmitted.
9. The receiver decrypts the message by reversing the process. It uses the prepended initial counter value as a starting point.

For security, the CTR mode requires a new, different key for every session.

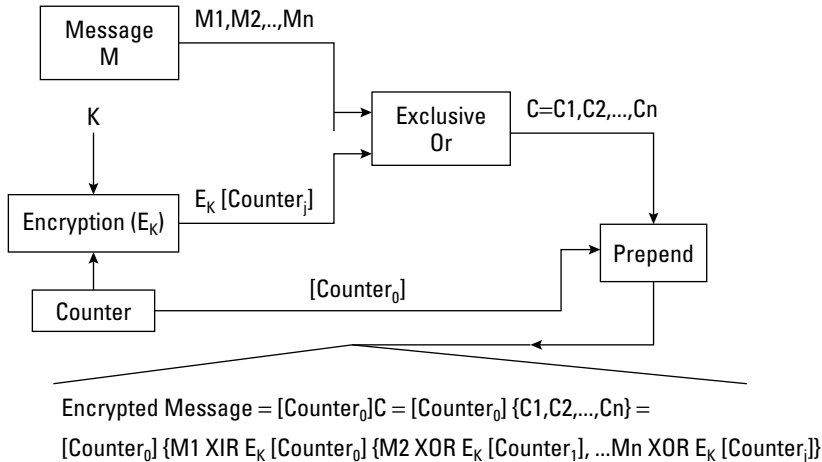

Figure 12-17: AES CTR mode

The AES CBC mode employs an initialization vector for enhanced security and operates in the following steps:

1. The Message, M, is broken into 128-bit blocks $M1, M2, \dots, Mn$.
2. A random initial IV value is chosen.
3. This first IV value is XORed with plain text block, $M1$.
4. Encrypted block, $C1$, is generated by encrypting the result of the XOR in the previous step with the encryption key, K . $C1$ also becomes the next IV to be used in the XOR function with $M2$.
5. This process iterates until all plain text blocks are encrypted.
6. The message to be transmitted is assembled by prepending the initial IV to the cipher text $C = C1, C2, \dots, Cn$.
7. The receiver performs decryption by using the prepended initial IV value and reversing the process.

A different, initial IV must be used for each new message to maintain security.

The steps in the CBC mode are shown in Figure 12-18.

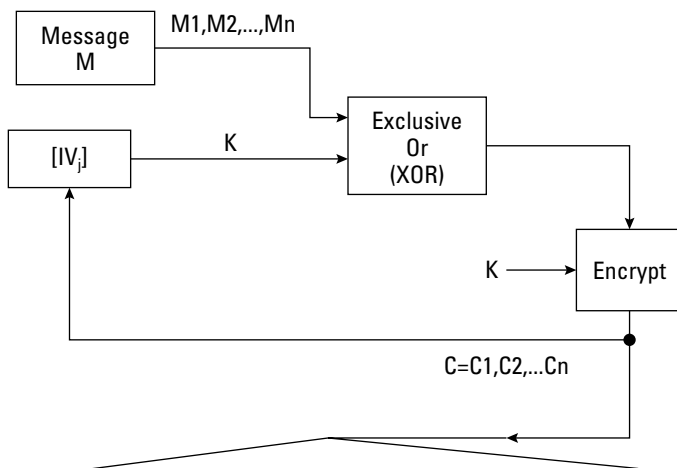

$$\text{Encrypted Message} = [IV_0]C = [IV_0] \{C_1, C_2, \dots, C_n\} = [IV_0] \{E_K [M_1 \text{ XOR } IV_0], E_K [M_2 \text{ XOR } [IV_1]], \dots, E_K [M_n \text{ XOR } [IV_j]]\}$$

Figure 12-18: AES CBC mode

The AES CBC mode can also be employed to generate an MIC and ensure that a message has not been modified during transmission. The MIC is generated as follows:

1. The Message, M , is broken into 128-bit blocks M_1, M_2, \dots, M_n .
2. An initial IV value that is known to the transmitter and receiver is chosen.
3. This first IV value is XORed with plain text block, M_1 .
4. A Tag block, MIC_1 , is generated by encrypting the result of the XOR in the previous step with the encryption key, K . MIC_1 also becomes the next IV to be used in the XOR function with M_2 .
5. This process iterates until the last Tag block, MIC_n , is generated.
6. The Tag block, MIC_n , is appended to the transmitted message as an integrity check.

The receiver generates an MIC_n using the same algorithm and initial IV as the transmitter and compares it to the MIC_n received with the message. If the values match, the message is assumed to have been transmitted without modification.

Figure 12-19 illustrates AES MIC generation.

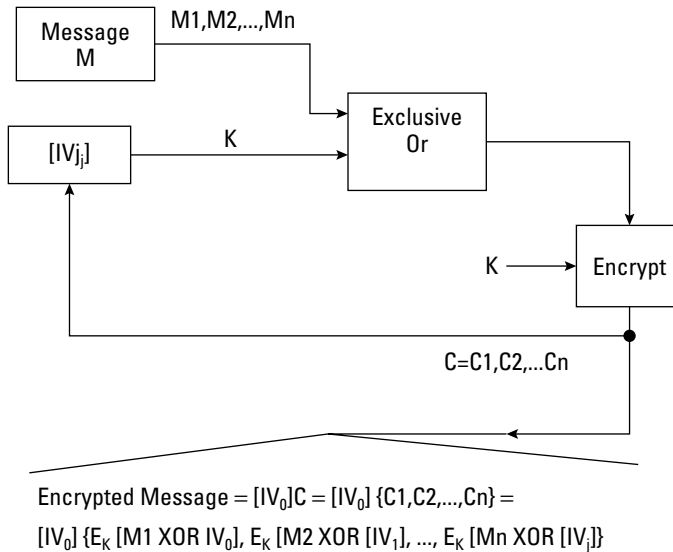

Figure 12-19: CBC mode for MIC generation

Application of AES in 802.11i

The AES is applied in 802.11i in the form of the AES—Counter with CBC-MAC (AES-CCM) protocol. AES-CCM applies the AES CTR mode for confidentiality of data and combination CBC-MAC mode for data integrity.

AES-CCM uses the same AES key for encryption and for generating an MIC. In addition, AES-CCM employs a 48-bit packet sequence counter. This counter is then applied in the CTR mode and in the generation of the CBC-MAC mode initialization vector. The following steps describe this process:

1. Concatenate the source MAC address, the packet sequence counter, a 16-bit per-packet block counter, and a 16-bit string to form the CTR mode counter and CBC MAC-IV. The 16-bit string differentiates the two concatenation results as being the CTR mode counter or the CBC-MAC IV.
2. Increment the packet sequence counter.
3. The CCM-MAC IV and secret AES key are used to compute an MIC over the message packet, including the source and destination addresses.
4. Truncate the MIC to 64 bits.
5. Encrypt the packet and append MIC, applying the CTR mode counter and secret AES key.

6. Insert the packet sequence counter number in between the 802.11 header field and the encrypted message data.
7. Transmit the packet.

On the receiving end, the packet sequence counter is obtained from the message packet and checked for replay. If the message is valid, the packet sequence counter is used to generate the CTR mode counter and the CBC-MAC IV. Then, the process steps used in the transmission process are reversed.

The AES-CCM mode protects against forgeries through the use of an MIC, protects against replays by checking the packet sequence counter, encrypts the source and destination addresses, and does not use an initialization vector or counter value with the same AES secret key.

Additional 802.11i capabilities

802.11i provides for pre-authentication for roaming and, also, a Pre-Shared Key (PSK) mode. In this mode, there is no authentication exchange and a single private key can be assigned to the entire network or on a per-client station pair. PSK is amenable for use in ad hoc and home networks. The PSK mode uses the PKCS#5v2.0PBKDF2 key derivation function to produce a 256-bit PSK from an ASCII string password. RFC 2898, PKCS #5: Password-Based Cryptography Specification Version 2.0” describes this operation, which applies a pseudorandom function to derive keys. The PSK mode is vulnerable to password/passphrase guessing using dictionary attacks.

Bluetooth

Bluetooth is a peer-to-peer, short-range protocol named after Haral Bluetooth, the king of Denmark in the late 900s. It is used to connect cellular phones, laptops, handheld computers, digital cameras, printers, and so on. It is defined in IEEE standard, IEEE 802.15 and has the following characteristics:

- ♦ **FHSS**—Hops 1,600 times per second among 79 RF channels
- ♦ **Transmission rate**—1 Mbps
- ♦ **Transmission distance**—About 30 feet
- ♦ **Frequency band**—2.4 Ghz to 2.5Ghz
- ♦ **Transmitting power**—1 milliwatt, which minimizes interference with other networks (cell phones can transmit up to 3 watts of power)
- ♦ **Transmission range extension**—Range can be extended to 300 feet by increasing transmitting power to 100 milliwatts
- ♦ **Number of devices on the network**—8

Because FHSS is used, other Bluetooth networks can exist in the same area without any mutual interference. Bluetooth devices operate by setting up a personal area network (PAN) called a *piconet* based on the devices' assigned addresses. A Bluetooth piconet operates in the following manner:

- ♦ As an ad hoc network.
- ♦ All Bluetooth devices are peer units.
- ♦ Different piconets have different frequency hopping sequences to prevent interference.
- ♦ All devices on the same piconet are synchronized to the frequency hopping sequence for that piconet.
- ♦ One device operates as a master and the other devices operate as slaves (point-to-multipoint topology).
- ♦ A maximum of 7 active slaves can exist on a piconet, each assigned a 3-bit active member address.
- ♦ Up to 256 inactive (*parked*) slaves that are synchronized to the frequency-hopping sequence can be assigned to the piconet. They can activate rapidly because they are synchronized.

Bluetooth security uses challenge response protocols for authentication, a stream cipher for encryption, and dynamic session keys.

Wireless Application Protocol

The Wireless Application Protocol (WAP) is widely used by mobile devices to access the Internet. Because it is aimed at small displays and systems with limited bandwidth, it is not designed to display large volumes of data. In addition to cellular phones and PDAs, WAP is applied to network browsing through TV and in automotive displays. It has analogies to TCP/IP, IP, and HTML in wired Internet connections and is actually a set of protocols that covers Layer 7 to Layer 3 of the OSI model. Due to the memory and processor limitations on mobile devices, WAP requires less overhead than TCP/IP.

WAP has evolved through a number of versions, the latest being version 2.0. WAP 2.0 includes support for the transmission and reception of sound and moving pictures over telephones and other devices, as well as providing a toolkit for development and deployment of new services, such as Extensible Hypertext Markup Language (XHTML).

The WAP architecture comprises the following levels:

- ♦ **Application layer**— Contains the wireless application environment (WAE) and is the direct interface to the user. The Application layer includes the following:
 - The Wireless Markup Language (WML)
 - A microbrowser specification for Internet access
 - WMLScript (development language)

The Handheld Device Markup Language (HDML) is a simpler alternative to and actually preceded WML. HDML contains minimal security features, however. Another alternative is Compact HTML (C-HTML). Used primarily in Japan through NTT DoCoMo's i-mode service, C-HTML is essentially a stripped-down version of HTML. Due to this approach, C-HTML can be displayed on a standard Internet browser.

- ♦ **Session layer**— Contains the Wireless Session Protocol (WSP), which facilitates the transfer of content between WAP clients and WAP. This layer provides an interface to the WAE through the following activities:
 - Connection creation and release between the client and server
 - Data exchange between the client and server
 - Session suspend and release between the client and server
- ♦ **Transaction layer**— Provides functionality similar to TCP/IP through the Wireless Transactional Protocol (WTP). WTP provides transaction services to WAP, including acknowledgment of transmissions, retransmissions, and removal of duplicate transactions.
- ♦ **Security layer**— Contains Wireless Transport Layer Security (WTLS). WTLS is based on Transport Layer Security (TLS) and can be invoked similar to HTTPS in conventional Web browsers. WTLS supports privacy, data integrity, DoS protection services, and authentication. WTLS provides the following three types of authentication:
 - **Class 1 (anonymous authentication)**— The client logs on to the server, but in this mode, neither the client nor the server can be certain of the identity of the other.
 - **Class 2 (server authentication)**— The server is authenticated to the client, but the client is not authenticated to the server.
 - **Class 3 (two-way client and server authentication)**— The server is authenticated to the client and the client is authenticated to the server.

Authentication and authorization can be performed on the mobile device using smart cards to execute PKI-enabled transactions. A specific security issue that is associated with WAP is the WAP GAP. A WAP GAP results from the requirement to change security protocols at the carrier's WAP gateway from

the wireless WTLS to Secure Sockets Layer (SSL) for use over the wired network. At the WAP gateway, the transmission, which is protected by WTLS, is decrypted and then re-encrypted for transmission using SSL. Thus, the data is temporarily in the clear on the gateway and can be compromised if the gateway is not adequately protected. To address this issue, the WAP Forum has put forth specifications that will reduce this vulnerability and support e-commerce applications. These specifications include WMLScript Crypto Library and the WAP Identity Module (WIM). The WMLScript Crypto Library supports end-to-end security by providing for cryptographic functions to be initiated on the WAP client from the Internet content server. These functions include digital signatures originating with the WAP client and the encryption and decryption of data. The WIM is a tamper-resistant device, such as a smart card, that cooperates with WTLS and provides cryptographic operations during the handshake phase. A third alternative is to use a client proxy server that communicates authentication and authorization information to the wireless network server.

- ♦ **Transport layer**— Supports the Wireless Datagram Protocol (WDP), which provides an interface to the wireless networks. It supports network protocols such as GSM, CDMA, and TDMA. It also performs error correction.

The Public Key Infrastructure (PKI) for mobile applications provides for the encryption of communications and mutual authentication of the user and application provider. One concern associated with the mobile PKI relates to the possible time lapse between the expiration of a public key certificate and the reissuing of a new valid certificate and associated public key. This “dead time” may be critical in disasters or in time-sensitive situations. One solution to this problem is to generate one-time keys for use in each transaction.

Summary

This chapter reviews the electromagnetic spectrum and focuses on the UHF band for cellular phone communications. The major components of the cellular phone network are described, including the mobile station, cell tower, subscriber identity module, base transceiver station, and mobile switching center. TDMA, FDMA, and CDMA technologies are explained along with a subset of CDMA, spread spectrum technology. In particular, DSS, FSS, and OFDM spread spectrum implementations are discussed. The different generations of cellular systems development, including AMPS, TACS, NMT, GSM, UMTS, and IMT-2000 are reviewed. The 802.11 wireless LAN standard, including its various upgrades and instantiations are explained and summarized, including 802.11, 802.11a, 802.11b, 802.11g, and 802.11i. The related 802.11 wireless security issues are explored and the various solutions to the original 802.11 WEP security deficiencies are developed. In conclusion, Bluetooth piconets are introduced and the WAP protocols are detailed.



Network Architecture Fundamentals

Network communication has been a very significant development over the past 25 years. In particular, the 1990s saw a huge expansion of public access and public-oriented communication networks that had the ability to bind the entire world into a single network. Current networking technology has its roots in military and academic research projects initiated in the 1970s. Thus, networks are no longer a prerogative for the exclusive, but an essential tool and object in the routine life of everybody. The architecture of public networks and, more important, the Internet is very complex and sophisticated. Some of the vital applications and components incorporated into present day networks include the following:

- ◆ Web browsing
- ◆ File transfers
- ◆ E-mail
- ◆ Remote logins
- ◆ Multimedia
- ◆ Telephony
- ◆ Security services

Organizations such as the IETF, IEEE, and so on continually endeavor to enhance these vital components of public networks. This chapter focuses on some of the basic network components used in the present Internet and other network technology (most important, network security services).

CHAPTER 13



In This Chapter

Understanding the different types of networks

Reviewing Network Address Translation

Discussing basic network architecture issues

Understanding subnets and switching

Analyzing firewalls

Reviewing intrusion detection

Understanding common attacks



Network Segments

Over the past few years, there has been a heavy integration of network technologies, which has created highly unified and global network architectures. Yet business, commercial, and military requirements demand segregation of network segments into authorized domains or network segments. The boundaries of such network segments are established by devices capable of regulating and controlling the flow of packets into and out of the segment, including the following:

- ♦ Routers
- ♦ Switches
- ♦ Hubs
- ♦ Bridges
- ♦ Multi-homed gateways

These segments can be theoretically classified into the following:

- ♦ Public networks
- ♦ Semi-private networks
- ♦ Private networks

Public networks

Public networks allow accessibility to everyone. The common Internet is a perfect example of a public network. On public networks there is a huge amount of trivial and unsecured data. Users normally pay for public network services and security controls on these networks are weak. Most of the networks you find at Internet cafés, airports, hospitals, shopping malls, and so on are examples of public access networks. Typically, security measures for public access networks are quite restricted. A one-time password would be all that is required to log into publicly available machines and public access networks. Despite the lack of security, large volumes of unprotected data are transmitted worldwide over public networks, because of their convenience and the variety of services they provide.

Semi-private networks

Semi-private networks sit between public networks and private networks. From a security standpoint, a semi-private network may carry confidential information but under some regulations. Semi-private networks are most often exclusive subnets of

large public networks such as the Internet. Large peer-to-peer networks that are designed to handle and share exclusive information (usually multimedia) among its users can also be classified under semi-private networks. A virtual private network uses public networks optimized with security features that only privileged users can use successfully.

Private networks

Private networks are organizational networks that handle confidential and propriety data. Each organization at every geographical location may own a private network. If the organization is spread over vast geographical distances, the private networks present at each location may be interconnected through the common Internet or other public networks. Generally, most commercial organizations prefer not to lay down dedicated lines over vast geographical distances, mainly due to cost factors. Private networks may have exclusive addressing and protocols and do not have to be compatible with the Internet. Address translation schemes and various tunneling protocols could be used to have incompatible private and public networks interoperate.

Perimeter Defense

In most cases, internal networks are composed of various network component blocks. Following are the most important of these:

- ♦ Application servers
- ♦ Proxy servers
- ♦ Middleware servers
- ♦ Data servers
- ♦ Presentation servers

Securing such enormous processing units often requires security solutions to be highly fortified at the network in addition to using individual server-based security systems. In most common environments, firewalls would be placed at the terminal ends of every network segment. Firewalls (independent or combined with routers) can be ideal choices for securing network perimeters. Demilitarized zones can be defined around the periphery for enhanced security features. Specialized application proxies normally placed at the boundaries of network environments can also function as perimeter defense systems. Figure 13-1 shows a comprehensive view of a network protected by perimeter systems (usually firewalls).

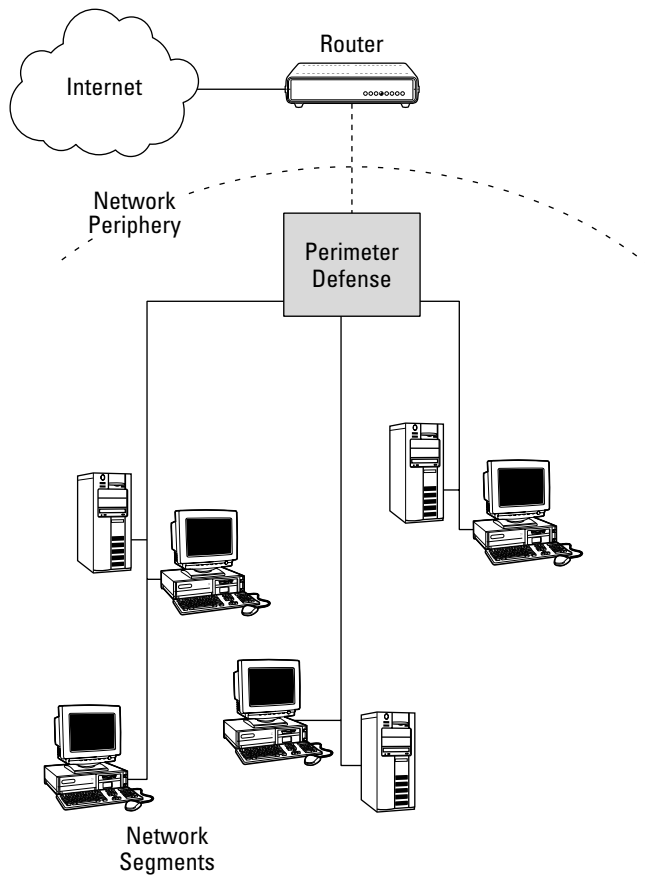

Figure 13-1: Perimeter defense strategies employed on various segments for an internal network

Network Address Translation

Network Address Translation (NAT) is a scheme employed by organizations to defy the address deficiency of IPv4 networking. It basically translates private addresses that are normally internal to a particular organization into routable addresses on public networks such as the Internet. In particular, NAT is a method of connecting multiple computers to the Internet (or any other IP network) using one IP address. Though NAT's main goal is to increase the scope of IP addresses (this necessity is addressed to a great extent by IP-v6 network architectures where there is an abundance of network addresses), security is an essential attribute that can potentially be achieved by NAT.

NAT complements the use of firewalls in providing an extra measure of security for an organization's internal network. Usually, hosts from inside the protected networks (with private address) are able to communicate with the outside world, but systems that are located outside the protected network have to go through the NAT boxes to reach internal networks. Moreover, NAT allows an organization to use fewer IP addresses in making entire networks operational, which aids in confusing attackers as to which particular host they are targeting; in this way security dimensions are increased. Many denial-of-service attacks such as SYN flood and ping of death can be prevented using NAT technology.

The main feature in NAT is the translation table that the NAT box maintains. A NAT box might be implemented with a laptop computer and the appropriate network interface cards. The translation table maps external unique IP addresses to internal private IP addresses. Normally, this mapping is not one-to-one. To conserve address space, a single global IP address may be mapped to more than one private IP address. Typically, port associations (on the NAT boxes) are created to achieve multiple mapping of public and private addresses. Any packets from the outside attempting to reach a particular host on the private network get routed with the NAT-specified global address. It becomes the responsibility of the NAT software to look up the translation table to find out the particular private address to which the packet has to be routed. Figure 13-2 shows the technique involved in NAT. Normally, translation tables are built using three methods:

- ♦ **Static**—In this configuration, the relationships among the global and private IP addresses are fixed.
- ♦ **Dynamic outbound packets**—In this mode, the translation tables get updated automatically as outbound packets are processed from the private network.
- ♦ **Domain name lookups**—When packets from the external Internet make domain name lookups of hosts inside the private network, the domain name lookup software takes the responsibility of updating the NAT tables.

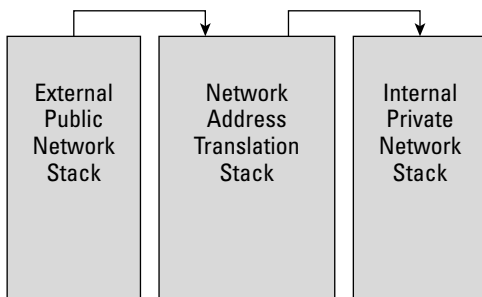

Figure 13-2: The NAT methodology

Basic Architecture Issues

Network architecture consists of various components. Each component has its own functionalities and responsibilities in effecting the various tasks involved in network communication. Many functions, such as quality of services, remote logins, security, and so on, require specialized components intended for a specific function or combination of functions. This section deals with certain building blocks (or components) that make the realization of these functionalities possible.

- ♦ **Demilitarized zone**—A demilitarized zone (DMZ) is a noncritical yet secure region generally designed at the periphery of the internal and external networks. Normally, the configuration of a DMZ is such that it is either separated by a firewall from the external network or sandwiched between two firewalls, one at the external periphery and the other at the internal. Figure 13-3 shows a demilitarized zone setup for a Web server application.

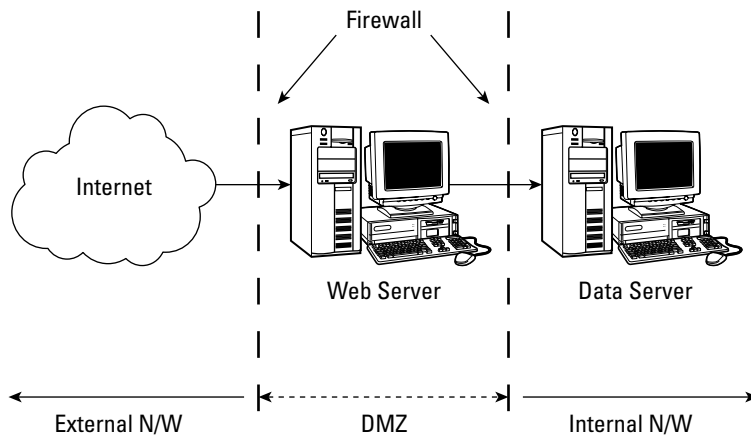

Figure 13-3: A Web server in a DMZ

- ♦ **Modems**—Modems (*modulators-demodulators*) are functional end user equipment that are used to transmit digital signals over analog telephone lines. Thus, digital signals are converted by the modem into analog signals of different frequencies and transmitted to a modem at the receiving location. The receiving modem performs the reverse transformation and provides a digital output to a device connected to a modem, usually a computer. The digital data is usually transferred to or from the modem over a serial line through an industry standard interface, RS-232. Many telephone companies (who offer DSL services) and cable operators (offering Internet cables) use modems as end terminals for identification and recognition of home and personal users.

- ♦ **Hubs**—A hub is a device for connecting multiple LAN devices together. It also performs as a repeater in that it amplifies signals that deteriorate after traveling long distances over connecting cables. Hubs do not perform packet filtering or any addressing functions.
- ♦ **Bridges**—Bridges are devices that are used to connect two or more hosts or network segments together. Bridges work only at the physical and link layer level and use the hardware Media Access Control (MAC) addresses for transferring frames. The basic role of bridges in network architecture is storing and forwarding frames between the different segments that it connects. Typically, a single bridge can have more than two ports, which means that more than two networking elements can be combined to communicate with each other using a single bridge.
- ♦ **Switches**—Network switches generally have a more intelligent role than hubs. Strands of local area networks (LANs), normally belonging to the same collision domain, are usually connected using switches. Mainly working on the Layer 2 frames (Data Link layer), they are equipped with the ability to read the packet headers and process appropriately. Generally, switches have the ability to read the incoming packets' hardware addresses to transmit them to the appropriate destination. Frames could be lost if a particular host is either unreachable or disconnected. Switches play an important role in regulating traffic regulations on the segments they interconnect. Because switches directly connect one of many devices connected to its input ports to one of many devices connected to its output ports, a switch necessarily has a larger number of input/output interface cards than bridges.
- ♦ **Routers**—Routers are one of the main components of the chassis of networks. Routers are mainly involved in the transmission of packets to their destinations, routing a path through the sea of interconnected network devices. The packets are removed from the incoming frames and individually analyzed. Routers normally work at the Network layer (Layer 3 of the OSI model), which assigns the much familiar IP addresses. IP addresses are software or logical addresses that point to a logical location or connection on a network. Worldwide IP addresses of any connection are unique unless they are not defined for private use. Routers normally process connectionless network layer packets, otherwise known as *datagrams*. Packets originating from the same source and reaching the same destination as part of the same connection may be routed through different routes. IP packets are equipped with header fields that give the routers knowledge of where it originated from and its intended destination. There is a plethora of work on routing algorithms. Routing algorithms are the knowledge base of the routers. Routers, which hop packets from one point to the other, use the routing algorithms for effecting their decisions. Bellman-Ford, Distance vector, OSPF, and so on are some well-known routing algorithms used on the Internet. Proprietary organizations can have their own implementations of these routing algorithms.

♦ **Gateways**—As you move up in the network protocol stack, you find gateways. Gateways normally work around the transport and session layers of the OSI model. Typically, on and above the transport layer, there are numerous protocols and standards proposed by different vendors. The Internet uses the Transmission Control Protocol (TCP) at the Transport layer, but other protocols (mostly proprietary) do exist in this layer. Some of the other Transport layer protocols include:

- X.25
- Systems Network Architecture (SNA)
- Asynchronous Transfer Mode (ATM)

Gateways are used when dealing with multiprotocol Transport layers and above. All of the following are important specifications at the gateway level of network architecture:

- Form factor
- Network type
- Performance
- Port
- Processor specifications
- Memory
- Features

Common features for network gateways include stackable, rack mount, LED indicators, integrated firewall, and Virtual Private Networks. Application layer gateways are ideal choices for integrating multiple security services. Firewalls and intrusion detection systems are ideally suited to be at this layer of the network stack.

Subnetting, Switching, and VLANs

Addressing is one of the main issues that network architecture is concerned with. Two major addresses are involved with all the major public access networks such as the Internet. They are the hardware (MAC) address and IP addresses. MAC addresses are used to uniquely identify individual machines as hosts and are not as important from a routing standpoint. They are hard coded into the network card and most people are not even aware what they are. The most important addresses seen all over the Internet are IP addresses. An IP address points to a logical entity on the Internet and is normally unique in identifying itself. Addressing in IP version 4 (IPv4) uses 32 bits. Rather than providing for random addresses for incoming hosts, the Internet follows a particular hierarchy that could be logically used for various vital services such as routing, name resolution, and so on.

IPv4 divides the whole address range into five major classes: Classes A, B, C, D, and E. The 32-bit address is split into three distinct regions, as follows:

- ♦ Class-ID
- ♦ Net-ID
- ♦ Host-ID

The class-ID is usually represented in the first to the fourth bits of an IP address. This is followed by the net-ID and then the host-ID. With such a scheme, it becomes easy to discern to what network and class a particular IP address's host belongs with the inspection of the address. This is highly useful when routing and resource discovery are in the picture. Figure 13-4 shows an IPv4 addressing representation. Classes A, B, and C are typically allotted to individual host depending on how big the particular network segment is. Classes D and E are for multicasting and future use, respectively. Class A encompasses a relatively small number of networks compared to class B and class C (which holds the most number of network addresses). Huge networks are generally addressed using class A, rather than class B and class C (which can hold the minimum number of hosts among the different classes).

Class

A	0	net-id	host-id
B	10	net-id	host-id
C	110	net-id	host-id
D	1110	Multicast	
E	1111	Reserved	

Figure 13-4: IPv4 class addressing

Subnetting is a technique followed in network architecture to reduce the burden of the routers in maintaining routing tables. Class B networks have approximately 64,000 different host addresses, though most organizations registered for class B addresses do not require that many hosts as they do not employ that many systems. In this case, many addresses get wasted and cumulatively there is a dearth of IP addresses with IPv4, because each network segment typically demands its own net-ID in the addressing scheme. Subnetting schemes are built in such a way that the traditional net-id/host-id barriers are broken so that any combination of addressing would fit per the size of the network. A subnet mask (a series of 1s followed by a series of 0s) is applied to the IP address to determine which subnet a particular destination is on in a particular network. This is a highly recommended feature for conserving addressing space and controlling router table explosions.

Switching is then done based on the resolved subnet address and host address. A new technique called *classless interdomain routing (CIDR)* offers new features in this regard.

Switching techniques can be used to incorporate interesting architectural twists in networking. One such network architecture concept is the virtual local area network (VLAN). This architecture is useful in situations where organizations have geographically distributed divisions or departments and would still like to place all the entities under a single network segment. VLANs make this possible. VLANs use switching to achieve same broadcast domain relationships. Figure 13-5 shows how virtual networking for four different LAN segments (A, B, C, and D) is possible using switching technologies.

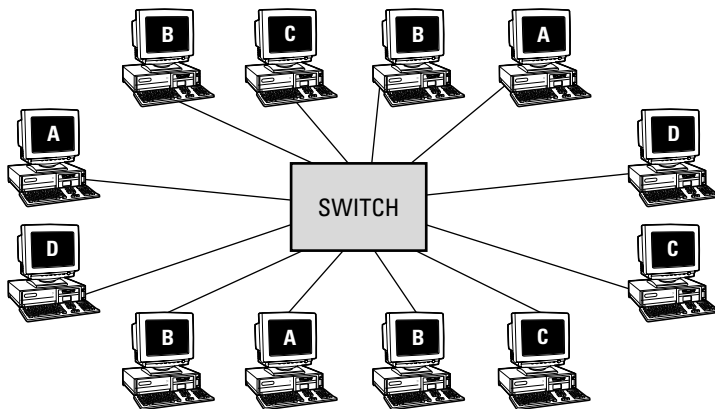

Figure 13-5: VLAN of four LAN segments (A, B, C, D) using a switch

Address Resolution Protocol and Media Access Control Addresses

The Address Resolution Protocol (ARP) and the Media Access Control are basically Layer 2 and 3 control issues in the Transmission Control Protocol/ Internet Protocol (TCP/IP) stack. It is impossible to associate individual IP addresses to every physical machine that has been manufactured. Instead, every machine can be uniquely identified by a second address called the Media Access Control (MAC) address, commonly known as a hardware address. The ARP is used to determine the 48-bit MAC address corresponding to a 32-bit IP address.

Normally, one would intend to use static translation maps to achieve this process, but the enormity of IP and MAC addresses available that must be maintained make it almost impossible for static maintenance. TCP/IP designers have a novel way of dynamically solving this problem using ARP. Normally, any host that requires determining the hardware addresses of a particular IP address broadcasts address request packets all over the domain it is in. The host whose actual IP address is found on the requests replies to the intended source of the presence of the particular host with its IP and MAC address. If no host can be determined, default routing actions are taken. This information can be used for further communication between the two hosts. To speed up the resolution process, a small segment of memory is maintained to store short-term IP and MAC address mapping of other hosts on the network. This memory is called the ARP cache.

The ARP cache is the first thing that a host looks at for address resolution before it can start issuing the broadcast process. Because two parties that were involved in communication at some point in time are likely to communicate at a subsequent time, cache memory becomes very vital in speeding up processing in the protocol. The ARP caches are required to be refreshed at regular intervals of time (approximately every 25 or 30 minutes). This is very vital in determining changes that have occurred in recent history. In hosts where storage mechanisms are not available, a similar protocol called the Reverse Address Resolution Protocol (RARP) is used for IP address determination at bootup. Figure 13-6 shows the pseudo data structure followed in ARP messages.

Hardware Type		Protocol Type
HD LEN	IP LEN	Operation
Sender Hardware Address		
Sender IP Address		
Receiver Hardware Address		
Receiver Hardware Address		

Figure 13-6: ARP message data structure

Dynamic Host Configuration Protocol and Addressing Control

The Dynamic Host Configuration Protocol (DHCP) is a commonly employed technique to distribute IP addresses on networks where static address allocation may not be appropriate. Auto-configuration IP address distribution techniques such as DHCP may be very easily done where centralized servers are commonly available. However, there is also a need for autoconfiguration in architectures where individual clients communicate directly with each other and there is no centralized service. An example of this type of communication in wireless networks is the ad hoc network. Ad hoc networks are infrastructureless, multihop wireless networks that can be deployed without any pre-existing setup. Ad-hoc networks are mobile in nature and any node can join and leave the network at any time. Due to their mobility, ad-hoc networks must be able to configure themselves without human intervention. Configuration (such as address assignment) of a node in such a network is a critical issue. The nodes in an ad-hoc network are basically a plug-and-play type, wherein any node can enter and exit a network configuration without much intervention from other nodes in the network. Zero-Configuration networks have a similar setup, but the main problem that arises when applying the techniques followed in Zero-Configuration networks to ad hoc networks is that a set of reserved IP address (169.254) exist for use in such networks, which may not be feasible for ad hoc network set ups. This section reviews some of the existing techniques for dynamic host configuration in ad hoc networks and their applicability.

The best method to assign IP addresses to network nodes in any network would be to assign them statically for each node in the network. This process could become highly tedious and vulnerable to errors for large-scale networks. This is one of the main reasons that DHCP was designed to automate the address assignment in IP-based networks. There are basically two modes of address assignment to a network configuration: stateful and stateless. In the stateful mode of configuration, a predefined set of IP addresses is dynamically issued either permanently or on lease to the individual nodes. In the stateless configuration (usually applied to IPv6 networks) a function of the hardware address is used to assign an IP address. For a variety of reasons, one generally cannot assign an IP address based on the MAC address even in IPv6 networks where one-to-one mapping of IP and MAC addresses is possible. For example, security reasons constrain the IP address to originate from a distinct set, and unavailability of unique hardware addresses is another reason. The fact that ad-hoc networks are dynamically configured, combined, and divided makes them quite unsuitable for stateless modes of auto-configuration. Moreover, the IETF has recommended that stateful autoconfiguration be implemented for ad-hoc networks. The mobile nature of ad-hoc networks makes devising a suitable mechanism for dynamic host configuration with a predefined set of IP addresses very difficult. It should be noted that mobility is quite different from connectivity. A network can be independent of physical hardware connectivity (a wireless medium, for example) and yet be nonmobile. Ad-hoc wireless networks combine these two aspects, independent connectivity and mobility, making it quite complex for most present-day configuration protocols.

Firewalls

For most enterprises, government institutions, and financial organizations, it is a necessity to safeguard their private networks and communication facilities. However, many organizations have application and financial demands that require them to place themselves on the Internet or other large-scale networks that are inherently insecure. The insecurity of such large-scale networks can lead to information mishandling, which could severely and negatively affect an organization. Thus, such organizations seek out network security establishments and other features to safeguard their internal networks and resources. As is evident from the many news stories of Internet viruses, worms, and identity theft, the public Internet is becoming a dangerous place. One of the best ways to arm against the malicious activities on an open network is to employ firewalls at the connection point of the insecure network and the internal network.

There are many reasons for an organization to employ firewalls to secure their networks from other insecure networks.

- ♦ **Poor authentication** — Most network services and applications do not directly use authentication and encryption features, as they could be too cumbersome or costly. When such applications are accessed from the outside, the applications themselves may not be able to distinguish between legitimate and fake users.
- ♦ **Weak software** — Most purchased software and free software, known as freeware (many of the commonly used remote login, file transfer, and e-mail programs), are not optimized for security features. Using them could create vulnerabilities in the respective networks. A firewall could be highly effective in scanning and logging Internet traffic using these applications.
- ♦ **Spoofing** — Address spoofing has been a security problem for a long time. Because routing commonly utilizes both source and destination addresses, it is relatively easier for an attacker to read packets of communication sessions and acknowledge the respective addresses. Once this is done, the hacker by sophisticated mechanisms can spoof the source address to the destination and vice versa. This can place resources directly under the control of the attacker who could wreak havoc in no time.
- ♦ **Scanners and crackers** — Scanners are usually network tools employed by an attacker to monitor and read network data and communication ports. When the attacker finds vulnerable ports or sensitive data, he or she would use these weak spots to initiate attacks on the network. Crackers are software programs that an attacker uses to launch dictionary attacks on passwords and other sensitive authentication information present on internal networks.

Figure 13-7 shows an example of a firewall placed between the Internet and an internal LAN to guard against attacks from the Internet.

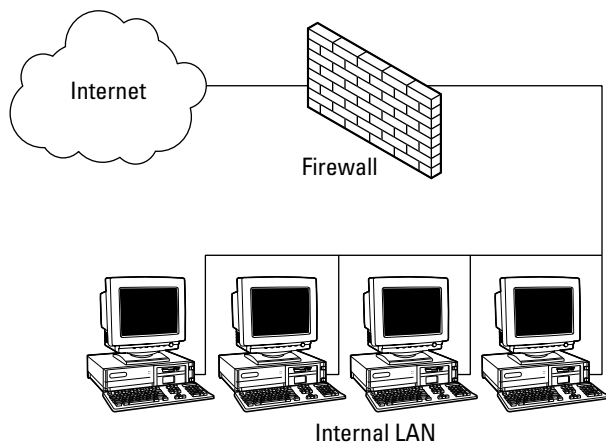

Figure 13-7: A firewall placed between the Internet and an internal LAN

Packet filtering firewalls

Packet filtering is one of the simplest and a primary means of achieving network firewalls. Filters are specialized components present in the firewall, which examines data passing in and out of the firewall. The incoming and outgoing firewall packets are compared against a standard set of rules for allowing them to pass through or be dropped. In most cases, the rule base (commonly known as the ruleset) is predefined based on a variety of metrics. Rules can include source and destination IP addresses, source and destination port numbers, and protocols used. Packet filtering generally occurs at Layer 3 of the OSI model and employs some of the following metrics to allow or deny packets through the firewall:

- ♦ **The source IP address of the incoming packets**—Normally, IP packets indicate where a particular packet originated. Approval and denial of a packet could be based on the originating IP addresses. Many unauthorized sites can be blocked based on their IP addresses; in this way, irrelevant and unwanted packets can be curtailed from reaching legitimate hosts inside the network. For example, a significant amount of spam and unwanted advertisements are aimed at third-party businesses, causing wastage of bandwidth and computational resources. Packet filtering using source IP-based rulesets can be highly effective in eliminating much of such unwanted messages.
- ♦ **The destination IP addresses**—Destination IP addresses are the intended location of the packet at the receiving end of a transmission. Unicast packets have a single destination IP address and are normally intended for a single machine. Multicast or broadcast packets have a range of destination IP addresses and normally are destined for multiple machines on the network. Rulesets can be devised to block traffic to a particular IP address on the

network to lessen the load on the target machine. Such measures can also be used to block unauthorized access to highly confidential machines on internal networks.

- ♦ **The type of Internet protocols that the packet may contain**—Layer 2 and Layer 3 packets carry the type of protocol being used as part of their header structure, intended for appropriate handling at the destination machines. These packets could be any of the following types:

- Normal data carrying IP packets
- Message control packets such as ICMP
- Address resolution packets such as ARP
- RARP
- Boot-up protocols such as BOOTP
- DHCP

Filtering can be based on the protocol information that the packets carry. Though packet filtering is accomplished at the OSI model's Layer 3 and below, Layer 4 attributes, such as TCP requests, acknowledgment messages, sequence numbers, and destination ports, can be incorporated in devising the filters.

- ♦ **Packet filtering firewalls integrated into routers**—Such routers route packets and drop packets based on firewall filtering principles. Information about the incoming port and out-going port in the router of the packet can be utilized to define filtering rules.

The main advantage of packet-filtering firewalls is the speed at which the firewall operations are achieved. Because most of the work takes place at Layer 3 or below in the network stack, complex application-level knowledge of the processed packets is not required. Most often, packet-filtering firewalls are employed at the very periphery of an organization's secure internal networks, as they can be a very handy tool in offering a first line of defense. For example, using packet-filtering firewalls is highly effective in protecting against denial-of-service attacks that aim to bog down sensitive systems on internal networks. The normal practice is to employ additional safety measures inside the DMZ with the packet filtering firewall set up at the external periphery.

Though cost effectiveness, speed, and ease of use are appreciable qualities of packet filtering techniques, it has some significant flaws, too. Because packet-filtering techniques work at OSI Layer 3 or lower, it is impossible for them to experiment with application-level data directly. Thus, application-specific attacks can easily creep into internal networks. When an attacker spoofs network addresses such as IP addresses, packet filters are ineffective at filtering on this Layer 3 information. Network address spoofing is a primary tool employed by willful attackers on sensitive networks. Many packet-filtering firewalls cannot detect spoofed IP or ARP addresses. In essence, the main reason for deployment of packet-filtering firewalls

is to defend against the most general denial-of-service attacks and not against willful attackers. Security inspections (such as cryptography and authentication) cannot be carried out with packet-filtering firewalls because they work at higher layers of the network stack.

Stateful packet filtering

Stateful packet-filtering techniques use a sophisticated approach, while still retaining the basic tenets of packet-filtering firewalls for their operation. In networking communication, Layer 4 works with the concept of *connections*. A connection is defined as a legitimate single-source transmitting and receiving to and from a single destination. The connection pairs can usually be singled out with four parameters:

- ♦ The source address
- ♦ The source port
- ♦ The destination address
- ♦ The destination port

Normally the Transmission Control Protocol (TCP) at Layer 4 of the OSI network stack uses such connection mechanisms for communication and, thus, differs from the connectionless Internet Protocol present at Layer 3.

Stateful inspection techniques employ a dynamic memory that stores the state tables of the incoming and established connections. Anytime an external entity requests a connection to a networked host, the connection parameters are characterized by the state tables. Similar to the packet-filtering techniques, certain rules are laid down that must be satisfied for legitimate conversation to take place. Because stateful inspection techniques involve higher-layer network information, the design has to be carefully crafted. When too many restrictions are placed on the firewall's behalf on the transiting data, customers and legitimate remote users may find it exceedingly difficult to surpass the firewalls. This can result in loss of business or poor productivity for commercial organizations.

Stateful inspection techniques use TCP and higher-layer control data for the filtering process. The connection information is maintained in state tables that are normally controlled dynamically. Each connection is logged into the tables, and, after the connection is validated, packets are forwarded based on the ruleset defined on the particular connection. For example, firewalls may invalidate packets that contain port numbers higher than 1023 to transit from application servers, as most servers respond on standard ports that are numbered from 0 to 1023. Similarly, client requests emanating from inappropriate ports can be denied access to the server. Figure 13-8 shows the stateful packet-filtering process.

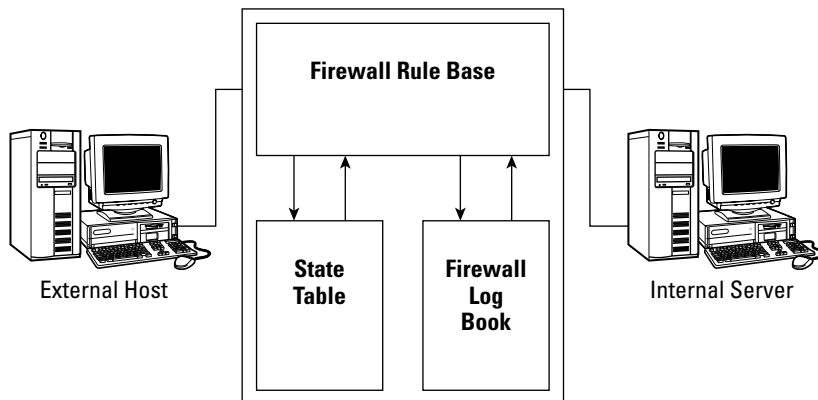

Figure 13-8: Stateful inspection firewall architecture

Even though stateful inspection firewalls do a good job of augmenting security features generally not present on filtering-based firewalls, they are not as flexible or as robust as packet filtering. Incorporation of the dynamic state table and other features into the firewall makes the architecture of such firewalls complex compared to that of the packet-filtering techniques. This directly influences the speed of operation of stateful inspection techniques. As the number of connections increases (as often is the case on large-scale internal networks), the state table contents could expand to a size that results in congestion and queuing problems at the firewalls. This appears to users as a decrease in performance speed. Most of the higher-level firewalls present in the market are state inspection firewalls. Other problems stateful inspection firewalls face include that they cannot completely access higher-layer protocol and application services for inspection. The more application oriented the firewall is, the narrower its range of operation and more complex its architecture becomes.

Proxy firewalls

Application proxy firewalls generally aim for the top-most layer (Layer 7—The Application layer in the OSI model) for their operations. A proxy is a substitute for terminating connections in a connection-oriented service. For example, proxies can be deployed in between a remote user (who may be on a public network such as the Internet) and the dedicated server on the Internet. All that the remote user sees is the proxy, so he doesn't know the identity of the server he is actually communicating with. Similarly, the server only sees the proxy and doesn't know the true user. The proxy can be an effective shielding and filtering mechanism between public networks and protected internal or private networks. Because applications are completely shielded by the proxy and because actions take place at the application level, these firewalls are very effective for sensitive applications. Authentication schemes, such as passwords and biometrics, can be set up for accessing the proxies, fortifying security implementations.

In many cases, dedicated supplementary proxies can be set up to aid the work of the main firewalls and proxy servers. Proxy agents are application and protocol-specific implementations that act on behalf of their intended application protocols. Protocols for which application proxy agents can be set up include the following:

- ♦ HTTP
- ♦ FTP
- ♦ RTP
- ♦ SMTP

The main disadvantage in using application proxy firewalls is speed. Because these firewall activities take place at the application level and involve a large amount of data processing, application proxies are constrained by speed and cost. Yet application proxies offer the best security of all the firewall technologies discussed here. Dedicated proxies can be used to assist the main firewalls to improve the processing speed. Figure 13-9 shows a comparison of the firewall technologies.

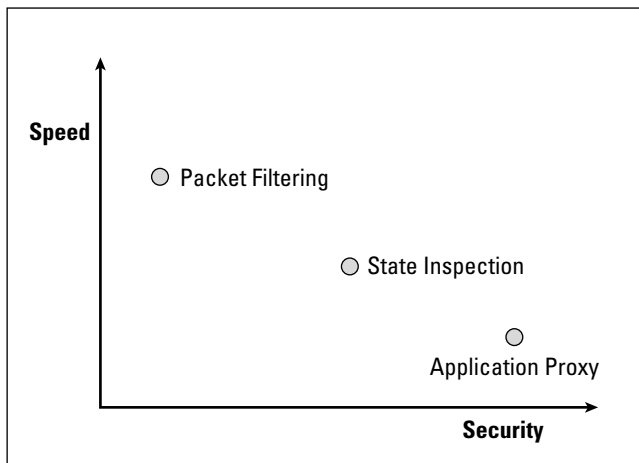

Figure 13-9: Comparison of firewall technologies

Disadvantages of firewalls

There are some inherent disadvantages of installing firewalls. The main disadvantage is the cost involved in installation. A thorough analysis of the protected architecture and its vulnerabilities has to be done for an effective firewall installation. Moreover, attackers can compromise the firewall itself to get around security measures. When firewalls are compromised by a clever attacker, he or she might be able to compromise the information system and cause considerable damage

before being detected. Attackers could also leave back doors that may be unseen by firewalls. These trapdoors become potential easy entry points for a frequently visiting attacker. When improperly configured, firewalls may block legitimate users from accessing network resources. Huge losses can result when potential users and customers are not able to access network resources or proceed with transactions.

Intrusion Detection Systems

Along with firewalls, intrusion detection is a main component of present-day security systems. The role of an intrusion detection system (IDS) is to attempt to trap a hacker's presence on a compromised network, to weed out any malfeasance as a result of the hacker's presence, and to catalog the activities so that similar attacks can be avoided in the future. An intrusion is technically defined as "an attempt by an unauthorized entity to compromise the authenticity, integrity, and confidentiality of a resource." Intrusions include the following types of attacks:

- ♦ Malign sensitive information on internal networks
- ♦ Appropriate confidential and proprietary information
- ♦ Dampen functionalities and resources available to possible legitimate users

IDSs are required to prevent problems arising out of an attack. Rectification of damage wrought by an attacker and the subsequent legal issues can be far more costly and time consuming than detecting the attacker's presence and removing him at an earlier stage. IDSs give a very good logged account of the means and modalities used by various attackers, which can be used to prevent and circumvent possible future attacks. Thus, present-day intrusion detection capabilities provide an organization with a good source for overall security analysis. The question as to what kind of intrusion detection system to deploy depends on the size and scale of the organization's internal networks, the amount of confidential information maintained on the network, and so on. From time to time, attackers will manage to compromise other security measures, such as cryptography, firewalls, and so on. It is crucial that knowledge of these compromises immediately flow to the administrators. Such tasks can be easily accomplished using intrusion detection systems. Negligence of administrators is a problem in network security. Deployment of intrusion detection systems can aid administrators in figuring out any missed vulnerability or exploits that a potential attacker could perform. Some of the commonly known IDSs include:

- ♦ Snort
- ♦ Cisco Secure IDS
- ♦ Dragon Sensor
- ♦ E-Trust IDS

- ♦ Audit-Guard
- ♦ Symantec
- ♦ Trip-wire

Types of intrusion detection systems

IDSs fall under many different categories depending on their functionality and architecture. Each type has its own specialized functionalities. An organization wishing to install an IDS normally goes through a comprehensive review of their needs and security requirements before choosing a suitable IDS. Basically, IDSs are classified under the following categories:

- ♦ Host-based intrusion detection systems
- ♦ Network-based intrusion detection systems
- ♦ Intrusion prevention systems

Host-based intrusion detection systems

Host-based IDSs are designed to monitor, detect, and respond to activity and attacks on a given host. In most cases, attackers target specific systems on corporate networks that have confidential information. They will often try to install scanning programs and other vulnerabilities that can record user activity on a particular host. A host-based IDS allows an organization or individual owners of a host on a network to protect against and detect adversaries who may incorporate security loopholes or exploit other vulnerabilities. Some host-based IDS tools provide policy management, statistical analysis, and data forensics at the host level.

Host-based IDSs are best used when an intruder tries to access particular files or other services that reside on the host computer. In most cases, the host-based IDS is integrated into the operating systems that the host is running. Because attackers mainly focus on operating system vulnerabilities to break into hosts, such placement of the IDS proves very beneficial. Historically, many host-based IDSs were installed on the respective hosts themselves, because no separate intrusion detection entity could be provided for large mainframes (which needed much security) in a cost-effective manner. This method caused some security bottlenecks. An intruder able to successfully overcome the IDS and the inherent security features of the host could disable the IDS for further actions. Such disadvantages are overcome when the IDS is physically separated from the hosts themselves. With the advent of personal computers and cheaper hardware accessories, separate entities for placing IDSs are favored (see Figure 13-10).

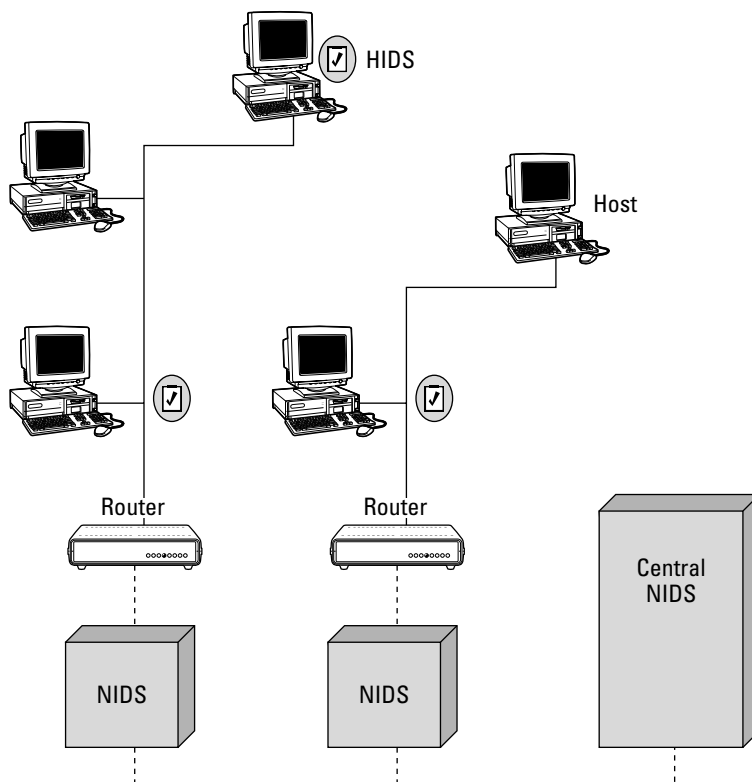

Figure 13-10: A centralized IDS

Network-based intrusion detection systems

Network-based IDSs capture network traffic (usually on the network as a whole or from large segments of it) for their intrusion detection operations. Most often, these systems work as packet sniffers that read through incoming traffic and use specific metrics to conclude that a network has been compromised. Various Internet and other proprietary protocols, such as TCP/IP, NetBEUI, XNS, and so on, which handle messages between external and internal networks, are vulnerable to attack and have to rely on additional means to detect malicious events. Frequently, intrusion detection systems have difficulty in working with encrypted information and traffic from virtual private networks. Speed (over 1 Gbps) is a constraining factor, though recent releases of network-based IDSs have the ability to work much faster. Figure 13-11 shows a representation of host-based and network-based IDSs deployed on networks.

Network-based IDSs can be centralized or distributed in control. In centralized control mechanisms, a central entity is responsible for analyzing and processing the logged information provided by the various constituent IDSs. The constituent systems can also be host-based IDSs. On the other hand, network-based IDSs can be on distributed architectures. Corporate networks can be spread over great distances. Some attacks target an organization's entire network spread over such big dimensions. Distributed systems could be integrated for performance and operations under such environments. Many features from distributed theory (such as cooperative agents) could be applied to realize operations under such IDSs. Cooperative agents are one of the most important components of distributed intrusion detection architecture. An agent, in general, is an entity that acts for or represents another entity. In the software area, an agent is an autonomous or semi-autonomous piece of software that runs in the background and performs useful tasks for another. Relative to IDSs, an agent is generally a piece of software that senses intrusions locally and reports attack information to central analysis servers. The cooperative agents themselves could form a network among themselves for data transmission and processing. The use of multiple agents across a network allows broader view of the network than may be possible with a single IDS or centralized IDSs. Figure 13-11 shows the architectural description of such distributed IDSs.

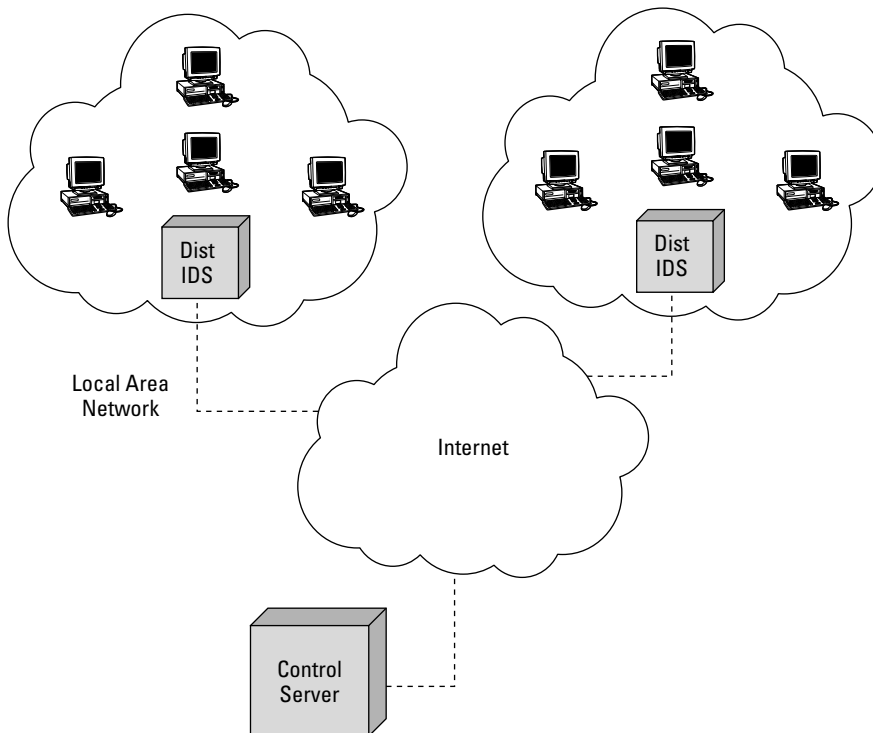

Figure 13-11: Distributed IDS

Intrusion prevention systems

Intrusion prevention systems are a sophisticated class of network security implementation that not only have the ability to detect the presence of intruders and their actions, but also to prevent them from successfully launching any attack. Intrusion prevention systems incorporate a harmonious medley of firewall technology and that of intrusion detection systems. One could view it as a successful integration of both security technologies for higher and broader security measures. Because intrusion prevention systems combine all levels of firewall and intrusion detection technologies, you often end up with systems that can operate at all levels of the network stack. However, the realization of an intrusion prevention system on an effective scale can be a costly task. Businesses need to assess their requirements and vulnerabilities before settling on this security solution. Moreover, intrusion prevention systems may not be as fast and robust as some of the conventional firewalls and intrusion detection systems. For this reason, it might not be an appropriate solution where speed is an absolute requirement. Intrusion prevention systems are a constant area of research and could be a sought-after technology in the future.

Methods and modes of intrusion detection

IDSs can operate in different modes. Essentially, the purpose of designing such modes of operation is to have a basis for analysis of network packets. These metrics can be used to deduce whether a particular network or system has been compromised or not. In most cases, the information collected indicates to the administrator whether or not further action needs to be taken. The most important of these modes are listed here:

- ♦ Anomaly detection
- ♦ Misuse detection

Anomaly detection

Anomaly detection is the process of scanning for abnormal activity that is encountered on the network. Most systems maintain a good log of the kinds of activities that take place on their networks and sensitive hosts. Such information can be used for comparison and contrast of all activity that takes place on the network. Unless administrators define static rules for new kinds of activity on the network, any deviation from the normal activity would be referred to as an *anomaly*. An IDS will alert network administrators when it encounters anomalous activity. A variety of metrics can be used for detecting anomalous activities. Some of the more prominent ones are as follows:

- ♦ Most often an IDS uses parametric curves to account for historical data that it has logged. In some case, learning curves can be devised from a design perspective to fit the log data. Any new activity that does not properly fit into such curves or that shows heavy deviation from normal curve projections can be classified as anomalous.

- ♦ Static rules can be set for file access, processor utilization, resource utilization, and so on from which anomalous activities can be inferred. For example, sudden and high utilization of CPU power on particular systems can be seen to be an anomaly. Extraneous processes could be a reason for the change in such processor activity. Permissible thresholds can be set for resource utilization and sensitive resources can be continuously monitored for anomaly. Many kinds of denial-of-service attacks can be weeded out under such a scheme.
- ♦ When a remote system intended for use by remote users shows activity locally, this could be cause for alarm. User systems that show activity at abnormal hours when the intended user, who may be designated to use the system, should not be logged in might also be indicative of abnormal activities.
- ♦ Port scanners are tools that an attacker can use to scan through a host's TCP or transport layer connection ports to evaluate host activity and find unused ports. One approach is to monitor normally unused ports present on a system. For example, if there is a sudden surge of activity on a particular port that has never been used, an alarm could be raised.
- ♦ In some instances, anomalies can be defined or modeled either statically or heuristically using soft computing techniques such as fuzzy logic, neural networks, evolutionary computing, genetic algorithms, and so on. The performance of such systems is usually high-end.

Even though anomaly-based IDSs are widespread and highly successful in most environments, they possess various disadvantages, too. The main drawback with anomaly-based systems is that they can raise a high proportion of false alarms. False alarms are raised when legitimate activity that differs from observed patterns of history occur. Anomaly-based IDSs can be very useful in creating and modifying signatures of user activity and accounts. Signatures are very useful metrics in misuse-based IDSs, which are discussed in the next section.

Pattern matching or misuse detection

Misuse detection is another method employed by IDSs. The main job of these systems is to compare activities with pre-generated signatures. Signatures are normally a set of characteristic features that represent a specific attack or pattern of attacks. Signatures are generated in most cases following an actual attack. Many commercial products store characteristic features of most of the known attacks that have been found and accounted for to compare them with future network activity. Sophisticated techniques, such as state-based analysis, are very useful in analyzing the signatures of attacks and the subsequent intrusion detection process.

Normally when misuse detection techniques are employed, highly skilled administrators are not required to infer an attacker's activity. It becomes very easy for a moderately skilled administrator to take evasive or remedial measures when attacks are detected by signature-based IDSs. In addition to the aforementioned advantages, misuse-based IDSs operate quickly and efficiently. Nonetheless,

because signatures are predetermined based on the past history of attacks and attacks that are already known, newer and covert attacks that do not fit the description of the designed signatures may succeed in passing through such IDSs. A high-profile survey of potential attacks and their signatures is required to make an effective design of such systems. This is reflected in the amount of cost involved in their architecture and implementation.

Detection issues

IDSs often have both accurate detections and missed attacks. Depending on the type of alarm raised by the IDS and the actual intrusion scenario, the following types of detection results are possible (Figure 13-12 shows a representation of the design issues):

- ♦ **True positive**— Occur when an actual attack occurs and the IDS responds to it by raising the appropriate alarm. Further action by the administrators to counter the attack is required when true positives occur.
- ♦ **True negatives**— Normal activity as expected by the administrators from the IDS. When no attacks happen, the intrusion detection system has no reason to raise alarms.
- ♦ **False positives**— Typically known as false alarms, these occur when an IDS reads legitimate or no activity as being an attack. This is a very serious drawback in intrusion detection systems.
- ♦ **False negative**— When a potential or genuine attack is missed by the IDS. The more occurrences of this scenario, the more doubtful the accountability of the IDS and its technology.

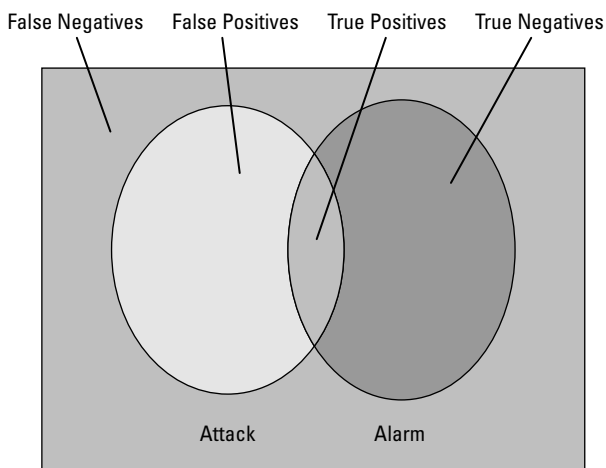

Figure 13-12: Detection issues in IDSs

Responses to Intrusion Detection

Intrusion detection systems demand various modes of responses when alarms are triggered. The degree of responses depends on the type of attack carried out and the type of alarm generated. Many false positive alarms do not require the administrator to respond, yet it would be beneficial to the administrator to log when false positive alarms occur so that the information can be used in the future. Both active and passive modes of responses can be incorporated into the systems, some of which are shown in the following list:

- ♦ **Block IP address**—IDSs can effectively block the IP address from which the attack originated. This scheme may not be effective against a vigilant attacker who spoofs the source IP address during his attacks. Nonetheless, blocking IP addresses proves very effective against spam and denial-of-service attacks.
- ♦ **Terminate connections**—The connections or sessions that the intruder maintains with the compromised system can be disrupted. RESET TCP packets can be targeted at the attacker so that he loses his established connections with the hosts. Routers and firewalls can be reconfigured to take appropriate actions depending on the severity of the intrusion.
- ♦ **Acquire additional information**—Active responses can include collecting information on or observing the intruder over a period of time. Audit logs and sensory mechanisms can be alerted to work more carefully during such information-gathering periods. The gathered information can be used subsequently to analyze the pattern of the attacker and make the whole IDS more robust. In addition, mechanisms can be devised to take legitimate actions against the intruder when sufficient knowledge about his origin is known.

Common Attacks

Many varieties of attacks can be detected using IDSs. Many of the attacks focus on altering user records and creating back doors for the attacker. Back doors serve as an entry point for attackers (the creator of the back door or others) to launch attacks at unexpected times. Vulnerability analysis deals with the detection and removal of such back doors so that they cannot be used as exploits. In most cases, the attacker wants some personal gains out of an attack. Attackers may target bank accounts and financial organizations with the intention of embezzling money. In such cases, personal profiling of the attacker is highly recommended. Some of the well-known attack types are as follows:



Common attacks are covered in detail in Chapter 17.

- ♦ **Denial-of-service** — Attacks intended to deprive legitimate users from accessing network resources and functions. Constant attempts to log on to a server by the intruder can slow down the server's processing abilities and decrease or eliminate its ability to service legitimate users. Financial organizations run the risk of losing disgruntled customers when such attacks are prevalent. A typical example of a denial-of-service attack is the ping of death. Ping-of-death attacks occur when an attacker causes a sudden surge in ping messages to a particular host or network. If the target system's processing power is not well protected, a huge amount of power could be wasted in responding to the ping-of-death attack. When the target system exceeds its processing threshold, the entire system collapses. Detriment to the capacity of resources such as memory, bandwidth, and so on can fall under this category.
- ♦ **Spam** — Another well-known mode of interrupting legitimate activity on a network. A user receiving a flood of spam messages has to sort out these messages from legitimate e-mail, resulting in decreased efficiency at many organizations. IDSs should be capable of figuring out and fixing the spam issue.

Note

A distributed denial-of-service attack is defined as a denial-of-service attack carried to more than one host. This happens when an attacker compromises a large number of geographically distributed hosts. The spreading of spam is an ideal task for such distributed denial-of-service attacks.

- ♦ **Scanning** — Scanning of network traffic or data may be another activity of interest to attackers. Scanning activities may be used to gain knowledge about the following:
 - System parameters
 - Host activities
 - Types of network on the secured system
 - Types of resources involved
 - Type of services provided
 - Operating systems used
 - Vulnerabilities present on the network

Port scanners and network scanners are common tools that an attacker uses for such activities.

Summary

This chapter reviewed some of the most important segments in the design of networks. Security is one of the fundamental constituents of any network realization. The initial portion of the chapter focused on building blocks on which typical, day-to-day public networks are built. The chapter mainly focused on how internal networks (particularly private networks) can be protected from general-purpose and public networks. Emphasis was placed on some of the leading technologies in security implementations such as firewalls and intrusion detection systems.



Communications

P A R T

IV



In This Part

Chapter 14

Secret
Communication

Chapter 15

Covert
Communication

Chapter 16

Applications of
Secure/Covert
Communication



Secret Communication

Many people think of cryptography as spies trading secret messages written with strange symbols that only the author and recipient of the message can understand. Some have even heard of terms such as cipher text or public-key encryption, but can't readily explain what they are. There are a lot of terms in cryptography, and even more mathematics, making cryptography often confusing. A lack of understanding can create a situation where both parties believe they are communicating securely when in actuality they are not. This is why even a basic level of understanding of cryptography can be helpful.

While cryptography is a vast and complex subject, a little knowledge about the field can be very helpful with respect to security. While a lot of security is the process of putting up walls to prevent an attack, or managing risk when an attack occurs, cryptography plays an important role in an overall security scheme. In security, where little can be proven secure, it is nice to know that at least one tool, cryptography, has mathematical proofs backing up the level of security. However, as with anything in math, these proofs only apply in specific situations, and it is often the case that people try to bend protocols or use cryptographic primitives in ways for which they were never intended; the result can be an insecure system.

While cryptography can be very secure when used properly, the human element of the process should always be considered. Sometimes, even if all the cryptographic algorithms used are secure and have been tested, a password left taped to a computer screen can void all security provided by cryptography. Although the human aspect of cryptography is not a focus in this chapter, it should always be kept in mind.

14 CHAPTER



In This Chapter

Cryptography terminology

Exploring symmetric cryptography

Exploring asymmetric cryptography

Learning hash

Uses and common practice of encryption



First, some general terms are introduced that are used throughout the chapter. Next, a short history of cryptography is provided to give some background as to who uses cryptography and classic ciphers. Then, the four basic cryptographic primitives are explained in detail with examples of real-life encryption algorithms and their uses. Finally, the differences between algorithms and implementations and between proprietary and open source are discussed.

Note

While this chapter discusses these primitives and how they fit into the overall use of cryptography, it is beyond the scope of this book to discuss how these algorithms were created or why they are believed to be secure. Breaking these algorithms is not discussed either.

General Terms

As with most subjects, understanding basic terms can help you understand the subject clearly, and cryptography is no exception. The terms defined in the following list pertain to cryptography and will be used throughout the rest of the chapter.

- ♦ **Brute-force attack**— This is the process of enumerating through all of the possible keys until the proper key is found that decrypts a given cipher text into correct plain text. Because all encryption is vulnerable to a brute-force attack, this type of attack is usually the upper bound of resistance the algorithm has. All encryption algorithms will eventually fall to brute-force attacks given enough time. It can be helpful, then, to see in the best case how long a piece of cipher text can remain cipher text, the idea being that if an algorithm's only attack vulnerability is through the use of brute force and there are enough possible keys to slow down such an attack, the algorithm can be considered secure. Algorithm strength is discussed in more detail later in the chapter.
- ♦ **Cipher text**— Data in its encrypted, unreadable form. Cipher text only refers to encrypted data and speaks nothing about the type of data before encryption, or the algorithm used to encrypt the data. Encrypted data is a synonym for cipher text.
- ♦ **Cryptanalysis**— The process of analyzing cipher text or the algorithms to find a weakness so that plain text can be extracted from the cipher text without the key. Cryptanalysis is done by cryptanalysts who use techniques such as frequency analysis, explained later, to find patterns in the cipher text.
- ♦ **Decryption**— Taking cipher text and using a key to convert it into plain text. In most cases, the algorithm or key used to encrypt the data is not the same as the one used to decrypt the data. Decrypting cipher text should not be computationally feasible without the proper key.

- ♦ **Encryption**—The process of taking plain text and using a key to convert it into cipher text. Ciphers, algorithms, or schemes are used to encrypt data. All encryption algorithms require the use of a key, and must be able, with the proper key, to be reversed, converting the cipher text back into the original plain text.
- ♦ **Key**—A random piece of data used with encryption and decryption. Encryption and decryption algorithms require a key and plain text or cipher text to produce cipher text or plain text, respectively. The key is usually shared only with those parties that should be allowed to encrypt and decrypt messages.
- ♦ **Plain text**—Refers to any type of data in its original, readable, unencrypted form. A text document, an image, and an executable are all examples of plain text. It is important to note that plain text refers only to unencrypted data.

Historic Cryptography

This section takes a brief historic look at the various types and uses of cryptography.

Substitution ciphers

Most people are unaware of the impact cryptography has had on the world and on their daily lives. As far back as Caesar, cryptography was used to protect messages. Caesar would encrypt his messages before giving them to messengers, protecting them from being read while in transit. Caesar used a simple method of encryption called a *substitution cipher*. A substitution cipher maps each letter in the alphabet to another letter. For example, the letter a might be mapped to z, b to y, and so on through the alphabet. Caesar used to replace each letter in the alphabet with the letter three letters to the left of it, wrapping around at the end of the alphabet. This mapping is shown in Figure 14-1, where the letters in the top row are the plain text letters and the ones in the bottom row are the corresponding letters in cipher text.

A	B	C	D	E	F	G	H	I	J	K	L	M	N	O	P	Q	R	S	T	U	V	W	X	Y	Z
Z	Y	X	A	B	C	D	E	F	G	H	I	J	K	L	M	N	O	P	Q	R	S	T	U	V	W

Figure 14-1: Caesar's encryption scheme

Using this encryption scheme, or cipher, if you were to encode the word cryptography, you would look up the letter c in the top row and find the letter z corresponding to it in the bottom row. Applying this process to all the letters yields the following:

Plain text: CRYPTOGRAPHY

Cipher text: ZOVMQLDOXMEV

Without the table trying to decode ZOVMQLDOXMEV into CRYPTOGRAPHY would seem like an impossible task. However, some cryptanalysts realized that breaking such a cipher was very easy; they needed only try 26 different substitutions or rotations of the alphabet before the cipher text would be converted into plain text, making sense of the words.

You might have noticed that this cipher does not have a key. In the definition previously given, an encryption algorithm requires both plain text and a key to create cipher text. It seems as though this algorithm requires only plain text to create the cipher text. However, this is not the case. The key in this algorithm is the table shown in Figure 14-1. This table acts as the key for the algorithm, mapping plain text letters to cipher text letters.

Vigenere cipher

To create a more secure encryption algorithm, Blaise de Vigenere in the sixteenth century proposed the Vigenere cipher. He created a cipher that works by using a keyword and substituting plain text letters for cipher text letters according to the keyword. However, instead of a simple rotation of the alphabet, Vigenere's cipher assigned a number to each of the letters in the alphabet and then used the value of each letter in the keyword to add to the value of each letter in the plain text, obtaining the cipher text. If the value of the two letters added together was larger than 26, 26 was subtracted from this value to obtain the cipher text character. This process was repeated for each letter in the plain text using the next letter in the keyword, and repeating the keyword as many times as needed to compensate for the length of the plain text.

The numbering for the alphabet was simple and always remained the same: a = 1, b = 2, and so on until reaching z = 26. A key was constructed for each message, instead of the Caesar cipher, which used the same key for each message, making it more secure. By creating a keyword with multiple letters instead of just a single letter rotation for the entire message, it had the effect of using as many different substitution ciphers as there were letters in the keyword. Using the same sample message, CRYPTOGRAPHY, and the keyword LUCK, the plain text is encrypted into NLAZEIIBLJJI as shown:

Plain text: CRYPTOGRAPHY

Key: LUCKLUCKLUCK

Cipher text: NLAZEIIBLJJI

Unfortunately, like the Caesar cipher, this cipher, too, was broken. To obtain the plain text from the cipher text by brute-force methods, trying all possible combinations, would take a very long time even with today's computers because the size of the key is not known. So, to attempt every possible keyword you would need to start with words that are of size 1, then words of size 2 (meaning begin with words that are one letter in length, then words of two letters in length), and so on. However, nothing specifies in the encryption algorithm that the keyword must be an English word. In fact, keys or keywords are often a random string of bits or letters, as you will see later. So attempting to crack this cipher would require going through all 26 letters in the alphabet with all different sizes of combinations up to the total size of the message (there is also nothing that states the keyword must be smaller than the plain text, only no larger). Assuming the keyword was no longer than 10 characters, and that only the 26 English letters were used, that would yield 146,813,779,479,510 possible combinations to try. Using a computer that could try a million keywords per second, it would still take four years to break the encryption.

Using a technique called *frequency analysis* Vigenere's cipher can be broken quite easily. One important property about the English language is that not all of the letters appear with the same level of regularity. For example, can you pick out what is very interesting about the following paragraph?

This is an unusual paragraph. I'm curious how quickly you can find out what is so unusual about it. It looks so plain you would think nothing was wrong with it. In fact, nothing is wrong with it! It is unusual though. Study it, and think about it, but you still may not find anything odd. But if you work at it a bit, you might find out! Try to do so without any coaching! You probably won't, at first, find anything particularly odd or unusual or in any way dissimilar to any ordinary composition. That is not at all surprising, for it is no strain to accomplish in so short a paragraph a stunt similar to that which an author did throughout all of his book, without spoiling a good writing job, and it was no small book at that. By studying this paragraph assiduously, you will shortly, I trust, know what is its distinguishing oddity. Upon locating that "mark of distinction," you will probably doubt my story of this author and his book of similar unusuality throughout. It is commonly known among book-conscious folk and proof of it is still around. If you must know, this sort of writing is known as a lipogram, but don't look up that word in any dictionary until you find out what this is all about. — Unknown

The interesting or amazing thing about the preceding paragraph is that it does not contain the letter e; however, e is the most commonly used letter in the English language. It is the fact that some letters are found with such precise regularity that messages encrypted using the Vigenere cipher can be decrypted without the use of the keyword. This is done by computing the *index of coincidence*. The index of coincidence is the probability that a letter in a string and a letter in the shifted version of the string appear in the same place. This is sometimes referred to as *autocorrelation*. To calculate the index of coincidence, you use the formula shown in Figure 14-2.

$$I_c(x) = \sum_{i=0}^s p_i^2$$

Figure 14-2: Formula for calculating the index of coincidence

This formula sums up the probability of a reoccurring character squared, where the summation runs from zero to the amount of shift. To apply this formula to breaking the Vigenere cipher, or any other substitution cipher, the index of coincidence is calculated for various shifts, s , starting at 1 (1 being the value or position of s) and working up. When an index of coincidence is found that is equal or close to that of English text (0.066), the key length, or the shift, has been discovered. This works because the key is repeated throughout the encrypting of the plain text. It is this repeating of the key that causes multiple characters in the message to be substituted by the same shifted alphabet. This reuse of the key is sometimes called *depth*, and it is very dangerous, making any otherwise good encryption algorithm insecure.

Note

If you take nothing else from this chapter, realize that the reuse of a key is the leading cause for encryption being broken (next to leaving the key or password taped to your monitor, of course).

Once the key length has been discovered, breaking the Vigenere cipher is done with frequency analysis and some brute force. English, like most human-created languages, has a precise repetition of letters. This fact allows us to compute the index of coincidence for English (0.066), allowing us to find the key length. It is this same frequency of letters appearing that enables the discovery of the key. Table 14-1 shows the frequency with which letters in the English language appear in text. This table was calculated by taking a large corpus of text and counting the occurrence of each letter.

Table 14-1
Frequency of Letters

Letter	Frequency	Letter	Frequency	Letter	Frequency	Letter	Frequency
A	8.50%	H	3.00%	O	7.16%	V	1.01%
B	2.07%	I	7.54%	P	3.17%	W	1.29%
C	4.54%	J	0.20%	Q	0.20%	X	0.29%
D	3.38%	K	1.10%	R	7.58%	Y	1.78%
E	11.16%	L	5.49%	S	5.74%	Z	0.27%
F	1.81%	M	3.01%	T	6.95%		
G	2.47%	N	6.65%	U	3.63%		

By setting the shift, s , to 25 and applying the formula for the index of coincidence, the index of coincidence for English text can be found, 0.066. The value for random text is 0.038. With the key length known, all the letters of the cipher text are broken up into strings. Each string represents a letter of the key. For example, if the key is four characters long, the cipher text is broken into four strings where the first letter of the cipher text is the first letter of the first string, the second letter of the cipher text is the first letter of the second string, the third letter of the cipher text is the first letter of the third string, the fourth letter of the cipher text is the first letter of the fourth string, the fifth letter of the cipher text is the second letter of the first string, and so on through all of the letters of the cipher text. This way, all the letters in a string are encrypted with the same letter of the key. Then each string is analyzed and a table like Table 14-1 is constructed for each string. Because the substitutions for each string are only a shift of the real alphabet, matching the English frequencies with the created frequency table for each string is usually easy. Keep in mind that all of this can be done in seconds, rather than years, with a computer. If one of the strings does not yield a frequency table that matches some shifted version of the English frequency table, brute force can be used to determine that string's shift. For example, when you piece back together the strings after all but two have been decrypted, it is usually easy to figure out the remaining characters from context of the other characters, another nice property of the English language.

Again, the key concept to take away from the Vigenere cipher is that reuse of the key can be a costly mistake. This is true for any cryptography system, no matter how simple or complex. What would happen, though, if the key was never repeated? What if the length of the key matched exactly the length of the plain text? How could the index of coincidence be calculated? The answer is that it could not. Using the index of coincidence to find the key length relies completely on the fact that the key is repeated. This brings us to a proven, 100 percent secure cryptography cipher, the *one-time pad*. The one-time pad uses the same basic cipher as the Vigenere, however, instead of having a key that repeats over and over to match the length of the plain text, it never repeats. The letters of the key are picked at random and have no correlation to the plain text. These types of ciphers are 100 percent secure because there is no cryptanalysis that can be performed to find patterns in the cipher text that can then be leveraged to obtain the plain text.

The one-time pad was used by the military to communicate covertly between field agents. Each agent was given a pad of paper that contained randomly selected numbers between 0 and 25. Two copies of each pad were made. One was given to the agent and the other was kept at the headquarters they were to communicate with. To encrypt a message, the agent shifted the position of the first letter of the plain text by the first number in the pad. The second letter of the plain text was shifted by the second number in the pad. This continued until all of the letters in the plain text were encrypted and the resulting cipher text was left. Assuming the numbers were randomly created, the cipher text was completely secure and only the agent and headquarters could decrypt the message. While this idea was completely secure, it had logistical flaws. The numbers could not be generated randomly and

they would repeat or have patterns that could be detected and reproduced by an agent who carelessly discarded part of the pad. Also, the pads were usually not long enough for more than a few messages. With the agents unable to obtain a new pad, they simply reused the pad starting from the beginning. This reuse of the pad, even across multiple messages, caused the same problem the Vigenere cipher had. This method, however, has been improved upon with the use of computers.

XOR and random number generators

Because the one-time pad is 100 percent secure a few logistical problems were overcome so that the method could still be used to securely communicate messages. Instead of simply rotating characters, a more modern approach was taken with the use of the *XOR function*. The XOR function is a binary operation performed on two strings of bits, and resulting in a third string of bits. This function is defined using Table 14-2. In general terms, whenever two bits are not the same the resulting bit is a 1, and when they are the same the resulting bit is a 0.

Table 14-2
The XOR Function

A	B	A XOR B
0	0	0
0	1	1
1	0	1
1	1	0

Instead of using simple addition, which had the problem of the resulting number being larger than the character set, XOR can be used in the same way as shifting with the same level of security, but without the problem of the result not mapping to a character. XOR also has a very nice inverse property just like addition. For example, $A \text{ XOR } B = C$, $A \text{ XOR } C = B$ and $B \text{ XOR } C = A$. If A represents a plain text character and B represent a key character, then C is the resulting cipher text after encryption using the XOR function. To decrypt, you simply reapply the XOR function to C and B or the cipher text and the key. Without the key it is impossible to know what the plain text was. All possible values can work for the key, but only one returns the proper results. If the key is just as long as the plain text, and the values generated for the key are done so randomly, this method of encrypting is perfectly secure.

However, there still remains one problem with using this method of encryption, the generation of perfectly random numbers or bit strings to be used as the key for XORing. This problem is not easily solved, because computers are deterministic

machines by design. The result of a computer operation is always the same, so generating random data is very hard. More important than the data being completely random is that the data cannot be predictable. If a few bits of the random stream are revealed to an attacker, a likely situation, the system still needs to be secure. This means that from knowing all previous random values the next value cannot be determined. The generation of random data is discussed further later in this chapter.

Ciphers that shaped history

The idea of substituting one letter for another carried on to World War II, where the Germans created a machine called Enigma that worked on the same basic principle of substituting each letter for another. However, instead of the substitution being simple, it was a complex set of substitutions that changed while the message was being typed. Rotors in the machine tracked these substitutions. It was the different speeds at which these rotors advanced and the ability to change rotors that provided the machine's security. While the machine was very complex and did a good job of encryption, it was the Germans' belief that letters in plain text should not be substituted for the same letter in cipher text that proved to be its downfall. This poor assumption and design decision greatly reduced the number of possible combinations for substitution making the machine weak. The U.S. was able to exploit this weakness and decrypt messages without the key, essentially breaking Enigma.

Following the Germans' lead, the Japanese created a machine called Purple. This machine was modeled after Enigma but used telephone stepping switches instead of rotors to create the character mappings. This machine proved very important in the war because it was used to encrypt diplomatic communications that hinted at the Pearl Harbor attack. This machine was also broken by the U. S. Government during World War II.

The Four Cryptographic Primitives

Cryptography is best understood by breaking it into four main areas or *primitives*. Using these primitives, or building blocks, all areas of cryptography are constructed. In fact, some of the primitives are used to build other primitives. For example, without the generation of random numbers it would be very hard to create secure keys for use in any of the symmetric or asymmetric encryption algorithms explained in this chapter.

All of cryptography is based on these four primitives, and the primitives are closely connected. With a full understanding of these primitives you should be able to read any standard that references them and understand protocols built using them. While the design and construction of cryptographic primitives should be left to the experts, it is important to know how they work and interact from a high-level perspective.

It is important to understand the goals of cryptography and these primitives. Cryptography provides three main properties using one or more of the following primitives. These properties are often discussed using the acronym CIA, which stands for *confidentiality*, *integrity*, and *authentication*. These properties, as they relate to cryptography, are defined here:

- ♦ **Confidentiality** — Only the parties that should be able to obtain the information are able to obtain it. This relates closely to the decrypting of messages by attackers. If an attacker can decrypt a message without the required key, confidentiality is not achieved.
- ♦ **Integrity** — Data has not been modified or changed in any way, deliberately or otherwise. If data has not been modified, integrity of the data has been achieved. Changes both known and unknown are included in the definition because things such as network errors are considered a breach of integrity even though they are not a deliberate attack.
- ♦ **Authentication** — The proposed source of the data can be verified to be true. Data that is delivered from one source to another has achieved authentication if the sender of that data can be proven.

The four basic cryptographic primitives are as follows:

- ♦ Random number generation
- ♦ Symmetric encryption
- ♦ Asymmetric encryption
- ♦ Hash functions

Sometimes it is enough to use a single primitive alone to obtain one of the CIA goals; however, most of the time these primitives are used in conjunction to obtain the CIA goal. For example, it requires all four of these primitives together to complete the task of using a credit card to purchase merchandise from a secure Internet site.

Random number generation

The first cryptographic primitive is the generation of random numbers or, more accurately, random bit strings. While completely random numbers can never be generated from a computer algorithm alone, there are algorithms that create pseudorandom numbers, or numbers that appear to be random. It is the ability to generate pseudorandom numbers that provides keys for all of the encryption algorithms explained later. Even the simplest encryption algorithms, such as the one-time pad, require the generation of pseudorandom numbers.

The numbers created from cryptographic pseudorandom number generators do not have to be 100 percent random; they simply have to be unpredictable to an

attacker. If an attacker can recreate the stream of bits used to create the keys for any encryption algorithm, it is as if you have given the attacker your key. By recreating the stream of bits used to create the key, an attacker can recreate the key using the same method because all good encryption algorithms are published (more on this later in the chapter).

Because creating truly random numbers is not possible on a computer, many interesting techniques have been used to get seemingly random numbers. There are two basic approaches to generating pseudorandom numbers on a computer. The first is to design an algorithm that will create what appears to be random numbers. The main problem with this approach is that at some point the algorithm will cycle and you will start seeing the same numbers in the same order. As previously mentioned, this is called depth and is very dangerous because the repeated bit stream makes it easy to break encryption.

Algorithms for pseudorandom number generation

The most basic pseudorandom number generation algorithm is the linear congruent pseudorandom number generator (LCG). This algorithm is a simple function that has as parameters a , b , and n . These parameters characterize the output of the function and should be kept secret. There is also a seed value, which is the first value of the pseudorandom stream. It quickly becomes a chicken-and-egg problem because the seed should be a random number itself. So how do you generate a random seed without a random number generator? The answer is not a simple one, but elements such as time, hardware serial numbers, and so on are all combined to generate a pseudorandom seed. The function for an LCG is shown in Figure 14-3.

$$x_i = ax_{i-1} + b \pmod n \text{ where } x_{i-1} \text{ is the seed}$$

Figure 14-3: The LCG function

Unfortunately, this pseudorandom number generator is not cryptographically secure. With only a few numbers, the parameters to the function (a , b , n) can be determined, leading to the creation of the same pseudorandom numbers in the same order. While this algorithm is not cryptographically secure it was included because it is a frequently used pseudorandom number generator in simulations and is sometimes incorrectly used in cryptographic situations creating a weak or guessable key.

Two pseudorandom number generators that are cryptographically secure are the Blum-Blum-Shub pseudorandom generator and the RSA (which stands for Rivest, Shamir, and Adleman, its inventors) pseudorandom generator. Both of these algorithms rely on a number of theoretical properties that are outside the scope of this book. However, these algorithms are believed to be secure because they require the factoring of large numbers to be broken, and this is believed to be computationally infeasible if the number is large enough. Both algorithms are outlined here.

Note

For an in-depth explanation of these algorithms, refer to *Handbook of Applied Cryptography*, by Menezes, Oorschot, and Vanstone.

The basic steps in the Blum-Blum-Shub pseudorandom bit generator are as follows:

1. Generate two large distinct primes, p and q , congruent to 3 mod 4.
2. Compute $n = pq$.
3. Select a seed, x_0 , from the interval $[1, n - 1]$ such that $\gcd(s, n) = 1$.
4. Let $x_i = x_{i-1}^2 \bmod n$, the low order bit of x_i is the pseudorandom bit.

The basic RSA pseudorandom bit generator steps are as follows:

1. Generate two RSA primes, p & q , and compute $n = pq$ and $\Phi = (p - 1)(q - 1)$.
2. Select a random integer e from the interval $(1, \Phi)$ such that $\gcd(e, \Phi) = 1$.
3. Select a seed, x_0 , from the interval $[1, n - 1]$.
4. Let $x_i = x_{i-1}^e \bmod n$, the low order bit of x_i is the pseudorandom bit.

While neither of these algorithms creates truly random bits, they do create unpredictable bits, making them good generators for use in key creation. However, like the LCG, keeping the parameters used for these generators private is very important. Giving away p and q for either generator will allow an attacker to recreate the stream of pseudorandom bits, enabling the attacker to recreate the key.

Using user input to generate numbers

The second approach to creating random numbers on a computer is to track some sort of user input. One common method is to record input from the keyboard and the mouse. These types of programs will ask the user to push random keys on the keyboard and move the mouse around the screen in a random fashion. The idea is that a human mashing the keys of a keyboard or moving the mouse around the screen will be able to create random enough data for key generation. Remember the numbers do not need to be completely random, only nondeterministic, and wild movements of the mouse usually are nondeterministic. The recorded values are then fed into a hash function or stream cipher (both hash function and stream cipher are explained later) to create pseudorandom numbers. Computer device access times are also used to create pseudorandom numbers. The time at which your hard disk is accessed and the time at which packets are received by your network card are all fed into a mixing function and pseudorandom bits are computed. While these methods might not produce completely random bits, they are usually unpredictable enough to prevent an attacker from recreating your key.

Whitening functions

Even with the seemingly random mashing of the keyboard and movement of the mouse, there is still some predictability to the values created. This is why these values are put through a mixing and whitening function. A mixing function's goal is to take somewhat random numbers or bits and map them into seemingly random bits. Whitening functions make sure that an even number of ones and zero bits are produced from the pseudorandom bit generator. While mixing functions are usually stream ciphers, block ciphers, or hash functions that are very complex; whitening functions can be very simple functions. Von Neumann created the most classic and simple whitening function. This function works by observing two bits at a time and generating one whitened bit half of the time. The function works as shown in Table 14-3.

Table 14-3
The Whitening Function Operation

<i>X</i>	<i>Y</i>	<i>Output Bit</i>
x_i	x_{i+1}	z
0	0	nothing
1	0	1
0	1	0
1	1	nothing

Only when the bits are different is 1 the output. Then the first bit is used as the output bit as shown in the preceding table, where z is the output bit. This function reduces the bit basis on a single bit level because only when there is a change in bits, from a stream of 1s to a stream of 0s, is a bit output. While this function helps to remove bias on a single-bit level, it does nothing to remove bias on a multiple-bit level. This function does not help to create random or pseudorandom bits; it creates only a uniform distribution of bits on the single bit level.

Examples of this method of pseudorandom bit generation can be seen in both Windows and UNIX/Linux operating systems. In the Windows operating system, the function `CryptGenRandom` found in the Crypt application program interface (API) generates its random bits by tracking user interrupts and then feeding these values into RC4, a stream cipher. In UNIX/Linux operating systems, user interrupts are also monitored, and they are put through the SHA-1 hashing function to further mix the bits and help to whiten them. These values can then be found by reading from

/dev/random or */dev/urandom*. The only difference between the two is that */dev/random* keeps an estimate of how much entropy or randomness is in the pool and will only allow reads when the level is high enough, whereas */dev/urandom* will continue to generate bits by simply rehashing the pool for more random bits. For this reason, */dev/random* is considered a more secure source of random bits than */dev/urandom*.

Cast Introduction

Before explaining the next cryptographic primitive, symmetric encryption, it is a good idea to introduce some people that will be used throughout the rest of this chapter. The following are used to designate actual people or computers. The names chosen are not unique to this book; in fact, almost all cryptography explanations use these names. The reason for the names is no more complex than the first letter of their names. Instead of saying, “Computer A sends a message to computer B,” “Alice sends a message to Bob” is used instead. The cast of characters is as follows:

- ♦ **Alice** — She is an end user/computer without malicious intentions, one of the main users of cryptography.
- ♦ **Bob** — He is Alice’s friend and is also a main user of cryptography, without malicious intentions.
- ♦ **Cathy** — Another user of cryptography; she does not usually have a large roll nor malicious intentions.
- ♦ **Eve** — A malicious user that does not interfere with communications. She simply wants to eavesdrop on the conversation between two other characters, typically Alice and Bob, but does not actively try to attack the communication.
- ♦ **Mallory** — The malicious user. Always trying to thwart attempts by other characters to communicate securely.
- ♦ **Trent** — He is a trusted third party. He only communicates with Alice, Bob, or Cathy when they ask for his help. He can always be trusted to do what he says he will do.

These characters are used throughout the rest of this chapter. Familiarize yourself with them because they will often be used to describe a cryptographic protocol without further definition. It is assumed you know that Trent is a trusted third party, for example.

Symmetric Encryption

Symmetric encryption, or single-key encryption, is the most basic and well-understood cryptography primitive. It is where the whole field really started.

Caesar and his cipher; the Germans and Enigma; and the Japanese and Purple are all examples of symmetric encryption. The idea behind symmetric encryption is that only a single key is used to encrypt and decrypt a message.

Symmetric encryption is used when Alice wants to provide confidentiality of a message sent to Bob. Alice wants the message, or data, to remain secret to everyone except herself and the recipient, Bob. This is the main property that symmetric encryption provides. Depending upon the mode of encryption used (modes are explained later in this chapter), symmetric encryption can also provide integrity when used correctly.

The best analogy for symmetric encryption is that of a safe. To unlock a safe you must have the right key. In the physical world this key is usually a metal object. In the world of cryptography, this key is a set of random bits. If you have the key, you can open the safe and put something inside of it. In the world of cryptography, the only thing you can put into the safe is data, and you do so by encrypting it. Now whatever is inside the safe is confidential and protected from anyone without the key. Without the key, Mallory is unable to read, modify, or do anything to the data except destroy it.

To unlock the safe you must have the proper key. The same is true with symmetric cryptography; Alice or Bob must have the correct key to decrypt the data. Much like a real safe, the key that was used to encrypt the data is the same key used to decrypt. If you do not have the proper key, you cannot decrypt the message, or data. Just like a real safe, however, attempts by Mallory can be made to decrypt the message without the proper key. In our safe example, this can be done by going through all possible physical configurations for a key until the proper configuration is tried and the safe is opened. In cryptography the same is true. Mallory can try all possible key combinations until one works, and the resulting data or message is understandable. You might be asking yourself, how many combinations would they have to try? The answer to that question depends upon the encryption algorithm or cipher used.

Note

The key used to encrypt and decrypt is sometimes not exactly the same, but you can always derive the decryption key from the encryption key without much work. Reversing the encryption key is a normal method for obtaining the decryption key.

This also brings up a term that might be unfamiliar but is often used to talk about an algorithm's security: *computationally secure*. Computationally secure means that the amount of time needed to compute all possible combinations is so large that it cannot be done in any reasonable amount of time. The definition, "in a reasonable amount of time," is deliberately vague because computationally secure is ever changing as the speed of a computer is ever increasing. For example, one popular symmetric encryption algorithm, Data Encryption Standard (DES), has a key of 56 bits. This means that for someone to break the algorithm it would require $2^{56} = 72,057,594,037,927,936$ different keys to be tested to exhaust all possible keys.

Assuming your computer could try a million keys a second, it would take 2284 years to try all of the keys. That sounds like it is a secure algorithm because we will all be dead by the time the key is discovered. However, a specially built machine was used to crack DES in a little over 36 hours. With unlimited funds and current technology, DES might be able to be broken in only a few hours. It is this change in computer speed that makes the definition of computationally secure ever changing. What is computationally secure now, at the time of this writing? This is a heavily debated question, but something that requires around 2^{80} attempts (keys) is considered beyond the computational ability of any computer in existence today. However, remember that what is out of reach today might become very easy to compute tomorrow.

In the area of symmetric key cryptography, there are two main types of algorithms that use only a single key: stream ciphers and block ciphers. They differ only in the way that the data is processed.

Stream ciphers

A stream cipher uses a single key to encrypt a message or stream of data. The message is considered to be a stream of data in that each byte is processed with the bytes preceding it, and that order is important. If you were to change the order of any of the bytes in the plain text, the cipher text, from that point forward, would look different. Figure 14-4 shows what a stream cipher does.

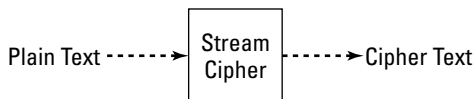

Figure 14-4: A stream cipher

Stream ciphers normally do not require any padding of the message. Because messages are treated as a stream of data they can be of any length and do not need to be padded in any way except to add randomness to common messages.

You have already seen one type of stream cipher, the one-time pad. Other stream ciphers include the following:

- ♦ RC4
- ♦ SEAL
- ♦ ISAAC
- ♦ PANAMA
- ♦ Helix

There are a lot of stream ciphers and most of them work by generating seemingly random data using the key as the seed for the generator. Then this stream of data is XORed with the message just like with a one-time pad, and the cipher text is created.

When Alice wants to send a message to Bob using a stream cipher, they must both have the same key. This is true for any symmetric key encryption; however, the other caveat for using stream ciphers is that they must feed the plain text and cipher text into the algorithm in the same order as it was produced. Order is very important when using stream ciphers. Mallory can prevent Bob from decrypting most stream cipher-encrypted messages by changing the first few bits that Alice sends to Bob. This property of a stream cipher is not a bad thing, though; it provides integrity. If any of the cipher text bits are changed, it will be obvious to Bob when he decrypts the message. However, there are plenty of stream ciphers where errors do not propagate through the entire message. What this means is that if an error occurs while the message is being sent from Alice to Bob, it will only prevent that section of the message from being decrypted properly. This property is an important one to consider if the channel used to communicate is not reliable.

Block ciphers

A block cipher is the other kind of symmetric encryption algorithm. Block ciphers also use a single key to encrypt a message, but it is done a block at a time. A block is considered a certain number of bits and is determined by the algorithm. Each block is processed independently of each other and there is no correlation between the encrypting of one message block and another. It is the ability of a block cipher to process a single message block at a time that makes it different from a stream cipher. Figure 14-5 shows what a block cipher does.

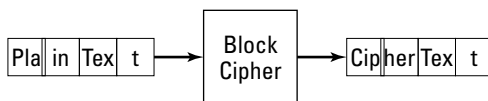

Figure 14-5: A block cipher

While block ciphers have the ability to process a single block of the message independently, usually encryption modes are used to break this property to prevent someone from gaining information about the message by seeing repeated blocks. For example, if Alice sends the message “yes” to Bob in response to a question, the word “yes” will be encrypted to the same cipher text assuming the same key is used. Then every time the word “yes” was sent, Eve would know what message was being sent without needing to decrypt it. Worse yet, Mallory could pre-compute the message “yes” with all possible keys and then simply match the cipher text seen to the cipher text of a pre-computed message. This would allow Mallory to know the corresponding key and break all further encryptions, assuming the key size is small enough.

Another attack that Mallory can use is to change the order of blocks. This will not prevent decryption from occurring, as would happen with a stream cipher, because each block does not depend on any other block. For example, suppose Alice asks Bob what house number his house is and his response is “1234,” encrypting “12” in one block and “34” in another. Without knowing what house number was actually sent, Mallory can still change the ordering of the blocks and send Alice to “3412,” the wrong house. So while an error in one block of cipher text does not propagate to further blocks, Mallory can still change the ordering of the blocks without Bob or Alice knowing. This still implies that there is confidentiality; however, integrity is now lost using a block cipher this way.

To break this property of the same plain text block always encrypting to the same cipher text block, modes of encryption were created. The first mode of encryption is the one already explained, simply encrypting block by block through the plain text. This mode of encryption is called electronic code book. Three other common modes are used: cipher block chaining, cipher feedback, and output feedback. While these three modes break the property that the same plain text is encrypted to the same cipher text, they come with the disadvantage that any error will propagate throughout the encrypting process much like a stream cipher. The level of error propagation is different for each mode. They are outlined as follows:

- ♦ **Electronic code book (ECB)**— The message is encrypted one block at a time so that one plain text block maps to one cipher text block. An error in any block only effects the decryption of that block. If an entire block is lost during transmission, none of the other blocks are affected.
- ♦ **Cipher block chaining (CBC)**— The output block of the previous encryption is XORed with the next block of plain text before being encrypted. If an error occurs in one block, that error is propagated into the next two blocks that are deciphered. If an entire block is lost during transmission only the next block is affected during decryption.
- ♦ **Cipher feedback (CFB)**— The previous cipher text block is encrypted and the result is XORed with the plain text block. This differs from CBC mode in that the XOR occurs after the encryption of the previous cipher text block. If an error occurs in one block, that error is propagated into $\lfloor n/r \rfloor$ blocks where n equals the output size of the block cipher and r equals the number of bits used in the XOR. If an entire block is lost during transmission, CFB mode will recover just like CBC; however, it requires $\lfloor n/r \rfloor$ blocks before the error is removed.
- ♦ **Output feedback (OFB)**— The output of the encryption algorithm is continually fed into the algorithm while the plain text is XORed with this output. This differs from CFB because what is fed into the encryption algorithm does not include the cipher text. If an error occurs in one block, that error is only propagated to those bits that are changed. However, if any of the bits are lost, including a whole block, the error is propagated to all of the remaining blocks and cannot recover.

Of all the modes shown in the preceding list, ECB is almost never used because of the reasons stated. The most popular mode is CBC because errors do not propagate throughout the entire message if bits are lost like they do in OFB. CBC is used over CFB because the error propagation is usually smaller, only two blocks, and because the bit changes that do occur happen in a predictable manner to the later blocks. For example, when using CBC, if block 1 has bits flipped in it during transmission, block 1 will be seemingly random, and block 2 will have the exact bits flipped where they were in block 1 during transmission. This enables Mallory to cause predictable changes to the message. In CFB mode bits flipped in block 1 are the exact bits that are flipped in block 1 of the decipherment. The later blocks then appear random. If an attacker is going to flip bits while the cipher text is being transmitted, it is always better to receive a random-looking block on decryption alerting you that this has occurred and to not trust anything that comes after it. This is not true for CFB, because you cannot necessarily tell where the error begins, only that one has occurred.

DES (mentioned already) is only one of many block ciphers. DES was the original block cipher backed by a National Institute of Standards and Technology (NIST) publication. However, because of the small key size, 56 bits, it was only thought to last for 5 years because computers today can quickly perform a brute-force attack against 56 bits. About 15 to 20 years later, talk of a new algorithm was brought up at NIST. They took submissions for the new algorithm to be called *Advanced Encryption Standard* (AES). The hundreds of submissions were whittled down to a final five, and then finally an algorithm called Rijndael was selected to become AES. AES has three key sizes: 128, 192, or 256 bits. Other block ciphers include but are not limited to the following:

- ♦ Desx
- ♦ Blowfish
- ♦ Cast
- ♦ Skipjack
- ♦ Twofish

There are many, many more.

Sharing keys

With strong block ciphers created, the ability to use them is still hindered by the fact that the key must be known by both parties before the algorithm can be used. Often, the other party you are going to communicate with is known, so keys can be created and shared in a secure manner before communication begins. This type of key generation is called using a *pre-shared secret*. The key is shared between parties before communication begins. However, what if Alice wants to communicate with

Bob and she has never met Bob before, so they do not have a pre-shared secret key? How then can Alice and Bob communicate securely? They could create keys and encrypt them so no one knows the keys, but how are they going to encrypt them without common keys? Again, we are back at the chicken-and-egg question.

One way to solve this problem is to have a trusted third party, Trent. Alice will create a key to be used to communicate with Bob. She will encrypt this key using a pre-shared key that she has with Trent and then send the key to Trent. Trent will then be able to decrypt the key he received from Alice using her key and then encrypt with the key he has pre-shared with Bob and send it to him. Now both Alice and Bob have a common shared key, and only Trent, Alice, and Bob know what the key is. However, this scheme has problems, starting with Trent. What if Trent is really not Trent at all but Mallory? Now she has the key and can decrypt any communication between the two parties. Also, this scheme requires that everyone have a pre-shared key with Trent. Implementing a system like this would be a huge logistical problem.

Another way to share a key between two parties is for the parties to create the key on the fly, in a secure manner. This idea is called *key agreement*. One classic key agreement protocol is the Diffie-Hellman key agreement protocol. This protocol has each user send the other a message. Once both parties have the other's message a secret key has been established between the two, and any third party, Eve, cannot obtain the key even if she knows both messages. This protocol relies on a number theory called the *discrete logarithm problem*. Explaining this hard problem in detail, however, is beyond the scope of this text. The protocol is briefly outlined for you here:

1. A prime, p , and an integer, a , such that $(2 \leq a \leq p - 2)$, are created and openly published.
2. Alice \leftrightarrow Bob: $a^x \bmod p$ where x such that $(1 \leq x \leq p - 2)$ and is kept secret by Alice.
3. Bob \leftrightarrow Alice: $a^y \bmod p$ where y such that $(1 \leq y \leq p - 2)$ and is kept secret by Bob.
4. Bob receives $a^x \bmod p$ and computes the secret key: $k = (a^x)^y \bmod p$.
5. Alice receives $a^y \bmod p$ and computes the secret key: $k = (a^y)^x \bmod p$.

It is easy to see that both of the keys will be the same. It is not so easy to see why a person cannot figure out x and y from the two messages. Essentially, you need to take the logarithm of the messages to obtain x and y ; this is very hard to do modulo p . If the integers used are large enough, 512 bits or larger, it is computationally infeasible to compute this discrete logarithm and therefore computationally infeasible to break this key exchange.

However, a man-in-the-middle attack can be lunched against this type of key agreement protocol. In this attack Mallory intercepts the message sent from Alice to Bob

and those sent from Bob to Alice. In both cases she pretends to be Bob when Alice sends a message to Bob, and pretends to be Alice when Bob sends a message to Alice. With Mallory in the middle of this key exchange, she can create her own two secret keys and exchange communications with Alice and Bob forwarding the messages so Alice and Bob are none the wiser. When Alice sends a message to Bob using what she thinks is the key Bob has, she really uses the one Mallory set up with her. The message is sent; Mallory intercepts it, decrypts it, reads or changes it, and then re-encrypts it with the key set up between Mallory and Bob. Bob receives a message he believes to be from Alice when it is really from Mallory. Now Mallory has full control over the communication channel and both confidentiality and integrity are lost because authentication was never established.

This key agreement protocol is still in use today; however, things have been changed to make it more secure and so that the man-in-the-middle attack cannot be used.

ElGamal is another common key exchange protocol that also relies on hard number theoretical math problems for its security. However, the property of authentication has never been addressed properly in the use of symmetric key encryption. There is still a level of doubt that you are communicating with who you say you are. To help alleviate this problem and provide authentication, asymmetric encryption was created.

Asymmetric Encryption (Two-Key Encryption)

Going back to the safe example, in asymmetric encryption two keys are needed instead of just one. One of the keys is used to open the safe for putting things into it, and the other is used to take things out of the safe (the analogy falls apart a bit here, but stick with us). Now with one key, key A, you can place data into the safe or encrypt it. After key A has been used to encrypt the data, only key B can open the safe to remove the data, or decrypt it. It is important to note that asymmetric encryption has the property that figuring out one key from the other should be as hard as decrypting the message without any key. Stated another way, the computational power required to decrypt an asymmetrically encrypted message is approximately the same as deducing one asymmetric key from the other. When these algorithms are applied to the sharing of keys for symmetric encryption, it becomes very clear how useful they are and why these properties are important.

Alice creates the two keys required for asymmetric encryption and publishes one of them to the world. Now everyone in the world, including Bob, has access to this key (Alice's public key). This means Bob or anyone else in the world, can encrypt data and send it to Alice for only Alice to read. Remember, the only person that can decrypt the cipher text is Alice, or the person with key B (Alice's private key, in this case). Now the problem of sharing a symmetric key is easy.

1. Bob creates a symmetric key.
2. He uses Alice's public key to encrypt the symmetric key so no one else can read it.
3. He sends the encrypted symmetric key to Alice.
4. Alice receives the encrypted symmetric key, decrypts it with her private key, and begins communicating with Bob using the symmetric key he created.

But why would I use the symmetric key encryption algorithms at all? If asymmetric algorithms are secure and I already have everyone's public key, why bother with creating a symmetric key and using symmetric algorithms? The answer to that question is simple—for speed. Using RSA, a standard asymmetric encryption algorithm on an average computer, you can encrypt 35,633 1024-bit messages in 10 seconds. Whereas using AES, the standard for symmetric encryption in CBC mode, you can encrypt 69,893 1024-bit messages in only 3 seconds. That is over 6.5 times faster using symmetric encryption instead of asymmetric encryption. Assuming both algorithms are secure, why would you use one that is 6.5 times slower than the other? Why is asymmetric encryption so slow? Asymmetric encryption uses properties of number theory to derive its strength. The addition and multiplication of these very large (1024-bit) numbers takes a very long time on computers compared to the binary operations performed in symmetric key encryption. Unfortunately, all of the asymmetric encryption algorithms today rely on number theoretic principals and require the use of very large numbers.

Even though asymmetric encryption is very slow, it does a very good job of solving the problem of sharing keys. Most symmetric algorithms have a key size somewhere around 128 to 256 bits. These keys can be encrypted in a single asymmetric message block, for most algorithms. This means only one message (the encrypted symmetric key) needs to be sent from Alice to Bob using an asymmetric algorithm before they can communicate using a symmetric algorithm. However, while asymmetric encryption does a good job of solving the key distribution problem, it has a few problems of its own besides slower speed.

Using a Certificate Authority

The first problem with asymmetric cryptography is in publishing one of the two keys. How does Bob know that what he thinks is Alice's public key is really hers? Why couldn't this be our old friend Mallory launching another man-in-the-middle attack by changing the publication of Alice's public key to her own public key? The answer to this is that Bob does not know that it really is Alice's public key that is published. To solve this problem we can enlist the help of our friend Trent. Trent can start a company to keep people's public keys. His company is called a *Certificate Authority* (CA). The idea behind a CA is that Trent's public keys are so well known, and distributed, that everyone believes them to be correct. This is where cryptography and money meet. It is money and company integrity that keep

Trent from turning into a Mallory. If everyone believes that Trent is doing his job properly, he builds trust. However, if Trent were to cheat the system even once and get caught, all credit for him and his company is lost and people will go elsewhere.

So how do you register your public key with Trent, and why does everyone believe they really know his public key? CAs contact software developers and negotiate to have them hard-code the CA's public key into every piece of software they develop. With this public key in a lot of different software and published on the authority's site, anyone can check to make sure that they have the correct key. Now anyone who wants to use this system has to believe that this public key is correct. With this trusted third party, Trent, anyone who wants can create a public key and register it with the CA. To do this you must create a certificate that includes, among other things, an expiration data, your name, and your public key.

Note

The X509 standard documents exactly what is in a certificate and how to create one.

When Alice needs Bob's public key she goes to the CA Bob has registered with and asks for Bob's public key. This public key is then encrypted with Trent's private key and sent to Alice. Alice can decrypt this message from Trent because she knows Trent's public key (public and private keys are not connected to encrypting and decrypting in any way. They are just labeled public if it has been published and private if it has not). Now, for the first time, you have authentication. Alice knows for certain that Trent has sent her Bob's public key because only Trent could create a message that will decrypt with his public key. This is what is called a *digital signature*, and it provides the missing goal of authentication.

Using a web of trust

While CAs work very well, they are expensive for the average user and are not the only method for sharing public keys. Another method for sharing public keys uses what is called a *web of trust*. A web of trust is when two people who trust each other, such as Alice and Bob, get together and share their public keys with each other. They have no reason to lie about their public keys, and in a face-to-face environment you know you are getting the public key from who they say they are through the use of a driver's license or some other form of identification. Now that these two people trust each other, they can go and find friends. Let's say that Alice finds Cathy, and Cathy wants to get into this web of trust so that she can send messages to Bob. Alice can verify Cathy's public key, sign it, and send it on to Bob. Now Bob is able to trust Cathy's public key because he trusts Alice. This web can extend to include any number of people at any level of security. If Cathy finds another friend and wants to give that key to Bob, he can work through the web of trust and end at Alice who he implicitly trusts. The depth of trust can be set by the user's paranoia level, but in theory, if everyone is checking everyone's identification and key, it should be a secure system. A very popular piece of software called Pretty

Good Privacy (PGP) implements this web of trust. There are also key servers that are set up so that after a key has been signed by someone it can be placed on the server so that Bob does not need to receive the message from Cathy directly; he can download Alice's signed version of Cathy's public key from the key server.

Before moving on to digital signatures, the following steps outline the RSA encryption algorithm. While it does not discuss the number theory behind the reason for this algorithm working, it is important to see how it works from a high-level point of view.

The following steps outline RSA key generation:

1. Generate two RSA primes, p & q , and compute $n = pq$ and $\Phi = (p - 1)(q - 1)$.
2. Select a random integer e from the interval $(1, \Phi)$ such that $\text{gcd}(e, \Phi) = 1$.
3. Select an integer d from the interval $(1, \Phi)$ such that $ed = 1 \pmod{\Phi}$.
4. The public key is (n, e) and the private key is (n, d) .

The following steps outline RSA encryption:

1. Let m be the message represented as a number in the interval $[0, n-1]$.
2. Compute $c = m^e \pmod{n}$ where c is the cipher text.

You can decrypt RSA with the following: Compute $m = c^d \pmod{n}$ where m is the original message.

Digital signatures

The process of encrypting a message with a private key so that anyone can read it, but knowing that it only came from the holder of the private key, is called *digitally signing*. The name refers to the fact that only the person who holds the private key can create cipher text that can be decrypted using the public key. The same idea is true with a real signature and a credit card, for example. In theory, only someone who can produce your signature is allowed to buy things with your credit card. With digital signatures it is true that if only your public key can decrypt a message, assuming you have not given away your private key to anyone, only you had the ability to create the cipher text in the first place. In reality, using digital signatures to purchase things with your credit card can be more secure than a real signature and your credit card. Digital signatures are founded on provable principals of mathematics, whereas, a real signature is only secure if no one can forge it.

Using asymmetric encryption is really, really slow; does this mean digital signatures are really slow as well? The answer depends upon implementation. Imagine that Alice has an e-mail that she would like to send to Bob. Alice wants to be able to

prove that the message came from her and not Mallory. Alice could create a symmetric key, encrypt the entire message with that key, then send the symmetric key encrypted with her private key to Bob along with the message encrypted with the symmetric key. This process would work because only that symmetric key would decrypt the message, and Bob would know it must have come from Alice because only she could have created it using her private key. However, what if Alice does not care who reads the message, and only wants to provide authentication for those who might not trust it is truly coming from Alice? To alleviate this problem, the message is represented as a smaller message and that is signed by Alice and sent along with the unencrypted original message. This smaller message is so small that it takes only a tiny amount of time to sign. Now anyone can read Alice's message and can also verify that it truly came from her and no one else. You go about making this smaller message that represents the larger one with a *hash function*.

Hash functions

Hash functions, also called *one-way* or *collision-resistant one-way functions*, are the fourth cryptographic primitive. A hash function takes a message of any size and computes a smaller, fixed-size message called a digest or hash (we will use digest to not confuse hash functions with what they produce). The computation required to compute a digest is very, very small. For example, remember that with AES in a CBC chain 69,893 1024-bit messages could be encrypted in 3 seconds. In that same 3 seconds, SHA-1, the standard for hashing, can hash 224,800 1024-bit messages. SHA-1 can compute digests 3.2 times faster than AES can encrypt those messages. Simply reading a file off of the hard disk requires approximately as much time as computing the hash while doing it. The way in which these hash functions compute a digest from an arbitrarily large message is beyond the scope of this book; however, there are three properties of all hash functions that make them very valuable.

- ♦ It is computationally infeasible to find two messages that can hash to the same digest.
- ♦ Given a digest, it is computationally infeasible to find a second message that will create the same digest.
- ♦ Given a digest, it is computationally infeasible to find the original message that created this digest.

These properties not only make hash functions very useful in the application of digital signatures, but also in storing passwords. Because the original message cannot be discovered from a digest, when storing a password only, the digest needs to be stored. This way, anyone can read the file containing the passwords, but no one can use this information to figure out someone's passwords.

While this is a very valuable cryptographic tool to have, there are some caveats to using hash functions, especially for password storage. First a message always

hashes to the same digest no matter how many times you compute it. The only way to change what digest is created is by changing the message. This property allows the proof of message integrity. If Mallory changes a message while it's in transit, the message's digest will be changed, as well. To protect message integrity, Alice must only compute her message's digest, and send that encrypted with Bob's public key to Bob along with the message. When Bob receives the message he can compute the digest the same way Alice did, and verify that the message has not been altered in any way.

Going back to password storage with a hash function, users do not like passwords and have trouble remembering good ones, such as xSok32\$IK329@)O. So instead, they create passwords such as *fluffy*, their cat's name. Mallory, who is looking to attack this type of password scheme, can compute the digest of all the words in a dictionary and compare those digests to the one stored in the password file. If one of the digests from the dictionary matches one in the password file, Mallory has discovered the password. However, one simple way of preventing this is to randomly *salt* the password before it is hashed. Salting is the addition of random data to a message before it is hashed so that the aforementioned dictionary attack cannot be carried out. The random data that is added is not too random, though, or no one would be able to verify the password. Instead the random data is chosen from one of only a few thousand possibilities. This randomly selected piece of data is concatenated to the password and then hashed. To verify the user's password, all combinations of the password and the random piece of data must be computed. If one of them matches, you can verify the password is correct. If none of them match, this password is not correct. This might seem like a lot of work, however, because hashing algorithms is a fast computation, computing a few extra thousand digests for a single password is not a big deal. However, computing a few extra thousand digests for all the words in the dictionary quickly becomes infeasible. As computers grow faster, the number of different saltings used are increased.

Bringing the discussion of cryptographic primitives full circle, hashing algorithms can be a great source of pseudorandom data. A method for creating pseudorandom data is outlined here:

1. Seed a hash function with a short random message. The resulting digest will be pseudorandom and the first number generated.
2. Using this number and a combination of the original seed create a new message. (The original seed and the digest must be used together because the digest alone is too small to compute a digest from. Remember the message is larger than the digest.)
3. This new digest is another pseudorandom number. This process is continued for as long as needed.

Like any pseudorandom function, the hashing algorithm will eventually cycle. However, the number of hashes needed to cause the algorithm to cycle is considered

computationally infeasible. This same basic method can be used to create a stream cipher. Simply use the key as your seed message. Then use the output of the hash function XORed with the plain text to create the cipher text. This is exactly like a one-time pad, but using a hash function as the random number generator.

Keyed hash functions

While most hash functions do not require any sort of key to create their digest, there are hash functions designed to require a key. The idea behind these functions is that they hold all of the same principles as that of a regular hash function except they also have the additional property that the digest cannot be created without the proper key. Being able to create a message key combination that hashes to the same digest should be computationally equivalent to enumerating through all the keys. Any regular hash function can be turned into a keyed hash function and vice versa, so the distinction for our purposes is negligent. However, it is important to know that such functions exist.

Putting These Primitives Together to Achieve CIA

Through the use of these four primitives, confidentiality, integrity, and authentication can be achieved. Consider the four scenarios where Alice is sending a message to Bob. She requires confidentiality in the first scenario, message integrity in the second, message authentication in the third, and all three in the fourth scenario. For all four scenarios assume that Alice and Bob have traded public keys and that they trust these public keys. This is a fair assumption to make because this is feasible through a web of trust or a certificate authority. It is important to note that while these scenarios demonstrate the ability to ensure these properties, they are not the only way to ensure them.

- ♦ **Confidentiality** — Alice wants to send a message to Bob without anyone else being able to read it.
 1. Alice creates a symmetric key and encrypts it using Bob's public key.
 2. Alice sends the encrypted symmetric key to Bob.
 3. Alice encrypts her message using the symmetric key and a symmetric key algorithm, and sends the message to Bob.
 4. Bob, and only Bob, is able to read the message because he has the symmetric key that was sent encrypted with his public key. Confidentiality is ensured.

- ♦ **Integrity**— Alice wants to send a message to Bob and ensure the message was not changed during transmission.
 1. Alice hashes her message and encrypts the resulting digest with Bob's public key.
 2. Alice sends the message and the encrypted digest to Bob.
 3. Bob is able to verify that the message has not been altered because he too can compute the message's digest and verify it with the one sent with the message.
 4. Mallory cannot change the message because the computed digest would not match the sent one. Mallory cannot change the sent digest because it is encrypted with Bob's public key. Integrity is ensured.
- ♦ **Authentication**— Alice wants to send a message to Bob and prove to Bob that she was the sender.
 1. Alice hashes her message and digitally signs the digest using her private key.
 2. She sends the message and the signed digest to Bob.
 3. Bob can verify the signature because he has Alice's public key. He can also verify that the digest belongs to that message because he can compute the digest.
 4. The only person that could create such a signed digest is Alice because only Alice has her private key. Authentication is ensured.
- ♦ **CIA**— Alice wants to send a message to Bob and in the process make sure that no one else can read the message, the message does not change, and prove to Bob that she was the sender of this message.
 1. Alice creates a symmetric key and encrypts the key with Bob's public key.
 2. Alice sends the encrypted symmetric key to Bob.
 3. Alice computes a digest of the message and digitally signs it.
 4. Alice encrypts her message and the message's signed digest using the symmetric key and sends the entire thing to Bob.
 5. Bob is able to receive the symmetric key from Alice because only he has the private key to decrypt the encryption.
 6. Bob, and only Bob, can decrypt the symmetrically encrypted message and signed digest because he has the symmetric key (confidentiality).
 7. He is able to verify that the message has not been altered because he can compute the digest (integrity).
 8. Bob is also able to prove to himself that Alice was the sender because only she can sign the digest so that it is verified with her public key (authentication).

While the last protocol seems a bit extreme, it ensures confidentiality, integrity, and authentication. This is part of the reason why speed is so important in cryptography. Sometimes, even to send the shortest message, multiple encryptions, hashing, signing, verifying, and decryption must be performed. This is why the fastest algorithm should be used when appropriate. Multiple protocols will ensure any combination of the three CIA properties. Each protocol has its advantages and disadvantages. The protocol used to complete a task is sometimes more important than the primitive used. Always make sure standards are followed when implementing any primitive or protocol.

The Difference Between Algorithm and Implementation

Most of the time, when you hear about a cryptography system being broken, it is an implementation of the system rather than the actual algorithm itself. The distinction between an algorithm and an implementation of that algorithm is an important one. For example, there is a Windows SSH client that had a vulnerability with one of the functions that was used in the RSA encryption. No check was made to ensure the base of the exponentiation was not as large as the modulus used. What that means exactly is not important. However, you should note that it was a particular implementation of the RSA algorithm that had a problem. This does not mean that RSA itself is in any way flawed. An algorithm can be 100 percent provably secure, like a one-time pad, for example. The algorithm used to generate the random numbers could be 100 percent secure, as well. However, if the implementation of that random number generator happens to publish the initial seed used, the entire system can be easily attacked. Again, this does not mean that the algorithm is flawed, but it does mean that this particular implementation of the algorithm is not secure.

How does an implementation of an algorithm become insecure? The answer usually rests with the person or persons who implemented the algorithm not understanding what it really does. For example, if you were charged with creating an RSA implementation, would you know what numbers must be kept secret and which ones can be published? Also would you know enough about the operating system you are implementing the RSA algorithm for to know that if numbers are stored in certain parts of memory they can be read by other processes running on the same computer? When it comes to implementing an algorithm, it really requires someone with extensive knowledge of the operating system on which the algorithm is being implemented. It also requires an in-depth knowledge of the algorithm being implemented. Another good RSA example is a theorem called the *Chinese Remainder Theorem* that can be used to speed up the exponentiation required for each encryption and decryption. However, this theorem requires that you keep the p and q in the RSA algorithm. Do these values need to be kept secure, or can they just be stored in raw form in a file? This is the kind of knowledge required to properly

implement an algorithm. If you do not have this level of knowledge about cryptography, using someone else's already tested implementation is usually the best idea.

A perfect example of a poor implementation of an algorithm is an FTP server that was recently published with an embarrassing vulnerability. This FTP server and client worked together to provide a secure means for transferring files to and from the server. This product was billed as a secure and seamless method for transferring files. To ensure that no one could capture the files and read them while being transferred from computer to computer, the traffic was encrypted. The encryption algorithm they used was DES, the standard for encryption at the time. Using DES, a published standard, instead of trying to invent an encryption algorithm was a sound idea. The implementation of the algorithm was perfect, as well; they just followed the standard. However, they ran into the same chicken-and-egg problem discussed with symmetric encryption; how do you distribute the keys? They knew that just using the same key was a bad idea, so they had the client create a new key for each session; but they still did not have a way to let the server know what the key was. So, instead of using asymmetric encryption methods, the key was simply sent as the first 56 bits of the data from the client to the server. After those 56 bits, all of the data sent from server to client or vice-versa was encrypted using DES. With a quick look at the DES standard, and some analysis of the bits sent across the network, a savvy hacker would quickly realize that DES uses a 56-bit key for encryption. From there, defeating the encryption was easy; anyone who was looking at the traffic already had the key. I'm willing to bet the software designers, though, that no one would be able to figure out the first 56 bits of data sent was the key used for the encryption. This leads right into the next subject, the use of open source algorithms and implementations versus proprietary ones. While this FTP server/client encryption mistake might seem like the exception, the use of proprietary algorithms and implementations with errors occurs more than most people think.

Proprietary Versus Open Source Algorithms

For most cryptography algorithms it is impossible to prove that they are secure. Some algorithms are founded in mathematics, such as the number theoretical ones shown earlier, and these foundations can help to ensure a level of security. However, even hard problems in mathematics are broken every once in a while. The only true test of an algorithm is time. The best algorithms are those that have been published for the entire world to see and have stood the test of time. If an algorithm has been published for a while, such as DES, AES, RSA, SHA-1, and so on, and still no one has been able to break the algorithm in any practical manor, the algorithm is assumed secure.

That said, there are still too many instances of companies creating proprietary encryption algorithms for use in their software. Most companies take the view that

these algorithms are like any other type of intellectual property; keeping it secret is the only way to do business. This attitude is completely wrong. Keeping an encryption algorithm secret can only do harm to the business if someday down the road someone is able to break the algorithm. Whereas, if the algorithm is published and allowed to be analyzed for a few years, that algorithm gains a reputation as being secure and becomes accepted in the community.

One perfect example of proprietary encryption being implemented is in DVDs. When DVDs were created they were to be the next generation in delivering movies to home theaters. DVDs have better quality sound and picture. However, Hollywood also wanted to be able to protect their movies from people copying them like VHS tapes. To aid in protecting them they enlisted the help of a company to create an encryption algorithm for encrypting DVDs. The idea was simple; they would encrypt the movies on the DVD and then have the players simply decrypt the movies as they were being played. The key used to encrypt the movie is stored in an encrypted form on the DVD. The player would simply use its key to decrypt the movie's key, and then start decrypting the DVD.

The problem with this whole scheme was that the algorithm used to encrypt the movie was flawed. The algorithm was created privately and was never published. Only the people who worked on the algorithm were able to test it. After DVDs had been out for a short time people started looking at the method of encryption. Just like the government looking at the codes from Enigma, the encryption was soon broken. This cost Hollywood and the DVD player manufacturers millions of dollars. What was to be a secure system to prevent people from copying movies was completely broken. DVDs could be played on open source computers without keys, and the movies could be copied. The entire system was rendered useless because they thought creating a new encryption algorithm was the best approach to security. This is never the case. In cryptography, maybe more so than in other areas of security, security through obscurity does not work.

Summary

While a lot of information is conveyed in this chapter, you should take note of a few important points.

- ♦ There are four main cryptographic primitives that are used to create all the cryptographic protocols used today. Each primitive has a specific use and, when combined, they can be very powerful.
- ♦ Using a key more than once on the same piece of plain text is very dangerous. No matter what the encryption algorithm, reusing a key can severely weaken the strength of the algorithm.

- ♦ Implementations and algorithms are two different things. While an algorithm can be completely secure, an implementation can be flawed for reasons that have nothing to do with security.
- ♦ Open source and standardized algorithms are always better than proprietary algorithms. Always stick to the standards and try, whenever possible, to use already tested implementations of the published algorithms.



Covert Communication

S*teganography* derives from the Greek word *steganos* (meaning covered or secret) and *graphy* (writing or drawing). On the simplest level steganography is hidden writing, whether it consists of invisible ink on paper or copyright information hidden within an audio file.

Today, steganography, stego for short, is most often associated with the high-tech variety, where data is hidden within other data in an electronic file. For example, a Word document might be hidden inside of an image file. This is done by replacing the least important or most redundant bits of data in the original file—bits that the human eye or ear hardly miss—with hidden data bits.

Where *cryptography* scrambles a message into a code to obscure its meaning, steganography hides the message entirely. These two secret communication technologies can be used separately or together, for example, by first encrypting a message, then hiding it in another file for transmission.

As the world becomes more anxious about the use of any secret communication and regulations are created by governments to limit cryptography and the use of encryption, steganography's role is gaining prominence.

Where Hidden Data Hides

Unlike a word-processed file where you're likely to notice letters missing here and there, it's possible to alter graphic and sound files slightly without losing their overall viability for the viewer. With audio, you can use bits of the file that contain sound not audible by the human ear. With graphic images, you can remove redundant bits of color from the image and still produce a picture that looks intact to the human eye, and is difficult to discern from the original.

15

CHAPTER



In This Chapter

Introducing steganography

Where did steganography come from?

How steganography relates to network security

Comparing steganography and cryptography

Types of Steganography



Stego hides its data in those tiny bits. A stego program uses an algorithm to embed data in an image or sound file and a password scheme to allow you to retrieve the information. Some of these programs include both encryption and steganography tools for extra security if the hidden information is discovered.

The higher the image or sound quality, the more redundant data there will be, which is why 16-bit sound and 24-bit images are popular hiding spots. If a person snooping on you doesn't have the original image or sound file to compare, he will usually not be able to tell that what you transmit isn't a straightforward sound or image file, and that data is hiding within it.

To emphasize the power of steganography, examine the two images shown in Figures 15-1 and 15-2.

Before you continue reading, try to decide which one of the images has a nine-page document embedded within it. Before you spend too much time with this, I will let you in on a little secret: just by looking at the image you cannot visually tell the difference between the two files. Just to put your mind at ease, it is the second figure that has data embedded within the image. Any differences you think you might see between the files have everything to do with how the images have been reproduced in the book. Trust me; you cannot visually find a difference between the two files.



Figure 15-1: A picture of a landscape



Figure 15-2: Another picture of the same landscape

Where Did It Come From?

One of the earliest examples of steganography involved a Greek fellow named Histiaeus. As a prisoner of a rival king, he needed a way to get a secret message to his own army. His solution? Shave the head of a willing slave and tattoo his message onto the bald head. When the slave's hair grew back, off he went to deliver the hidden writing in person.

Techniques such as writing between the lines of a document with invisible ink created from juice or milk, which show only when heated, were used as far back as ancient Rome. In 1499, Trithemius published *Steganographia*, one of the first books about steganography. In World War II Germany used microdots to hide great amounts of data on printed documents, masquerading as dots of punctuation.

Today steganography has come into its own on the Internet. Used for transmitting data as well as for hiding trademarks in images and music (called *digital watermarking*), electronic steganography may ironically be one of the last bastions of information privacy in our world today.

Where Is It Going?

Today software programs used for hiding data are available for free across the Internet. In fact, over one hundred different programs are available for various operating systems with easy point-and-click interfaces that allow anybody to hide data in a variety of file formats. In addition, several commercial stego software packages are available. A recent shift from freeware to commercial software products shows that there is indeed a market for this technology—and one that's willing to pay to use it.

Steganography has traditionally been used by the military and criminal classes. One trend that is intriguing today is the increase in use of steganography by the commercial sector. In the past when I talked about steganography at conferences, attendees came largely from research organizations, government entities, or universities. In the last year the tide has turned; now the biggest interest is definitely from the business sector.

Overview of Steganography

Steganography is the technique of hiding a secret message within publicly available data. Steganography means covered writing and emphasizes the fact that you are hiding or covering up what you are trying to communicate.

With steganography, someone has a secret or covert message that he or she wants to send to someone else. However, the sender does not want anyone but the intended recipient to know about the information, so she or he hides the secret message within a host file. The host file, or overt message, is the file that anyone can see. It is publicly available data that is used to hide a message.

For example, suppose Alice needs to send Bob a message about their boss. However, she knows that IT monitors and reads e-mail and if other people found out about this information it could have a detrimental impact to their organization. Alice and Bob are both big football fans and love the Redskins. Monday morning they are always sending each other pictures of the game. Because it is Monday morning, Alice downloads a picture of the game and uses a third-party program to hide her message in the picture and she sends it to Bob. In this example the message about their boss is the secret or covert message. The picture of the football game is the overt message. Anyone reading or intercepting the e-mail can see that Alice is sending Bob a picture of the football game; however, they have no idea that a secret message is hidden within it.

Steganography hides a party's true intent for communicating. For example, two parties might be exchanging pictures of classic cars, when in reality they are passing their plans to take over a company, hidden within the images of the cars. In this

case, the images of the classic cars are the host files and the secret messages are their plans to take over the company. The real reason they are communicating is covered up by the fact that both parties are interested in classic cars. The key is that the two parties must have a reason for communicating. If neither party were interested in classic cars, this would draw suspicion to why they are communicating and sending these images back and forth. Based on this fact, someone might figure out that there is a hidden agenda and look more closely at the images.

With steganography two parties still need to exchange information. It's just that the open information that is being communicated is not the real message. If the hiding technique is done properly, no one should be able to detect the secret message. It is important to point out that if someone is intercepting traffic, they can still tell that two people are communicating; they just are not aware of the real reason. It should be noted that if frequency rates of the open exchange either change drastically or correlate closely with other events, this could also tip someone off to the true meaning of the communications. For example, two parties normally exchange two e-mails per week, but during one week they exchange 20 e-mails, and the next week there is a national incident. If this pattern continues, someone could start to tie the two parties together and infer what they are doing.

Just as with encryption, with steganography two parties must agree on the algorithm they are going to use and exchange this algorithm prior to communicating. A simple example of a noncomputer-based steganography algorithm is to have a piece of cardboard that has certain squares cut out. By placing the cardboard template over a text message, the characters of the message that remain will reveal the secret message.

For example, the message being transmitted might be the following:

Low-risk applications can usually achieve adequate protection with typical commercial software and a reasonable amount of care in setting it up. These applications can be kept in a safe if necessary.

Placing the cardboard cutout over the paragraph reveals the letters in bold, which when put together say, "we will attack."

Low risk applications can usually achieve adequate protection **with** typical commercial **software** and a reasonable amount of care in setting it up. These applications can be **kept** in a safe if necessary.

Why do we need steganography?

Everything is created because of a perceived need, and there is definitely a need for steganography. Particularly in the last year, interest in steganography has exploded. The Deja News search engine allows someone to query the Internet's large number

of newsgroups for specific key words. Newsgroup postings related to steganography started at less than 10 per month in early 1995, were over 40 per month in late 1996, over 100 per month in 1998, and are well over a thousand today. This trend is even more pronounced on the World Wide Web. In 1995, a search using steganography as a keyword produced less than a dozen responses. In 1996, the same query produced around 500 hits. In 1998, it produced well over 1,000 hits.

Today, the results are close to 10,000 hits. Granted, not all of the hits are valid or relate directly to stego, but it definitely shows that there is a trend and an increased public interest in the topic.

Depending on the type of work someone does, normal businesses would not necessarily have an obvious need for steganography. Most companies don't care whether someone knows if they are sending proprietary information, they just want to make sure that it's secure. However, in certain cases, where a company is planning a secret takeover, or in cases where two engineers are working on a new high-tech system, steganography might be very helpful.

Steganography becomes important in the military for wartime activities. Drug dealers and other criminals doing questionable things could also use steganography to hide their dealings. So steganography could be seen as a negative tool; however, one could argue that many technologies that bring a benefit to society can also be used in a negative or criminal way.

Note

There are several foreign countries where the use of crypto is illegal. Also, with all the debate occurring over export controls on encryption, steganography is a good way to disguise the type of data that is being sent. If no one can tell what data is being sent, it doesn't matter how many keys it's encrypted with.

Pros of steganography

Stego is a very powerful tool if it enables two people to be tied together by a communication path.

For example, if someone is working for the CIA and is a spy for the Russians, the mere fact that this person is communicating with the Russian Embassy on a regular basis is extremely suspicious regardless of what type of information is being passed. In this case, direct communication between the two parties is prohibited. In this case, the spy could post his message to one of numerous newsgroups, bulletin boards, or FTP sites that are present across the Internet. However, because he is a spy he would not want to post this sensitive information directly, so he would use stego. He would hide his message within an innocent-looking file and post that to a set location. His counterpart at the Russian Embassy would go to that site and pull down the message, extract the hidden message, and read it. This concept is often

called a *digital dead drop*. The idea of a digital dead drop plays off of how a traditional dead drop works. Dead drops are used in cases where two parties cannot explicitly meet. Instead, they arrange a time and a place where one party would drop off a message or package and the other party would pick it up. For example, if I needed to exchange a short message with you, I could tell you a particular restaurant and table you should eat at around 1:00. I would go and eat at that same table before you and tape a message to the bottom of the table. No one else would be able to see it, but when you came to eat you would quietly reach under the table and remove the message taped underneath the table.

The key advantage to stego is the ability to communicate without anyone knowing the true intent of your communication. In situations where parties cannot even be seen communicating, combining stego with digital dead drops, provides an elegant solution.

Cons of steganography

Recall the concept of defense in depth; to have a high level of security, you must deploy multiple levels of security. No security layer or technology is going to make you secure. Stego is no exception; it has lots of benefits, but it is not perfect. The first negative aspect of stego is that even though the message is hidden, if someone knows it is there, they can read it. This problem can easily be solved by remembering defense in depth and applying cryptography to the message before you hide it. This way, even if someone can find the message, the person cannot read it. This is further discussed later in this chapter.

Another problem with stego is if someone thinks you are using stego, the person could easily destroy any hidden message. In most cases, when you hide data within an image you would insert your message into the least-significant bits. An easy way to destroy this information is to convert it to another format and either leave it in that format or convert it back to the original format. For example, if you have a JPEG image and you convert it to TIFF and then back to JPEG, even though the image looks exactly the same to the human eye, the actual bit composition of the image is different. If the bit composition changes even slightly, your message is destroyed. This is usually not an issue unless someone is highly suspicious of what you are doing, and even if they are, such a technique is very time consuming to accomplish.

Comparison to other technologies

When talking about stego, some people wonder how it is different from other technologies such as Trojan horses, covert channels, and Easter eggs. This section compares these technologies with steganography.

Trojan horses

Attackers often use Trojan horse programs to sneak viruses or other types of malicious code into an organization without anyone noticing. To do this, a Trojan horse has an overt and a covert program. The overt program is what the user sees, such as a game or some animation, and the covert program is what is installed in the background without the user noticing it. The covert program is usually the virus or some malicious back door program that the attacker wants installed on a given system.

Trojan horse programs are similar to traditional stego in that there is an overt and a covert feature and the program runs in such a way that the true intent of the program is hidden from the user. The user or anyone seeing the traffic thinks that he or she is getting a game or some other file and the person runs the program. As the program runs, good things are happening in the foreground or on the screen and bad things are happening in the background.

Trojan horse programs are slightly different than traditional steganography in that with stego, one party manually puts the secret message into a file and the other party has to manually extract it. There is no way to have the content automatically run when it gets to the recipient. Stego uses the overt file just as a place to put a payload, but the payload is passive and will not take any adverse action on a remote system. A Trojan horse's main goal is to maliciously run a program without the user noticing and without the user's permission. In this sense, Trojan horses are a specialized subset of stego because they can only be hidden in executable files and will always actively do something against the destination host.

Another big difference between Trojan horse programs and stego is the intent of the communication. With stego, there has to be two parties involved, the sender and the receiver. Both of these parties are aware of the scheme and are using stego to bypass some third-party observer. With Trojan horse programs, only one person, the attacker or the sender of the malicious code, is aware of what is happening. The recipient has no idea what is happening and is unaware of the true intent of the communication.

Covert channels

Covert channels are actually very similar to stego and are considered a subclass of stego. With covert channels, two parties use resources that are available to them to signal information without anyone else knowing they are communicating. Covert channels have the benefit that any third party is not even aware that the parties are communicating.

For example, here is a noncomputer-based scenario employing covert channels. John and Mary are very successful bank robbers. One of the things that make them so successful is that they use many ways to communicate so they are harder to trace. They had lengthy discussions about robbing Acme Bank. John needed to go to the bank in the morning and make sure that the security had not changed. Based

on what he found, he would decide whether they were going to rob the bank or not. He told Mary to walk by his apartment at 10:00 a.m. If there were a fern in the corner window, the robbery would be on; if no fern were visible in the window, the robbery would be off. Placing the fern in the window is the covert channel. Bob placing the fern in the window would not look the least bit suspicious, because he does that on a regular basis to give the plant more light during the day. However, covert channels are not perfect because other people could interfere with the communication without even knowing it. Perhaps John decides that the robbery is too dangerous and calls it off. He signals this to Mary by not putting the plant in the window. However, while John is out, his roommate decides it is a nice day and puts the plant in the window. Now Mary thinks the robbery is on and John thinks it is off.

Now examine a computer-based example and you will see that the same types of issues arise.

Bill and Sally work for the same company and have been secretly meeting for lunch to discuss their plans to start up a competing firm. They know that if they are seen leaving together it would raise suspicion. They also know that the company monitors all communication and encrypted messages are not allowed. Because they both work for the same company, they both have access to the same file server. On the file server are several folders including one called *Research*. Each research project has a code name. Everyone in the company can see all of the folders; they just cannot access them. Bill and Sally come up with a plan that if a project folder called *Alpha1* appears on the file server under research, they need to meet today. If Bill decides he needs to meet with Sally he will create a folder, and when Sally checks the file server she will see the folder and meet up with Bob.

Covert channels are similar to stego in that both parties know they are communicating. The big difference is that there is no open communication as there is with stego. Using the Bill and Sally example, they could have sent a file to each other with a message hidden within the file, but this would have linked the two parties together in terms of the open communication. With covert channels, there was no link at all between the two parties because as far as anyone could tell no open communication was taking place. It was all being communicated covertly.

Easter eggs

Easter eggs are a hybrid of Trojan horses and stego. An Easter egg is a hidden feature that the developers of an operating system or application sneak into the program and, at some latter point in time, release to the public. Easter eggs are usually fun programs that the developers insert. Typical Easter eggs are videos or little games that are inserted into the code. Over 6,000 different Easter eggs for a variety of operating system and application can be found at www.eeggs.com. Easter eggs operate very similarly to stego in that someone inserts the covert data into the overt program and someone has to follow a specific set of steps to remove it. The intent is not malicious, as with Trojan horses, and these programs do not automatically run without the user's consent.

History of Steganography

Stego is not a new field. As long as there have been people on the planet there has been a need for certain people to communicate without others knowing what they are saying (cryptography). There has also been a need to communicate without anyone even knowing you are trying to communicate (steganography). A very good book that covers the history of cryptography and to some extent steganography is called *The Code Breakers* by David Kahn.

Using steganography in the fight for the Roman Empire

Julius Caesar built the Roman Empire, and there were people who supported him and people who didn't. Caesar had to find a balance between making sure his enemies did not find out his secrets and trying to find out his enemy's secrets (a trend that is evident throughout history). Cryptography was important to make sure no one could read what Caesar was communicating to his allies, but the mere fact that he was communicating could have tipped his hand. Caesar's enemies had the same dilemma, and that's where stego came into play.

In the days of ancient Rome, they realized the value of recording information and keeping notes and communicating them to other parties. Originally, they used pieces of wood and they would carve symbols into the wood with a sharp object. The problem with this approach was that it was not reusable, because there was no easy way to erase what was carved into the wood. To solve this problem they began melting an inch or two of wax onto the piece of wood. Then they could carve the symbols into the wax, and when they wanted to erase the message, they applied heat to the wax via an open flame to melt it back down to a smooth surface. This provided an easy way to reuse the board.

When there was a sense that people were planning to overthrow the Roman Empire, Julius Caesar became very concerned and wanted to find out who was planning the attack and intercept their plans. He had his guards stop people on the roadways and examine any messages they were carrying to try to figure out his enemies' plan. His enemies quickly realized this and knew that if a guard found a message on his or her message board that Rome did not like, it meant instant death. To overcome this, Julius Caesar's enemies decided to use steganography. They removed all of the wax from the wooden board and carved their message into the board. They then melted an inch or two of wax onto the board leaving the wax blank and covering up the message that was carved into the wood. Then when the guards stopped them, the guards only found a blank board with nothing carved into the wax and let them go. Upon arriving at their destination, they would melt off all of the wax and reveal their hidden message.

In this example, the board with an inch or two of wax and nothing carved into the wax is the overt message that anyone could see, including the guard. The message carved into the wood is the secret message that is concealed by the overt message, the wax. The guards knew that the people they stopped had a blank message; they just had no idea of the true intent of the communication.

The other important point to remember is that this scheme was a little dangerous. If the guards suspected a hidden message and melted away the wax, the protection would be gone and the message could be read.

Steganography during war

During World Wars I and II and most other wars, steganography played a major role. One aspect of war is about deception and misleading the enemy, and what better way to deceive the enemy than to hide the true intent of what you are doing?

Hiding within ships

One technique often used is to hide bombs and other military supplies on commercial ships to transport them to their destination. There would be less of a chance that someone would attack a commercial ship than a military vessel. This is one of the reasons that the Germans targeted commercial ships during World War II and tried to sink them with their submarines; they knew the ships contained supplies for the war effort.

Using steganography in conjunction with the environment

Using steganography to hide something within an innocuous-looking object happens all of the time. This is the real essence behind camouflage, so tanks, guns, and military personal can hide within an environment and no one can tell they are there. I once saw a picture of a dense forest with lots of trees and bushes. Then someone pointed out to me that, with camouflage, an entire platoon of soldiers and tanks was hidden within the woods.

Another common tactic is for military personnel to dress in civilian clothes so that they blend in with the locals. Especially in hostile situations, if you look and act like a local person, you have a far better chance of survival than if you are dressed up in full army gear. A great example of this was in the beginning of the movie *Black Hawk Down* (based on true events), where a man is dressed in the local clothes and riding a bicycle. As the scene progresses, you realize that he is a U.S. military agent in disguise and he is there to gather intelligence. He then rides his bike to the far end of town where a military helicopter picks him up and takes him back to base.

This concept is used not just by the military but also by many arms of law enforcement. It is what the concept of undercover agent is built on.

Core Areas of Network Security and Their Relation to Steganography

Whenever you look at a new security technology, it is helpful to see how it maps to the core areas of network security. No single technology is going to directly map against all three of the core areas, and that is why you should always use a defense-in-depth strategy in protecting your assets. One needs to achieve a variety of goals when performing secret and covert communication.

**Note**

There are some additional goals or sub-goals that certain new technologies (such as ways to do e-commerce without submitting a credit card and additional forms of authentication) bring to the table that are outside the scope of the core areas of network security. These are discussed at the end of this section.

Confidentiality

Confidentiality deals with keeping your secrets secret and making sure any unauthorized person cannot access or read your information. Confidentiality is at the heart of what steganography does. Steganography, however, accomplishes it in a slightly different manner than cryptography does. With cryptography, an unauthorized person can see the information; they just can't access it. However, because they can tell that there is information being protected, they can try to break the encryption. With steganography, because the data is hidden, unauthorized parties don't even know there is sensitive data there. From a confidentiality standpoint, steganography keeps the information protected at a higher level than other security methods. Look at the following example.

John has been working on an investigation at his company because someone has been stealing their sensitive information and selling it to a competitor. He is starting to get nervous that the people involved have domain administrator access and therefore can read anything on his local system or private share on the network server. If they can read his reports and evidence, they can destroy the information or take action that would make the investigation very difficult to perform. Because John has a law enforcement background and is super technical he decides that he needs to use some form of steganography to hide this information. He has a friend, Mary, in accounting who he knows can be trusted. He decides to go into all of her spreadsheets that she uses for accounting purposes and to scroll way down to the bottom of the spreadsheet. He inserts hundreds of blank cells and then copies his sensitive data at the bottom of the spreadsheet. Now if someone opens the spreadsheet they would see the normal spreadsheet and even if they scrolled down a ways they'll just see blank cells and think it is the bottom of the spreadsheet. This is not a terribly sophisticated method, but if someone does not know the link between John and Mary, they probably won't suspect where the data is hidden and the data is protected from a confidentiality standpoint.

Integrity

Integrity deals with making sure that unauthorized parties cannot modify information. Steganography does not directly deal with the integrity problem, but it indirectly deals with integrity because if someone cannot find the information they cannot modify it. However, once they find the hidden information there is nothing stopping someone from modifying the data.

Availability

Availability deals with preventing the unauthorized denial of access to information. Steganography does not address the availability problem. If data is hidden within a group of files and someone tries to delete all of the open files, there is nothing built into steganography that will stop someone from doing this.

Additional goals of steganography

Steganography deals with hiding information and making sure an unauthorized party cannot find it. Therefore, some additional goals need to be achieved for steganography to be effective.

Each technology has different additional goals that it tries to achieve (for cryptography, the goals are different). Steganography does not address nonrepudiation at all. However, even though it is not a main goal, steganography can be used to achieve a low level of authentication. Authentication deals with validating who a given entity is. One way to do this is to hide information within a file or within a file system. Now a person or a program can be authenticated by the recipient by seeing if the hidden data exists. If it exists the person is authenticated; if the hidden data does not exist the person is denied access. This technique has little validation because once someone finds out where the data is being hidden it can easily be spoofed.

Survivability

The main goal of communicating is one party sending information so that the other party can receive it. Even when data is being hidden within a message, you have to make sure that whatever processing of the data takes place between sender and receiver does not destroy the information. You want to make sure that the recipient cannot only receive the information but can extract it so they can read the message. When dealing with steganography, it is critical to understand the processing of a message will go through and determine whether the hidden message has a high chance of survivability across a network, if that is the means of communication.

An example of low message survivability follows. Phil wants to communicate with Mary so he creates 20 postcards with numbers written on them. The message is

encoded based on the order in which the postcards are sent. Phil puts the postcards in the correct order to reveal the message he wants to communicate. He goes to the post office and every hour he mails out a postcard. From Phil's perspective the post cards were mailed in the correct order to reveal his secret message to Mary. However, what are the chances that these postcards will arrive in the same order they were sent? Very low. Therefore, even though this technique uses steganography, it has a very low survivability and should not be used to communicate hidden messages.

This technique can be adjusted to increase the survivability. What if Bob mails out one postcard a day? This increases the survivability a little but it is still not great. What if he mails out a postcard once a week? Now he is getting to a more acceptable level of survivability; and if Bob sends out one postcard a month he has a very high survivability rate, however, the practicality of this method is very low. Sending one postcard a month could take years to get the message across to Mary. Even though there are things that can be done to increase survivability, you have to make sure that the end result of doing this still makes the method practical.

No detection

If someone can easily detect where you hid your information and find your message, it defeats the purpose of using steganography. Therefore, the algorithm used must be robust enough that even if someone knows how the technique works they cannot easily find out that you have hidden data within a given file.

Visibility

This goal is similar to the no detection goal in that if you are hiding data not only do you not want someone to be able to detect it, but you want to make sure someone cannot visibly see any changes to the host file that is being used. If I hide a secret message within an image and it distorts the image in such a way that someone can tell it has been modified, that is not a good steganography technique. For example, if I take a Word document that contains one page of text and is 200 KB in size and I hide my data within the file and now the size of the file is 20 MB, someone can visibly tell that there is something very unusual about that file.

Principles of Steganography

Steganography is concerned with being able to hide as much data as possible in an overt message and doing it in such a way that it is difficult for an adversary to detect and difficult for an adversary to remove. Based on these aims, there are three core principles that are used to measure the effectiveness of a given steganography technique:

- ♦ **Amount of data** — Steganography is all about hiding as much information within a file as possible. In most situations, the more data you can hide, the better off the technique.
- ♦ **Ease of detection** — Whenever you hide information, you want to make sure it is very difficult for someone to detect. There is usually a direct relationship between how much data can be hidden and how easy it is for someone to detect. As you increase the amount of information hidden within a file, you increase the chances that someone will be able to detect that information within the file.
- ♦ **Ease of removal** — In some situations, even if someone cannot detect whether data is hidden within a file, they can still try to remove any data. What essentially is happening is someone is saying, “I have no clue if data is hidden within the file or not, but if it is I am going to make sure it is removed.” For example, suppose a stego technique is used to hide data within BMP files. If I then convert the BMP file to a JPEG file format and back to the BMP format, the hidden information will have been removed. If a company was concerned about employees sending out BMP images that have data hidden within them, they could create a little program, which, whenever e-mail is sent or received containing a BMP attachment, will convert the BMP to JPEG and back to BMP and forward the message to the recipient. The recipient then receives the same file except that any hidden information would have been removed.

Steganography Compared to Cryptography

As previously touched on, the difference between cryptography and steganography is with cryptography, anyone looking at the message can tell that it's an encoded message, they just can't read it, and steganography hides the fact that someone is sending secret information.

Protecting your ring example

The following is a nontechnical example of the difference between the two. If someone has a diamond ring that they want to protect, one option could be to lock it up in a safe. This is equivalent to using cryptography. If anyone comes in the house, they can see the safe and know that they have valuables, but they can't access the ring. The second option is to hide the ring behind a book on a bookshelf. This is equivalent to steganography. The fact that someone has a ring is being hidden, but if someone figures out where it is hidden, they will have access to the ring. The last option is to put the ring in a safe that's in the wall that's covered up with a picture. This is equivalent to using both steganography and cryptography. The picture is hiding the fact that there's a safe (steganography) and the safe is keeping the ring secure (encryption).

Putting all of the pieces together

Because both cryptography and steganography compliment each other, it is usually recommended that both be used in coordination with each other. After a secret message is written, it would first be encrypted, then hidden in a host file. This way it provides two levels of protection. Even if someone can break the steganography, they still cannot read the message because it's encrypted. They would have to take the next step and try to break the encryption.

Note that by using an encrypted message as the secret message, it makes the message more secure, but it can also make the steganography technique more detectable. It is fairly easy to determine whether a given segment of text is encrypted or not by plotting a histogram (a graph that depicts how often each character appears). Figure 15-3 shows a plot of nonencrypted ASCII text and Figure 15-4 shows a plot of encrypted ASCII text. In these graphs, the y axis is frequency and the x axis is the ASCII value for each character. The nonencrypted text has values of zero except at 10, which is line feed, 13, which is carriage return, 32, which is a space, and 97 to 122, which is a to z. The encrypted text, however, is equally distributed across all ranges and has a fairly flat distribution. It is also interesting to point out that for nonencrypted text, the highest frequency is around 200 and for encrypted text, no character occurs more than 14 times. This shows that the encryption flattens out the distribution.

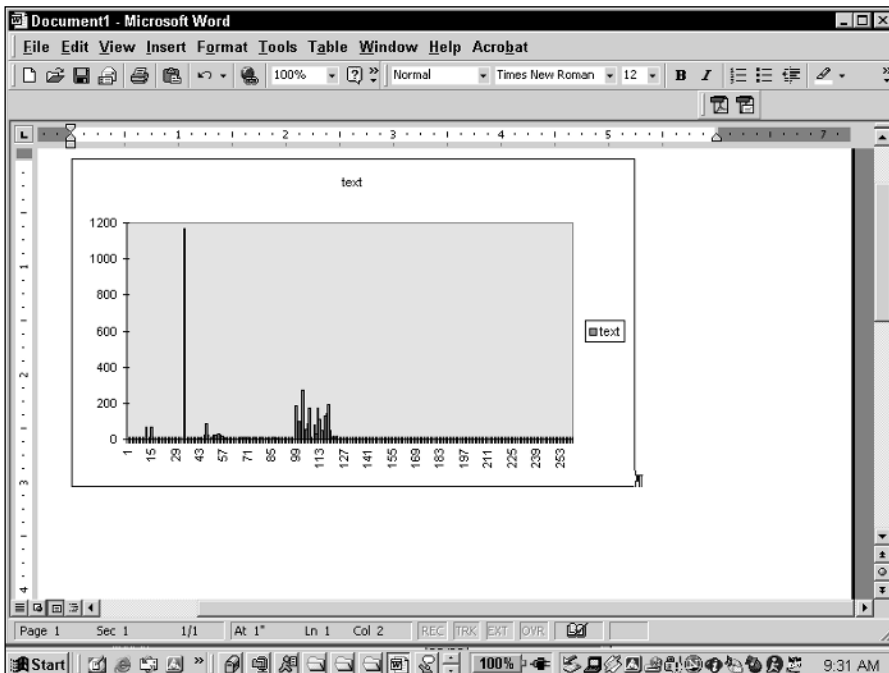

Figure 15-3: Nonencrypted ASCII text

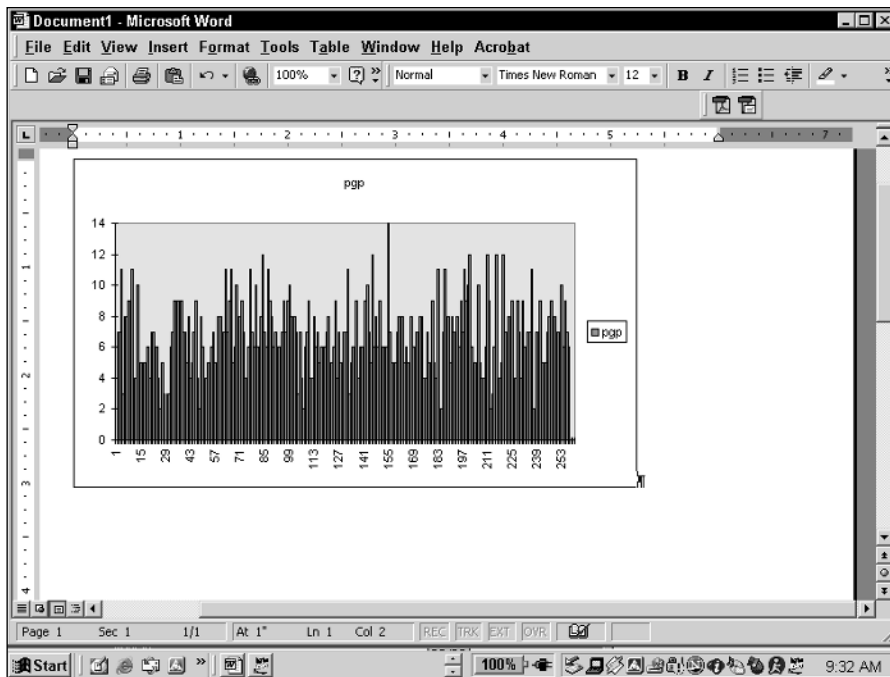

Figure 15-4: Encrypted ASCII text

If someone has an idea of where the data might be hidden in the host file, they can run a histogram on this data and, depending on the results, have a good idea whether encrypted data is hidden within the file. The data would still be secure, but the extra layer of protection that one gets by using steganography would be lost.

Steganography is similar to cryptography in that once people figure out how to break current steganography techniques, new techniques need to be developed. As with cryptography, a cycle develops, where one side keeps devising new techniques and the other side keeps figuring out new ways to break it. The thing to remember is that with cryptography the goal of cracking it is to be able to read the message. With steganography the goal of cracking it is to determine that there is a hidden message within the overt file.

Types of Steganography

Over the years, people have categorized steganography techniques in different ways. These are meant only as general categories because if someone is creative the options are limited only by one's imagination. Throughout my career in stego,

I have used two different schemes. I would first describe the old scheme and then the new scheme. I switched taxonomies because I feel the new way is more comprehensive and general, and better addresses some of the new tools that have come out in recent years. However, both methods work and that is why I describe them both here.

Original classification scheme

Originally, I used a classification that broke steganography down into the following three groups:

- ♦ Insertion-based steganography
- ♦ Algorithmic-based steganography
- ♦ Grammar-based steganography

This scheme really focuses on how the data is hidden and covers the main techniques.

Insertion-based steganography

Insertion-based steganography techniques work by inserting blocks of data into the host file. With this type of technique, data is inserted into a file at the same point for every file. This category of technique works by finding places in a file that can be changed, without having a significant effect (if any) on the resulting file. Once this is identified, the secret data can be broken up and inserted in these areas and be fairly hard to detect. Depending on the file format, this data can be hidden between headers, color tables, image data, or various other fields. A very common way to hide data is to insert it into the least significant bits (LSB) of an 8-bit or 16-bit file. An example is hiding data in 16-bit sound files. With sound files, one can change the first and second LSB of each 16-bit group without having a large impact on the quality of the resulting sound. Because data is always being inserted at the same point for each file, this can be referred to as an insertion steganography technique.

Algorithmic-based steganography

Algorithmic-based steganography techniques use some sort of computer algorithm to determine where in the file data should be hidden. Because this type of technique doesn't always insert data into the same spot in each file, this could possibly degrade the quality of the file. If someone is going to have the file before data is hidden in it and afterwards, they might be able to see a change in the file. This class of techniques needs to be examined carefully to make sure it is not detectable. An example is hiding data in an image file. This type of technique requires a number to seed the steganographic technique. This number can be either a random number or the first 5 bytes of the file. The algorithmic technique takes the seed value and uses

it to determine where it should place the secret data throughout the file. The algorithm can be very complex or as simple as if the first digit is 1, insert the first bit at location x , if the first digit is 2, insert the first bit at location y , and so on. If careful thought is not given to the algorithm used, it can result in a disastrous output file.

Grammar-based steganography

Grammar-based steganography techniques require no host file to hide the secret message. Both of the other techniques require a host file and a secret message. Both the insertion and algorithmic techniques take the secret message and somehow embed it into a host file. The grammar-based technique requires no host file; it generates its own host file. This class of technique takes the secret message and uses it to generate an output file based on predefined grammar. The output file produced reads like the predefined grammar. Someone can then take this output file and run it through a program using the same predefined grammar to get the original secret message. For example, if someone wanted a piece of text to sound like the *Washington Post* Classified Section, one could feed in a large amount of source material from the classified section and gather statistical patterns that would make it possible to mimic its output. This could be used to hide data from automatic scanning programs that use statistical patterns to identify data. This is a program that scans data looking for anything unusual. For example, if someone is posting a classified ad, it would not be appropriate for it to be all binary or something that is not English. The program could scan for English-type text and if it fits the profile, it is allowed to pass. Using a grammar-based stego technique would look like English, so it would pass this filter.

New classification scheme

The previous scheme really focuses on how the data is hidden. The new scheme covers both how and where the data is hidden. The new scheme was developed because as new techniques have been developed over the last several years, some of these newer techniques did not map cleanly into the previous scheme. This new scheme is more comprehensive and is a better breakdown of modern data stego.

The new classification breaks down the techniques into the following categories:

- ♦ Insertion
- ♦ Substitution
- ♦ Generation

**Note**

It is important to realize that even though both classification schemes have a category of insertion, what insertion means is different between the two schemes.

Insertion

With insertion, places in a file are found that are ignored by the application that reads a file. Essentially, what you are doing is inserting data into a file that increases the size of a file but has no impact on the visual representation of the data. For example, with some files there is a flag called an end of file (EOF) marker. This signifies to the application reading the file that it has reached the end of the file and will stop processing the file. In this case, you could insert your hidden data after the EOF marker and the application will ignore it.

Another example of an insertion method would be with Microsoft Word. With Word there are markers within the file that tell Word what data it should display on the screen and what information should not be displayed. This becomes important with features such as undelete where information is still stored in the file but not displayed to the user. This can be demonstrated by going into Word and creating two documents. I will create one new document and type, "This is a test" into it. For the other document, I will start with a larger document and slowly delete the information until I am left with only the words "This is a test." If you look at both of these, shown in Figures 15-5 and 15-6, you will see they look exactly the same.

However, if you go in and look at the file sizes, you will notice that they are different. In Figure 15-7 you can see that the document that once had additional information in it is larger than the other document.



Figure 15-5: New Word document that contains the words "This is a test."



Figure 15-6: Existing word document that has been modified to contain only the words “This is a test.”

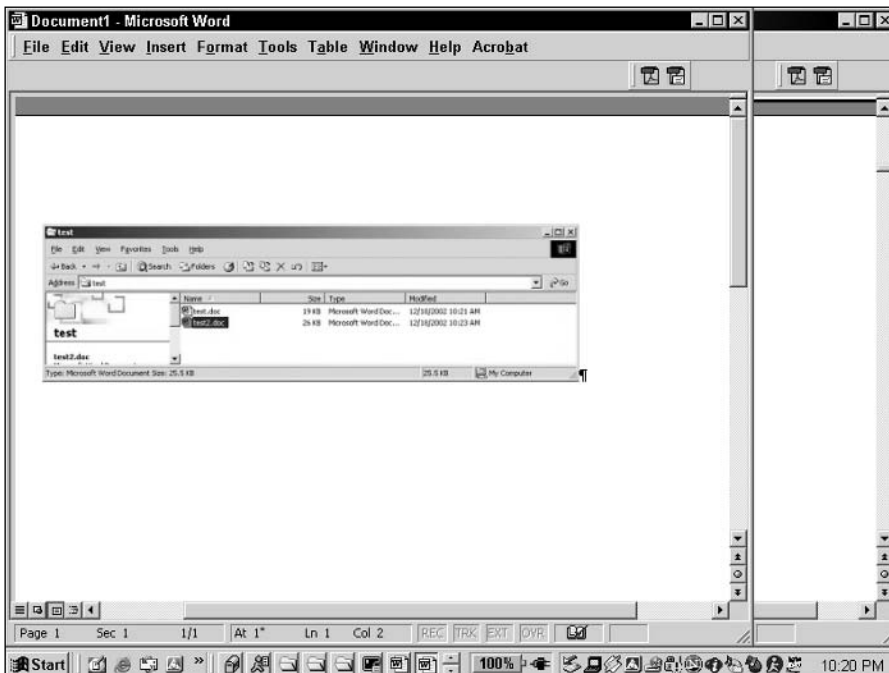

Figure 15-7: Examination of the file sizes for the two files that contain identical text

At a high level, the way word documents are configured is that they contain begin text and end text markers. Anything between a begin text and end text marker is processed, and anything between an end text marker and a following begin text marker is ignored. This can be seen in Figure 15-8. Anything between a begin text and end text marker, or what is in yellow, is displayed in the application. Anything that is between an end text and begin text marker, which is shown in red, is ignored.

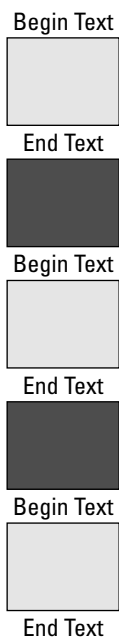

Figure 15-8: The high-level layout of how Word processes a file

Now you can go in and insert as much data in the red areas as you want and it will not impact the image.

The main attribute of insertion is that you are only adding data to the file; you are not modifying or changing any of the existing information that is already in the file. The good news is that with insertion you can theoretically hide as much information as you want with no image degradation. The bad news is at some point the file will be so large that it looks strange. For example, if you have a file that only contains “This is a test” and it is 5 MB in size, someone might question it.

Substitution

With substitution stego, you go in and substitute data within the file with your own information. Another word for substitution is overwrite. You overwrite data in the file with your own data. This might seem simple, but you have to be careful. If you go in and just overwrite any data, you could make the file unusable or make it visually

obvious that something was done to the file. The trick is to find insignificant information within a file. This is information that can be overwritten without having an impact on the file.

For example, take the Word example talked about in the previous section and make it a substitution technique instead of an insertion. In this case, any data in the red area has minimal impact on the end file and could be overwritten. This would have no impact on the visibility of the file but would still enable you to hide data.

With substitution there is a limit to how much data you can hide because if you hide too much you will run out of insignificant data to overwrite or start to overwrite significant data and impair the usability of the image. Using substitution does not change the size of the file.

Generation

In both insertion and substitution, you need both a covert file and an overt file in which the covert file is hidden. With generation there is only a covert file and that is used to create the overt file. The overt file is generated or created on the fly and does not exist at the beginning of the process. One of the problems with stego detection is if someone can obtain both the original file and the one with data hidden in it they can tell that they are different from a binary composition standpoint. In this case, because there is no original file, there is nothing to compare against. The most common example of generation stego is using your overt file to create a fractal image. A fractal image has critical mathematical properties but is essentially a collection of patterns and lines in different colors. You could use your covert message to determine the angle, the length, and color of each line.

A simpler example of a fractal would be to define a short line to equal a 0 and a long line to equal a 1. Also, an acute angle could equal a 0 and an obtuse angle would equal a 1. You could then take your binary covert file and use the bit pattern to create a simple fractal of different size lines with different angles.

With generation there is no overt file originally; it is created on the fly. The key to generation is that the image that is generated must fit within the profile of the person that is using it.

For example, with the other techniques, if I have an interest in antique cars there would be nothing unusual about the fact that someone was sending me pictures of classic cars. However, if all of a sudden I receive images of fractals, that might look very suspicious. But if I was into modern art or a mathematician with an interest in fractals, that message content would be fine. Remember, if the overt file draws a lot of attention, it defeats the purpose of using stego.

Color tables

To describe how data is hidden in image files, color tables must be briefly described, because this is where several of the techniques hide the data. All images are

composed of dots, called *pixels*. By putting all these pixels together, the image is formed. Each pixel has its own color, which is formed by having varying degrees of red, green, and blue (RGB). Each of these three colors has a value that can range from 0 to 255. Zero means the color is not active and 255 means a full amount of the color. Pixels with the following values make specific colors:

- ♦ 255 0 0 is red
- ♦ 0 255 0 is green
- ♦ 0 0 255 is blue
- ♦ 0 0 0 is black
- ♦ 255 255 255 is white

In the RGB color model there are a total of $256 \times 256 \times 256 = 16,777,216$ possible colors.

The RGB values for each pixel are stored in a color table. Each entry has a value for the row and a value for red, green, and blue. Each pixel has a color associated with it stored in the color table. The pixel contains a value that corresponds to the row in the color table that contains the RGB value for that pixel. Part of a color table is shown in Figure 15-9. The first number is the row number; this is the number the pixel references to get its corresponding color. The second number is the value for red. The third number is the value for green. The fourth number is the value for blue.

Begin Text
End Text
Begin Text
End Text
Begin Text
End Text
Begin Text
End Text

Figure 15-9: Part of a color table with annotation

Products That Implement Steganography

This section looks at several commercially available steganography programs and goes over how they work and how the data is actually hidden in the host file. The public domain tools covered include the following:

- ♦ S-Tools
- ♦ Hide and Seek
- ♦ Jsteg
- ♦ EZ-Stego
- ♦ Image Hide
- ♦ Digital Picture Envelope
- ♦ Camouflage
- ♦ Gif Shuffle
- ♦ Spam Mimic

Hundreds of stego tools are available, but this section is meant to highlight the unique aspects of the different techniques. This section provides a sample of insertion, substitution, and generation, showing the different ways it can be done and the different files that data can be hidden in. In most cases, the other tools that are available are similar to these tools in functionality and usability. Therefore, if you understand how these tools work, you should be able to use any of the available tools.

S-Tools

S-Tools is a freeware program that runs on most versions of Windows and has a drag and drop interface. It can hide data in gif image files, bmp image files, or wav sound files. It can also perform encryption with IDEA, DES, Triple DES, and MDC. Compressing the files is also an option. S-Tools also offers the ability to hide multiple secret messages in one host file. For all of the file formats, it hides data in the three least significant bits of the data bytes. It is important to note that most of the stego tools available give you the option to protect the data with a password, encrypt the data, or compress the data.

For images, S-Tools works by distributing the bits of the secret message across the least significant bits of the colors for the image. The method for hiding data in images depends on the type of image. The BMP format supports both 24- and 8-bit color, but the GIF format only supports 8-bit color. 24-bit images encode pixel data using three bytes per pixel: one byte for red, one byte for green, and one byte for blue. The secret message is then hidden directly in the three LSB of the pixel data. The disadvantage to 24-bit images is that they are not that common and they are very large. To reduce the file size, 8-bit images use a different system.

8-bit images use a color table or palette of 256 RGB values. This means the color table has 256 entries. The pixels are represented by a single byte, which specifies which RGB value from the color table to use. To be able to hide data, S-Tools modifies the image to use only 32 colors instead of 256. The color palette is changed to have these 32 colors. Because the color table can hold 256 entries, there is now extra space in the table. The 32 colors are duplicated 8 times ($32 \times 8 = 256$) to fill the color table with duplicate entries. S-Tools can then use the duplicate entries to store the secret message in the three LSB for each RGB entry. Because each color in the (modified) image can be represented in eight different ways, information can be conveyed by whichever one of the redundant representations was chosen. S-Tools often employs this method because most images are stored as 8-bit images because of their smaller size. This will also work with gray scale images because they are almost always 8-bit color and the color table contains 256 different shades of gray.

For sound files, the data is put directly into the three least significant bits of the raw data. This works with either 8-bit or 16-bit WAV files. The following example is taken from S-Tools that shows how this works. It shows a sample sound file with the following data hidden within the file:

```
132      134      137      141      121      101      74      38
```

In binary, this is:

```
10000100 10000110 10001001 10001101 01111001 01100101
01001010 00100110
```

Suppose that you want to hide the binary byte 11010101 (213) inside this sequence. You simply replace the LSB of each sample byte with the corresponding bit from the byte you are trying to hide. So the preceding sequence will change to the following:

```
133      135      136      141      120      101      74      39
```

In binary, this is:

```
10000101 10000111 10001000 10001101 01111000 01100101
01001010 00100111"
```

Using S-Tools is very easy; you would just perform the following steps:

1. Double-click the icon to start up the program, which is shown in Figure 15-10.
2. Drag the image in which you want to hide data into the program.
 - a. Put the mouse over the image.
 - b. Click the left mouse key and keep it depressed.
 - c. Move the image into the programs screen, which can be seen in Figure 15-11.

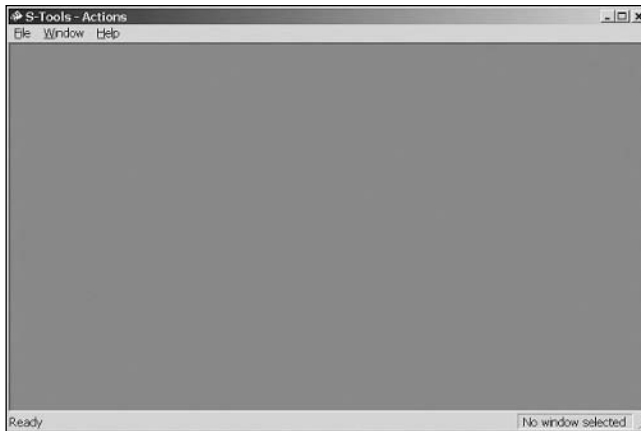

Figure 15-10: Opening screen for S-Tools



Figure 15-11: S-Tools with an image loaded

3. Drag the message you want to hide into the program.
 - a. Put the mouse over message.
 - b. Click the left mouse key and keep it depressed.
 - c. Move the image into the programs screen and on top of the image you previously dragged into the program.
4. When requested, type the pass phrase shown in Figure 15-12 and you are done.

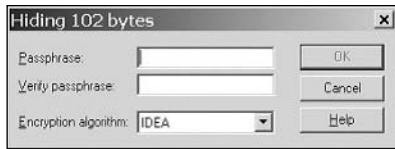

Figure 15-12: S-Tools prompting the user for a passphrase

Hide and Seek

Hide and Seek version 4.1 is freeware that runs under DOS and embeds data in GIF images using one least significant bit of each data byte to encode characters. It then uses dispersion to spread out the data (and thus the picture quality degradation) throughout the GIF image in a pseudo-random fashion. This method is fundamentally the same as the 8-bit method used by S-Tools. The only difference is that Hide and Seek only reduces the color table to 128 colors and has two duplicates. Hide and Seek only works with 8-bit color encoding.

Noise (which is slight variations made to the file by external interference) is noticeable for larger files, but the smaller ones look fairly good. When using Hide and Seek, the smaller the size of the image the better. The file to be hidden can't be longer than 19K because each character takes 8 pixels to hide, and there are 320×480 pixels in the maximum VGA display mode, thus $(320 \times 480)/8$, which equals 19,200. This gets rounded down to an even 19,000 for safe dispersion.

Hide and Seek actually consists of two executables, one for hiding and one for extracting the data. Both programs run from a command prompt and you pass in the arguments for the file names. When you run **hide** from a command line with no options it gives you the arguments you need to provide (see Figure 15-13).

```

C:\WINNT\System32\cmd.exe
C:\HIDEAN"1>hide
HIDE data hiding program v 4.1
hides data inside GIF files.

usage: hide <infile_ext> <giffile[.gif]> [key]
       where [key] is an optional locking code, up to 8 chars.

note: will always produce a new GIF called outfile.gif

C:\HIDEAN"1>

```

Figure 15-13: Output from running Hide with no command line options

In this case, you type **hide** followed by the covert file followed by the overt file—just a reminder that the covert message contains your hidden message and the

overt file is the open message. Because **hide** is relatively weak and easy to crack, you can also provide a key that will lock the message and make it harder to crack.

If I type the command shown in Figure 15-14, you can see the command sequence used.

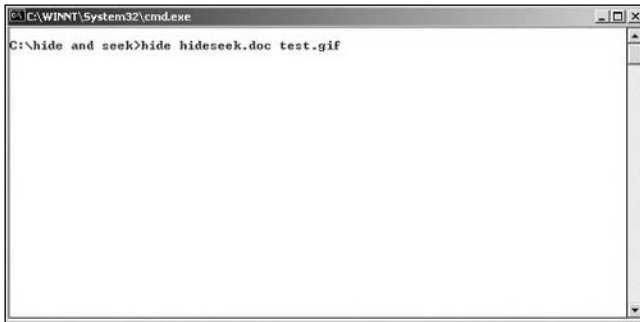

Figure 15-14: Process for hiding information using hide.

You are then prompted with the message shown in Figure 15-15.

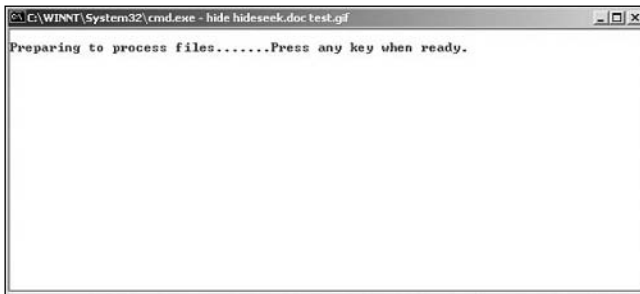

Figure 15-15: Prompt generated by hide during the stego process

You will then see the message image flash up on the screen as data is being hidden within it. When it is done, you receive the following message:

Done! Remember to delete your original file for safety, if necessary.

This reminder is based on the concept that if someone can get access to both the original clean file and the file with data hidden in it, they can compare the two files.

Jsteg

Jsteg hides data in JPEG images. This technique is quite different from all the other techniques. Jpeg uses a lossy compression algorithm to store image data, meaning compressing the data and restoring it may result in changes to the image. This is why JPEG images are used on the Internet; when compressed they take up less space. A lossy data compression or encoding algorithm is one that loses, or purposely throws away input data during the encoding process to gain a better compression ratio. This is compared to lossless where the algorithm does not lose or discard any input data during the encoding process. Therefore, if lossy compression is used, the messages stored in the image data would be corrupted. At first glance, it would seem that this file format could not be used to hide data. To overcome this, instead of storing messages in the image data, Jsteg uses the compression coefficients to store data. JPEG images use a Discrete Cosine Transform (DCT) compression scheme. Although the compressed data is stored as integers, the compression involves extensive floating point calculations, which are rounded at the end. When this rounding occurs, the program makes a choice to round up or round down. By modulating these choices, messages can be embedded in the DCT coefficients. Messages hidden in this way are quite difficult to detect.

Jsteg has a simple built-in wizard that you can use for hiding and extracting images. The first screen prompts you whether you want to hide or extract information. In this case, we will first hide data and then extract it afterwards. Figure 15-16 shows the initial screen for Jsteg.



Figure 15-16: Initial screen for Jsteg

Jsteg then prompts you for the file you want to hide, which can be seen in Figure 15-17.

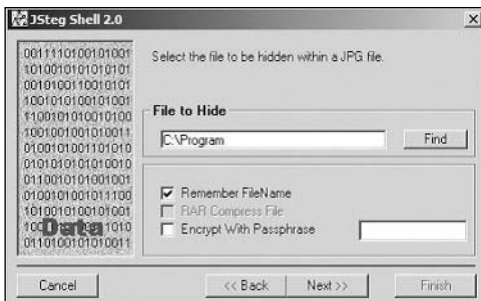

Figure 15-17: Jsteg screen to pick the covert file

You then select what overt file you want to use to hide the data, as shown in Figure 15-18.

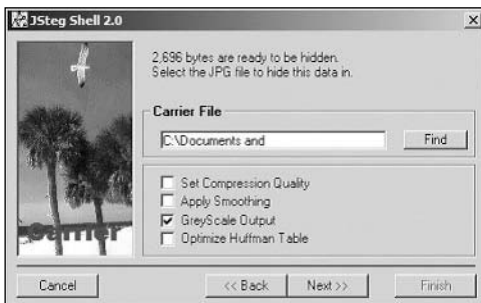

Figure 15-18: Jsteg screen for picking the over file you want to hide data within

You then have to select the name of the output file that will contain the hidden data, as shown in Figure 15-19.

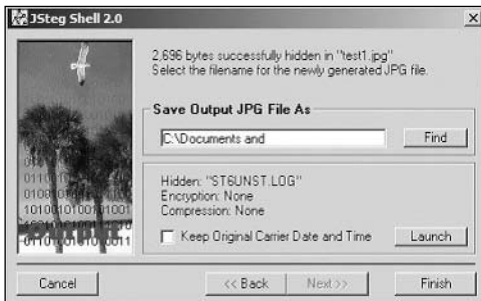

Figure 15-19: Jsteg screen for picking the name of the output file

Because Jsteg can use a gray scale, embedding the original image is shown in Figure 15-20 followed by the image that has data embedded in it in Figure 15-21.



Figure 15-20: Original image taken from a Windows computer system



Figure 15-21: The previous image converted to grayscale by Jsteg with data embedded within it

Now that you have data hidden in a file, you need a way to extract the information. Jsteg provides the same graphical user interface (GUI) as before, except now you select extract instead of hide, as shown in Figure 15-22.



Figure 15-22: Jsteg opening screen with the extract file option selected

The extraction process is simple in that all you have to do is select the file that has data hidden in it and Jsteg will automatically extract the information. This can be seen in Figure 15-23.

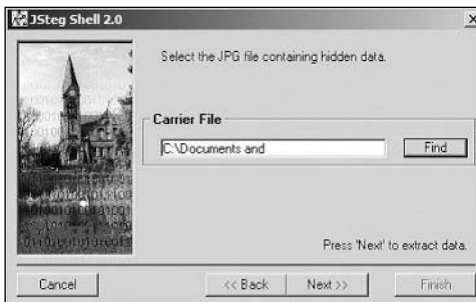

Figure 15-23: Jsteg prompting for the file that has data embedded within it

As you can see, Jsteg is probably one of the easiest stego programs to use. It takes little effort or understanding of the process to hide data and the technique is fairly robust.

EZ-Stego

EZ-Stego hides data in GIF images and is written in Java. EZ-Stego stores data in the least significant bits of GIF images. It does this by storing the data in the color table,

but the table is not modified in the same way as with S-Tools and Hide and Seek. The color table is manipulated by sorting the existing colors in the palette, rather than reducing the color in the image and making duplicate color entries. With this technique the color table is sorted by RGB colors so that similar colors appear next to each other in the color table. This is very crucial, so that the output image will not be badly degraded.

Ez-Stego copies the color table from the image and rearranges the copy so that colors that are in close proximity to each other in the color model are near each other in the color table. It then takes the first pixel and finds the corresponding entry in the newly sorted color table. It takes the first bit of data from the secret message and puts it in the least significant bit of the number corresponding to the row in the color table that the pixel points too. Then it finds the new color that the index points to and finds that color in the original color table. The pixel now points to that row corresponding to the new color in the color table. This is why having the color table sorted is crucial; when the pixel points to a new entry in the color table, the corresponding color is very close to the original color. If this assumption is not true, the new image will have degradation.

Image Hide

Image Hide is a stego program with an easy-to-use GUI and can hide data in a variety of formats. It does so in a similar fashion to the other techniques already discussed, by replacing the least significant bits of the individual pixels of an image. However, it does the embedding on the fly, which makes this program very unique. When you start the program, you get a generic-looking screen, shown in Figure 15-24.

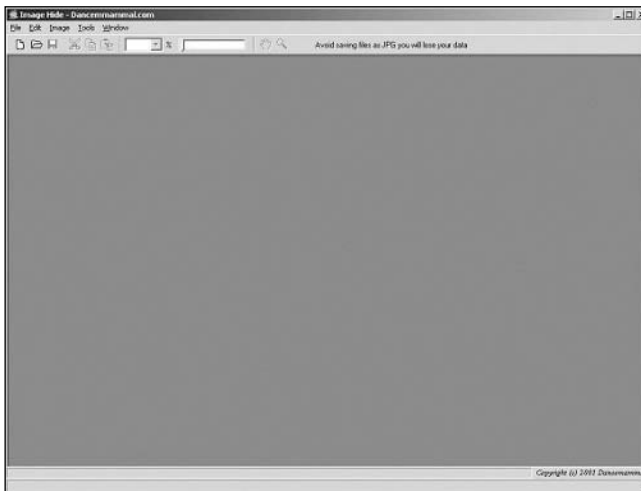

Figure 15-24: Opening screen for Image Hide

You then open the file in which you want to embed data. You highlight the area in which you want to hide data, type the message, and click the write button (see Figure 15-25).

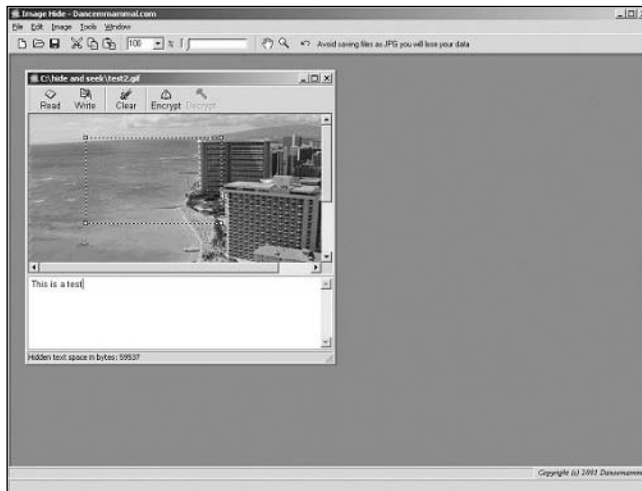

Figure 15-25: Opening screen for Image Hide with overt file loaded and covert message type at the bottom

At this point the data is hidden within the file and you receive the screen shown in Figure 15-26. You can either hide more data or extract the data you already hid.

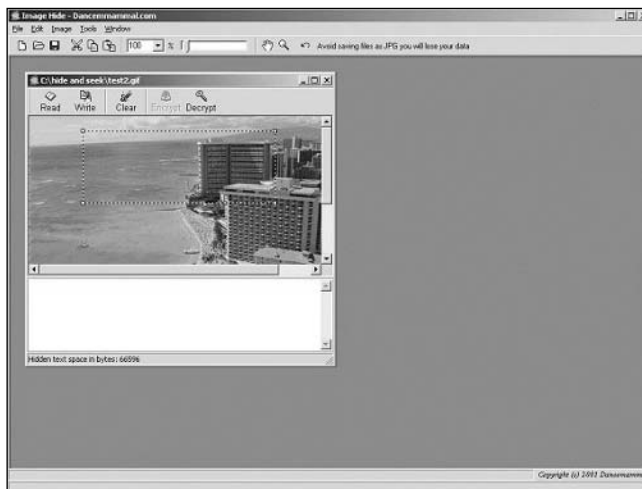

Figure 15-26: Image Hide with image loaded that contains embedded information

To extract the data that you already hid, highlight the area on the screen and click read, and your message will appear at the bottom of the screen, as shown in Figure 15-27.

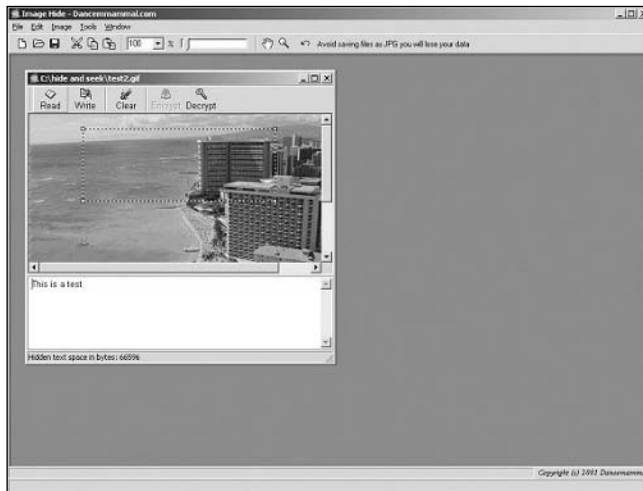

Figure 15-27: Image Hide with embedded message extracted and appearing at the bottom of the screen

Because Image Hide is an insertion technique, it does not increase the size of the file; however, that also means it has limits on the amount of data it can hide.

Digital Picture Envelope

Digital Picture Envelope (DPE) is a stego technique that hides information within a BMP file. What makes this technique unique is that it cannot only hide large amounts of data within an image, but it can do so without changing the file size. This program is based on a hiding technique called BCPS, which was invented by Eiji Kawaguchi in Japan. DPE can use normal 8-bit BMP images but, in most cases, to get the maximum amount of data hidden it uses true color or 24-bit BMP images. The data is embedded in the bit planes of the images, which allows the amount of data to be hidden to be very large. This technique is also called large-capacity stego.

The program comes with two programs, one for embedding the information and one for extracting it. It is important to note that for those of us that do not speak Japanese, some of the prompts and error messages are in Japanese, but there is enough in English that you can easily figure out what is going on. To hide data within an image, start up the encoder application, as shown in Figure 15-28.

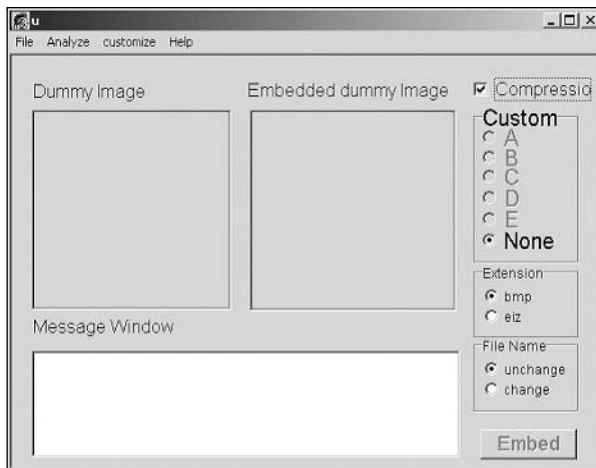

Figure 15-28: Digital Picture Envelope GUI for embedding information within a file

Drag and drop the image in which you want to hide information onto the dummy image area of the program. Then take the text you want to embed and copy it to the clipboard of windows and click the Embed button. When you click that button, the text being hidden will pop up in a window, as shown in Figure 15-29.

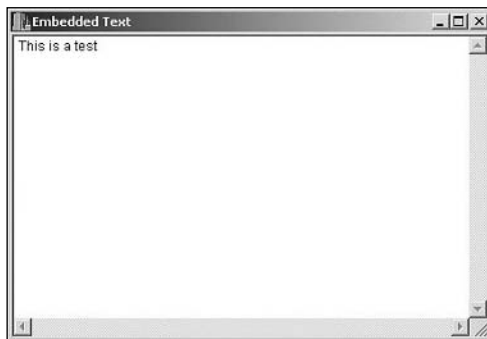

Figure 15-29: Digital Picture Envelope Screen showing covert message.

The program then shows both images, as shown in Figure 15-30.

You can now see both images and how similar they look. You can also see on the bottom window that if you click analyze, the program will analyze the dummy image and tell you how much data you can hide within it.

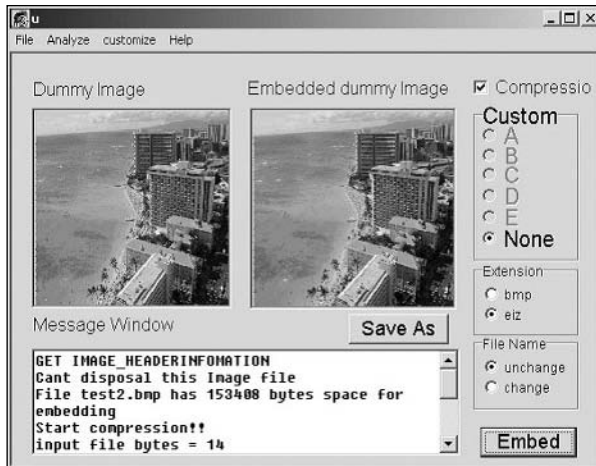

Figure 15-30: Digital Picture Envelope screen showing both the original image and the image that has data hidden within it

To extract the message you hid, you have to use a separate program. Start up the program, open up the picture that has data embedded within, and click the Extract button, as shown in Figure 15-31.



Figure 15-31: Digital Picture Envelope GUI for extracting information from a file

Camouflage

Camouflage is a relatively simple technique that works across a variety of formats. It is an insertion technique that hides data at the end of a file. Essentially, it puts the data after the end of the file marker so the application ignores this information.

Because it is an insertion technique, you can hide large amounts of data, but it is fairly easy to detect. What also makes this program unique is that you do not run a special application to hide and extract information. If you have a file that you want to hide, right-click the file, as shown in Figure 15-32.



Figure 15-32: Drop-down menu showing options for Camouflage

As part of the windows options, you now have two additional options, one to camouflage and one to uncamouflage. The first option hides data and the second option extracts the data. Once again, you can see the simplicity with using these applications.

Gif Shuffle

Gif Shuffle is a program that hides data within GIF images. It does this by manipulating the color map of the image. The order of the color map does not matter for GIF images, but in normal images they are not sorted. Gif Shuffle takes an image and sorts the color table by similar colors. This is done using the RGB values. These values actually consist of numbers that indicate the intensity of each color. Containing numbers allows them to be sorted. A mod operation (which is dividing one number by another and taking the remainder) is then performed and each piece of the covert message is hidden within the color map.

Gif Shuffle is a command line tool that you use to hide and extract the message. It also comes with a command-like option that will show you how much data can be hidden in the file. Because it manipulates the color map, there is a limit to the

amount of data that can be hidden. To see how much information can be hidden, you would use the S option (see Figure 15-33).

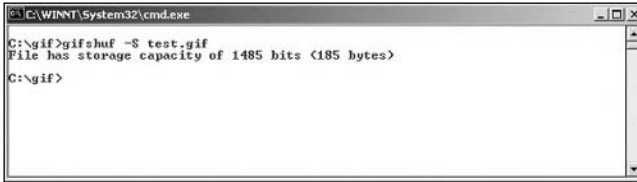

```
C:\WINNT\System32\cmd.exe
C:\gif>gifsuf -S test.gif
File has storage capacity of 1485 bits (185 bytes)
C:\gif>
```

Figure 15-33: Gif Shuffle showing how much data can be hidden within a file

Using Gif Shuffle you can either hide a covert file or you can pass text to the program that it will hide. Figure 15-34 shows the file *covert.txt* being hidden within a GIF image.



```
C:\WINNT\System32\cmd.exe
C:\gif>gifsuf -f covert.txt test.gif out1.gif
Message used approximately 12.99% of available space.
C:\gif>
```

Figure 15-34: Using Gif Shuffle to hide data

You can also use the p option to protect the information with a password or the C option to compress the data. To extract the message you would just type the name of the program followed by the file that has hidden data, and the message appears. The extraction process is shown in Figure 15-35.



```
C:\WINNT\System32\cmd.exe
C:\gif>gifsuf out1.gif
This is a test message
C:\gif>
```

Figure 15-35: Using Gif Shuffle to extract data

Spam Mimic

Spam Mimic is a generation technique that takes a covert message and generates text that looks like spam. It uses a rule set of English grammars that generates spam-like text. Essentially, it creates a grammar tree showing the different possible words that could be used, and, based on the covert message, decides which word to use. A simple example is the phrase “_____ went to the store.” The blank could be filled in by a number of different words, such as he, she, it, and so on. By building a grammar and using the covert message you can pick what words appear and generate the text. You can then use the technique in reverse to find the hidden message.

Spam Mimic is also different from the other techniques previously looked at in that it runs from a Web site. You go to www.spammimic.com and type your message, as shown in Figure 15-36.

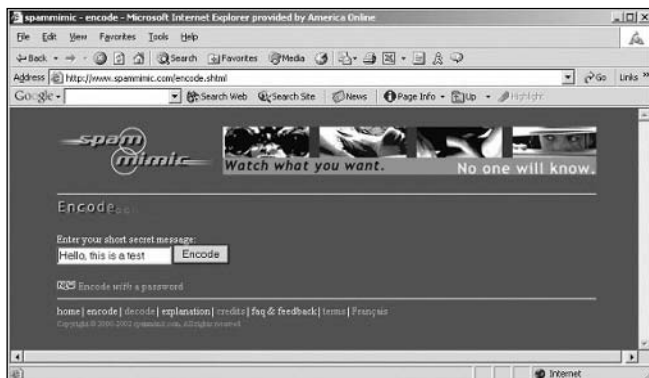

Figure 15-36: The Spam Mimic encoding screen

After you click the Encode button, the program generates the overt message, as seen in Figure 15-37.

As you can see, one of the limitations of this program is the small amount of text that you can type. Actually, you can type as much information in the box as you want and you can also cut and paste in long messages into the window to make it easier, but the developers purposely kept the box small to discourage people from typing long messages. When you type a long message, the output text starts to repeat itself and it looks unusual. The reason for this is that it uses a limited grammar. With a more advanced grammar or by changing the grammar, this could be avoided.

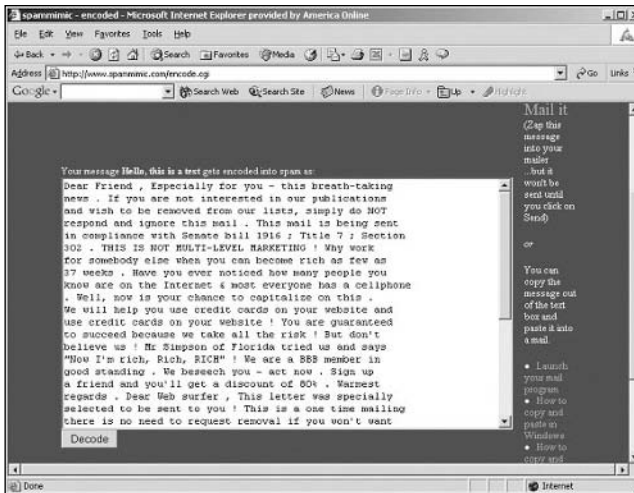

Figure 15-37: Spam Mimic's decoding screen

The other problem with this technique is that the ratio of input to output text is very large. For example, if I fed the preceding paragraph into the program as my covert message, the output message would be 12 pages in length. This is more of a proof of concept to show you the power of text generation techniques.

Steganography Versus Digital Watermarking

With the need to increase sales via the Internet, companies with Web content, such as *Playboy* magazine, are faced with an interesting dilemma. *Playboy* wants to be able to post pictures on the *Playboy* Web site to sell more magazines, but the company also wants to make sure that nobody steals the images and posts them on other Internet sites. Because browsers download images for you to view them on Web pages, *Playboy* can't stop people who view the site from downloading images.

By using digital watermarks *Playboy* and other online content providers can embed visible marks in their image files that flag them as their property. Digital watermarks are almost impossible to remove without seriously degrading an image, so this helps to protect their material from piracy. Of course, some sites might post a digitally watermarked image even though doing so is flagrantly illegal. That's why many companies who use watermarks also regularly scan sites looking for their unique signature in images. When they find these sites, they send their lawyers after the perpetrators.

What is digital watermarking?

According to dictionary.com, a watermark is, “A translucent design impressed on paper during manufacture and visible when the paper is held to the light.” If you have an important printed document, such as a title to an automobile, you want to make sure that someone can’t just print out a copy on a laser printer and pretend to own your car. A watermark on such a document validates its authenticity. You can see watermarks on everything from diplomas to paper money.

An electronic watermark is an imprint within a document file that you can use to prove authenticity and to minimize the chance of someone counterfeiting the file. Watermarking is used to hide a small amount of information within an image and to do it in a way that doesn’t obscure the original document.

Typically, a watermark is visible only to those who know to look for it. The trick with watermarking is to provide a subtle element that doesn’t overwrite anything else in the image that is significant enough to validate the image.

Why do we need digital watermarking?

Copy protection has always been a problem for businesses that deal in images or audio recordings. Now that so much content is stored in digital form and so many people have access to it through the Internet, protection of visual and audio material has become even more challenging. After all, if possession is nine-tenths of the law, how can you let someone view and copy a file but still prove that you are the owner?

This is where digital watermarking becomes critical. Digital watermarking provides a way of protecting the rights of the owner of a file. Even if people copy or make minor transformations to the material, the owner can still prove it is his or her file.

For example, companies that rent or sell stock photos to an advertising agency putting together a print advertisement use watermarking all the time. Each electronic stock image contains a digital watermark. An ad agency can preview the images, but not use them in a real advertisement until they buy the image and receive a copy with no watermark present.

Properties of digital watermarking

Digital watermarking hides data within a file and is, therefore, a form of steganography. However, it is a very limited form and is appropriate only for protecting and proving ownership, not for transmitting information.

Digital watermarking inserts a small amount of information throughout a file in such a way that the file can still be viewed. However, if the watermark were ever removed, the image would be destroyed.

When using digital watermarking, the goal is to find information within a file that can be modified without having a significant impact on the actual image. The important thing to remember is that when you apply a digital watermark to a file, you are modifying the file. Essentially, whenever you modify a file at the bit level you are introducing errors into the file. As long as the errors are low, the overall impact on the file will be minimal. Most files can tolerate minor changes, but some files have zero tolerance for errors. With zero tolerance for error files, a bit change, no matter how minor, causes the file to be unusable.

Adding anything to a file is referred to as adding *noise*. Most file structures are created so that they have a high tolerance to noise. That is why digital watermarking and steganography are effective against digital files.

The one category of files that has a low tolerance to noise or errors is compressed files. Compressed files have been put through a process that removes any redundancy, allowing the size of the file to be greatly reduced. Introducing any errors to a compressed file will render it unusable.

Types of Digital Watermarking

From an embedding standpoint, there are two general types of watermarks: invisible and visible.

Other categories for watermarks have been proposed. For example, one way some people differentiate digital watermarks is by the robustness of the watermark and how easy it is to remove. From our perspective, this is not a category of watermark; it is simply a rating scheme to determine the quality of the watermark. For our money, visible and invisible types of watermarks are the categories that are worth a closer look.

Invisible watermarking

With invisible watermarking you are applying a pattern to a file or an image in such a way that the human eye cannot detect it, but a computer program can. When you look at an image, what you are really seeing is a bunch of little dots of color (pixels) arranged in such a way that they create an image.

The resolution on a computer screen is measured in pixels, so if you change from 400×600 resolution to 1024×768 , the image on your screen will be of much better quality.

With most images, a pixel can be one of millions of colors. Actually, there are more colors than the human eye can interpret in graphics files. So, with an invisible watermark you can change certain pixels so that the human eye can't tell that anything is missing. However, a computer program can.

The other important thing to remember about an invisible digital watermark is that the smaller the pixels, the less chance there is that someone will be able to discern changes to them.

Visible watermarking

Like an invisible watermark, a visible watermark makes slight modifications to an image such that the image can still be seen, yet a watermark image appears within it. One of the advantages of visible watermarks is that even if an image is printed out and scanned, the watermark is still visible.

A visible watermark image will usually make use of a light grayscale tone, or simply make the pixels that contain the watermark slightly lighter or darker than the surrounding area.

The trick is to make sure that the watermark is applied to enough of the image so it cannot be removed. One challenge with visible watermarks is to make sure the original image is still visible. If you apply too much of a watermark, all you will see is the watermark and little of the actual image.

Complex mathematical formulas can be used to make watermarks more robust, but at a general level, a watermarking program finds a group of pixels and adjusts the pixels in a way that the watermark can be seen but the image is not destroyed. The usual way of performing this operation is to make the color of specific pixels darker.

Goals of Digital Watermarking

Before comparing digital watermarking with other forms of steganography, it is important that you have in mind the goals of digital watermarking:

- ♦ **It does not impair the image.** This is mainly the case with visible watermarks; even though you can see the watermark, it must be done in such a way that you can still see what the underlying image is. If it blocks large portions of the image or the entire image, it is not an effective watermark.
- ♦ **It cannot be removed.** There is no point in watermarking an image if someone can easily remove the watermark. The typical litmus test with digital watermarks is if the watermark is removed, the image should be impaired or destroyed.

- ♦ **It embeds a small amount of information.** Digital watermarking is usually done to mark an image or to prove ownership. Therefore, only a small amount of data needs to be embedded within an image.
- ♦ **It repeats data.** Even though only a small amount of data is being embedded within an image it should be done in more than one place. This helps to ensure that it cannot be easily removed.

Digital Watermarking and Stego

Digital watermarking is one form of stego, but it has some unique characteristics. Table 15-1 shows the similarities and differences between digital watermarking and other forms of steganography.

<i>Characteristic</i>	<i>Steganography</i>	<i>Digital Watermarking</i>
Amount of data	As much as possible	Small amount
Ease of detection	Very difficult to detect	Not critical with visible watermarks
Ease of removal	Important that someone cannot remove	Important that someone cannot remove
Goal of an attacker	To detect the data	To remove the data
Goal of user	To hide information within a file so someone cannot detect it	To embed a signature to prove ownership
Current uses	Corporate espionage, covert communication by executives, drug dealers, terrorists	Protect rights of owners of digital images, video, or audio content

Though the basic premise of embedding one thing within another is common, the motivation of hiding is usually not present in watermarking, and the uses of watermarking are quite different than most other forms of steganography.

Uses of digital watermarking

There are many uses for digital watermarking, but most of them revolve around protecting intellectual property and being able to prove that a given digital file belongs to you. Artists and companies who want to display images a customer can

preview online before buying often use watermarking to differentiate between the preview and the real thing. Audio and video content protection also uses its own form of watermarks.

Most of the products on the market today revolve around those three areas: audio, video, and still images or pictures. Table 15-2 lists the main programs that are available for performing digital watermarking and a brief description of each.

Table 15-2
Digital Watermarking Products

<i>Product</i>	<i>Company</i>	<i>Web Site</i>	<i>Format</i>	<i>Description</i>
AudioMark	Alpha Tec Ltd	www.alphatec ltd.com/	Audio	Inserts and retrieves inaudible watermarks in audio files
Digimarc Watermarking Solutions	Digimarc	www. .digimarc .com	Image and documents	Patented technology that inserts and retrieves watermarks from a variety of file formats using a suite of products
EIKONAmark	Alpha-Tec Ltd	www.alphatecltd .com/	Image	Inserts and retrieves invisible watermarks in still images
Giovanni	BlueSpike	www.bluespike .com	Audio, Image and Text	Inserts and retrieves watermarks into image, audio, and text using cryptographic keys
SysCop	MediaSec Technologies	www.media sec.com	Audio, Image and Video	Water-marking technology for audio, image, and video
Verance	Verance	www.verance .com/verance .html	DVD-audio	Patented technology for inserting watermarks into DVD-audio and SDMI Phase 1 files
VideoMark	Alpha-Tec Ltd	www. .alphatecltd. com	Video	Inserts and retrieves invisible watermarks in video
VolMark	Alpha-Tec Ltd	www. .alphatecltd .com	3D Images	Inserts and retrieves 3D watermarks in grayscale and 3D images and volumes

Removing digital watermarks

The main goal of digital watermarking a graphic image is to make sure that someone cannot remove the watermark without seriously damaging the image.

One tool used to attack digital watermarks is Stir Mark, written by Fabien Petitcolas. Stir Mark is used to test the strength of digital watermarking technologies. You can add your own tests to the program, but it comes with three standard tests:

- ♦ **PSNR Test**—PSNR stands for the peak signal-to-noise ratio, which is essentially the peak signal versus the mean square error. The equation for PSNR is $PSNR = 20 \log_{10} (255/RMSE)$, where RMSE is the root mean squared error. Typical values for PSNR are between 20 and 40. Remember, when you are applying a digital watermark or any form of stego to an image, you are introducing errors. This test measures the PSNR before and after watermarking to identify such errors.
- ♦ **JPEG Test**—JPEG images are a compressed image format. This is why this format is typically used on the Internet. A BMP file that is a couple of megabytes in size when converted to JPEG most likely would be a couple hundred KB in size. Because JPEG is a compressed format, when other formats are converted to JPEG, they often lose information. This test converts various formats to JPEG to see the impact it has on the watermark.
- ♦ **Affine Test**—This test performs an affine transformation across the image. An affine transformation requires that two properties of an image must maintain after the transformation: Any point that lies on a line still must be on that line after transformation, and the midpoint of the line must stay the same. The transformation is performed to see what impact, if any, it has on the watermark.

In most cases, as Stir Mark performs its transformations and removes the watermark, the resulting image is destroyed.

Summary

The explosion of interest in steganography represents a number of technological capabilities suddenly recognized to be applicable to satisfying unfulfilled user needs. Steganography is a technology where modern data compression, information theory, spread spectrum, and cryptography technologies are recognized as being applicable to satisfying the need for privacy on the Internet.

Although some electronic (computer-based) steganography references can be found before 1995, most of the interest and action in the field has occurred in just the last 18 to 24 months. Research reporting in literature, news reports, and press

releases, new start-up companies, and entry into the field by established technology firms have been prevalent in the last couple years. The steganography methods themselves are rapidly evolving and becoming increasingly sophisticated.

Electronic steganography is at the early stages of its market life cycle. It has become a hot topic on the Internet in the context of electronic privacy and copyright protection. Several researchers are experimenting with different methods and seem driven by the potential to make money. Even though there are early entrepreneurial digital watermarking service offerings, the field is also attracting the attention of several large corporations (such as IBM, NEC, and Kodak). The field seems poised for rapid growth.



Applications of Secure/Covert Communication

There is great demand for security solutions in communication networks. Every type of network, irrespective of whether it is the age-old plain-old telephone service (POTS) or sophisticated, high-speed digital networks such as fiber-distributed data interface (FDDI) and integrated services digital network (ISDN), is surrounded by security threats, loopholes, and vulnerabilities. In today's environments, where commercial and defense systems rely heavily on network services and applications for faster, quality service, security issues stand foremost for consideration. Security has many dimensions, such as authentication, authorization, confidentiality, integrity, non-repudiation, timeliness, and so on. Different applications might require different scales of these features in accordance with various types of service. Selecting a particular subset of security features from among those available today makes for critical differences in the design of an application.

This chapter reviews some of the qualified cryptographic and encryption standards that have been successfully ported to various application and network requirements. Applications such as e-mail, virtual private networks (VPNs), Internet browsers (Secure Sockets Layer and Transport Layer Security Protocols), and so on are explained in terms of their security requirements and features. Most of present-day security systems' features, such as encryption, cryptography, key management, trust management, and so on are grounded in mathematical theorems and axioms that have proven to be secure and not easy to break. The well-known Public Key Infrastructure (PKI) and other modes of encryption systems stand as testimonials to such mathematical backgrounds.

CHAPTER 16



In This Chapter

General applications of encryption and steganography

How to use various encryption programs

How VPNs work and how they can be used



E-mail

Electronic mail (e-mail) services are highly demanded and attractive applications over the Internet. Many vendors, including Microsoft and Yahoo, have public domain e-mail services, which are basically offered without any cost. Not only does the public Internet offer e-mail services, but most corporate and military organizations are dependent on it for internal communication and data transfer. Each user is given a certain space for posting his or her messages. The users use a simple user identity/password combination to open their mailboxes to access their mail. The server provides a central repository for the incoming and outgoing mail to be placed.

POP/IMAP protocols

E-mail services use the Post Office Protocol (POP) or the Internet Message Access Protocol (IMAP) for mail delivery and reception. The POP and IMAP protocols are very similar in architecture and functionality, except for the fact that IMAP is an advanced version with some sophisticated features. One feature offered by the IMAP protocol is that the e-mail clients (usually programs such as Outlook Express, Evolution, and PINE) can search through the mail messages on the server directly without any transfer to the client-end machines. The POP mail server would be able to download messages to just one client-end system and not over numerous client stations. This gives the POP protocol higher robustness in client-server message management: the user can download and delete messages from the server at any point of time. With the IMAP protocol, server maintenance and controllability becomes highly complex and distributed. In contrast, the POP protocol does not provide for advanced off-line and disconnected mail processing services like the IMAP protocol. Another protocol similar to POP and IMAP is the Distributed Mail Systems Protocol.

From a security perspective, both POP and IMAP can use advanced encryption and authentication mechanisms, which makes them highly superior compared to public Internet-based e-mail services that usually lack those services. Protocols such as Multi-Purpose Internet Mail Extensions (MIME) and Pretty Good Privacy (PGP) are used to realize covertness and security. MIME refers to the formatting of different types of e-mail messages (audio, video, text, images, and so on) in a special encoding technique (Base64) for secure transfer. At the client end the encoding is decoded to receive the original message. Because MIME is a formatting technique, Web browsers can use it to display non-HTTP-based formats. In contrast, PGP accommodates for PKI-based security techniques.

Pretty Good Privacy

PGP was created by Phil Zimmermann in the late 1990s. PGP is a public key cryptography-based system for encrypting and transmitting e-mails and messages. Public key cryptographic systems work with two different keys for encryption and decryption, unlike symmetric key encryption schemes, which have the same key for both encrypting and decrypting. Note that in the public key system, only the corresponding decrypting key (of the encryption-decryption key pair) can be used for message decryption, nothing else. This makes it possible for the scheme to declare one of the keys to be public and the other to be private. The user would normally safeguard his or her private key and would not send it to any others (even to potential clients). The clients would use the public key, which is normally available from a central server, to encrypt messages to the user.

The different services provided by PGP are as follows:

- ♦ Digital signature
- ♦ Confidentiality
- ♦ Message compression
- ♦ Format conversion (radix-64)

Digital signatures are quite useful in authentication of the sender by the receiver and vice versa. The sender generates the message and also a *hash code* of the message to be delivered. Hash codes are strong, one-way functions that uniquely map a message with their generated code. A strong hash code should not generate the same hash code for two different messages. Moreover, it would be highly difficult to correlate the hash codes with the message itself. Hackers would not be able to find a pattern in the messages by monitoring patterns in different hash codes. Thus, the creation of the strong hash codes has to be highly independent of message correlations and mutually unique and exclusive. The digital signature scheme followed by PGP works as follows:

1. The client creates a hashed code of the message he wants to send to the receiver. It sends both the source message and the generated hash code, using a hash generation algorithm.
2. The sender encrypts both the message and the generated hash code using the sender's private key. This could be done together or the hash codes may be transmitted separately from the message. When multiple signatures are required on the same message, the respective hash codes are transmitted individually.

3. The receiver obtains the message along with the hash code and decrypts it using the publicly available sender's public key.
4. The receiver generates the hash code of the received message using the same hash code generator at the receiver's end.
5. The receiver can verify the sender's authenticity by comparing and matching the receiver-generated hash and the received hash. If they are found to be different, the receiver should suspect a transmission error or a false message.

PGP applies encryption to messages based on random 128-bit keys with a variety of encryption algorithms. When digital signature features are required, both the message digest and the message itself are encrypted using the same key. The key is called the *session key* and is transported to the receiver using PKI. Normally, the session key is bound only with a single message transfer and would be changed with every e-mail message that is delivered. This ensures that key reuse is avoided over a long period of time. Because public key encryption demands high computational costs, only the session key is used in the public key infrastructure. The following flow gives an analysis of how confidentiality is achieved using PGP:

1. The sender generates a random session key for encrypting the message using a preselected symmetric key algorithm.
2. The sender creates a random number used to encrypt the session key using the receiver's public key.
3. The message (usually the message itself and the hash generated out of the message encrypted using the sender's private key, if digital authentication is required.) is encrypted using the session key and transmitted.
4. The receiver decrypts the session key with its private key, obtained from the public key encrypted session key from the sender.
5. The receiver uses the session key (usually associated with a single e-mail message) to decrypt the message and the contained hash code.
6. The receiver can verify the digital signature of the sender with the sender's public key.

Kerberos

Kerberos is a high-end sophisticated network authentication and security protocol developed by the Massachusetts Institute of Technology (Project Athena, MIT) that has gained popularity among server implementations in recent years. The name is derived from a three-headed mythological Greek incarnation that stood guard over the entrance to Hades (or the world of the dead). Kerberos is a certificate-based authentication scheme that relies on stamped certificates of approval for an entity

to form a trustworthy central service. The central services, which are designated the job of verifying a user and promoting his authentication, are called *Certificate Authorities*. The certificate authority is an entrusted server that is trusted by both communicating ends (the client requesting a service and the server that addresses the client) as a middleman in asserting each other's validity. The functioning of the Kerberos protocol is quite simple, yet it encapsulates many security features.

The Kerberos protocol uses passwords and shared secret keys for mutual authentication between a client and the server. Passwords are simple validating metrics between two parties that provide validation of each other. For example, a client can verify itself to a server if it reveals to the servers the password that both of them mutually agreed upon at an earlier instance. The problem with such a scheme is that as the number of clients and servers on the network increases and each combination of them requires a unique password for mutual authentication, management of passwords and secret keys becomes quite cumbersome and tedious. Moreover, because exchange of passwords happens on the network, which is porous in many ways, chances of intruders intercepting the passwords and secret keys and using them to spoof both the client and the server, increases. As a remedy, security systems call for encryption and key management techniques to be incorporated during network transaction between the client and the server.

The Kerberos protocol is based on symmetric key exchange schemes for encryption and decryption. Research is being done to make the protocol work on more secure non-symmetric PKI encryption schemes. In symmetric key exchange encryption mechanisms the same key is used by the client and the server for both encryption and decryption. The basic problem, as previously stated, is in transporting the key involved to either end securely. The Kerberos protocol addresses this issue using certificate authority servers and specialized key exchange encryption techniques.

Not only does the Kerberos technology provide for encryption, but it also has a sound mechanism for client and server mutual authentication. The authentication process follows the basics of the Needham Schroeder authentication protocol. Such protocols are very efficient in preventing well-known *replay attacks* in client-server-based systems. Replay attacks are caused by an intruder monitoring and storing network transaction information over a period of time, and later using it against the intended parties. An intruder can basically capture valid network traffic, which would be authentic with the client and server. Later, when the client or the server is no longer active, the intruder can pose as the client or the server and initiate a session with the partner. Such attacks usually go unnoticed, so the client would not attempt to modify or decrypt the monitored packets, but just replies them at a later period. The Kerberos protocol uses timestamps that effectively eliminate an intruder from intercepting the exchange and playing it at a later point in time.

Authentication Servers

Authentication Servers are centralized entities that process the validity of a client or server to either party. Initiating a client and server communication scheme shall proceed if both the client and server are convinced of each other's identity. Provided the required validity, the client (normally the end that requests a communication process from the servers) can provide its name in clear text and a set of entries that is encrypted with a key. The entries could range from any form of the client's identity (such as the client's name) and a timestamp showing the current time when the client initiates the communication process. For the server to verify the client's authenticity, it must decrypt the information that was encrypted by the client and verify the plain text message. If it finds the message to be the same, the server validates the client as authentic. If the system demands mutual authentication, the server can send part of the message that the client previously sent, which the client can then decrypt with the same key for validation of the server (see Figure 16-1).

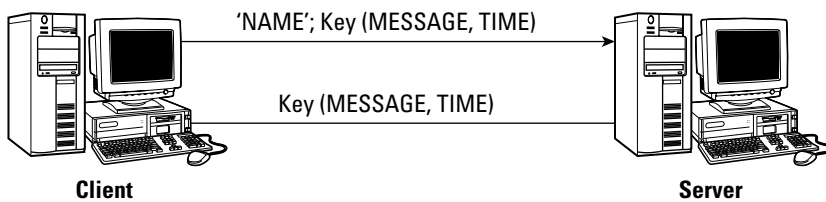

Figure 16-1: Client-Server Authentication

The method proposed with the preceding scheme would work fine when there is a way to distribute the key to both the server and the client securely. The client establishes its own validity to the authentication servers, which in turn pass the validation to the servers. The authentication server does not directly communicate with the server but uses the client itself and its encryption schemes to forward information to the server about the client. The authentication server encrypts (though not covertly) messages that it needs to pass on to the server through the client, which cannot decrypt it because it does not have the key. The client's job is then to pass the encrypted message to the server, so the server can decrypt and read the message. Thus, the authentication server provides for a method to securely transfer the validity of the client to the servers.

Working Model

In the Kerberos authentication scheme, the client is usually called the *principal* and the server the *verifier*. The third party in the scheme would be the authentication server. Every entity that uses Kerberos has to exchange a key with the authentication server. Therefore, the principal and the authentication server share a unique key that no one else knows. The user's key is normally a function of the password he chooses and is generated at the authentication server. The client uses certain standard symmetric encryption schemes, such as Data Encryption Standard (DES), to encrypt a sequence of messages along with certain plain text data for transmission to the authentication server. As the authentication server receives this message, it decrypts using the user's key and checks it against the plain text message. If the plain text message and the decrypted message prove to be the same, the authenticator is assured that the message originated from the legitimate user having that key. The presumption here on the part of the authentication server is that only the legitimate user would have access to the particular key.

Once the authentication server receives the request from the principal, it issues a *ticket* in response. The ticket is sent to the principal instead of the user-server. The ticket contains a newly generated key called the *session key*, and other strings of messages such as timestamps. But the authentication server user encrypts parts of the ticket (the timestamps, session key) using the server's key before transmitting it to the principal, which effectively prevents the principal from modifying it. The session key is also sent encrypted using the principal's key so that the principal can access it. The principal accesses the session key that is normally valid only for a certain period of time. The user passes information such as timestamps and so on in addition to the segment of the ticket that was encrypted using the user-server's key to the verifier.

The verifier on receiving this ticket from the principal decrypts it with the session key. The verifier receives the session key from the ticket that was issued to the principal from the authentication server that was relayed by the principal. The verifier gets the session key for communication with the user (for the allotted time) and uses the session key for further communication with the user. An interesting aspect would be when an intruder intercepts the authenticator response to communicate with the server at a later time. The possibility of this happening is negated by the user sending the timestamp to the verifier pointing to the user's local time. It is an assumption that the principal's and verifier's local clocks are synchronized to the time shown by the network clock. Otherwise, timestamping to point to the time of transmission would not work. To allow leeway for time skews the verifier accepts any timestamp from the user within a five-minute interval. There is usually a fourth transmission from the verifier to the principal in cases when mutual verification is required. The entire scenario is shown in Figure 16-2.

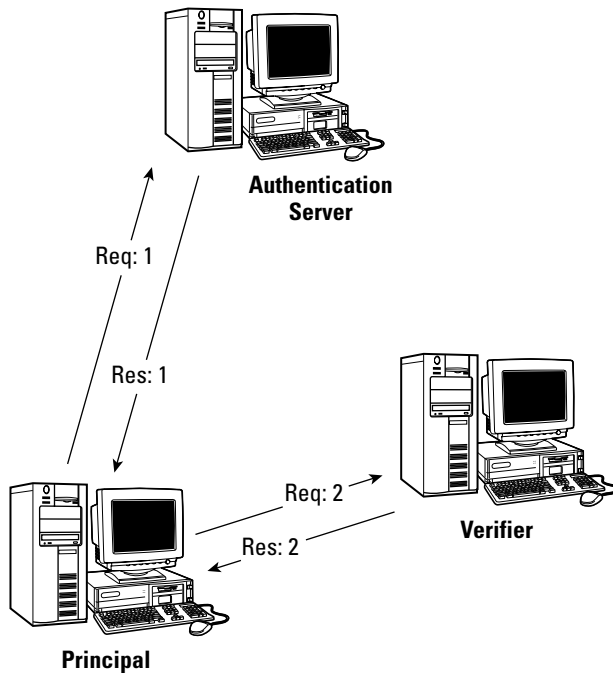

Figure 16-2: Client-server authentication in Kerberos

There have been serious reservations with this scheme because users have to type the user name and password every time they need authentications. This could be highly cumbersome and disadvantageous. From a security point of view, once a particular user has been authenticated as genuine, it is redundant to verify him or her often and could potentially lead to password sniffing and eavesdropping. The Kerberos authentication protocol takes care of this situation by introducing a new entity called the *ticket-granting ticket*.

Because it is highly disadvantageous to cache the user name/password combination at the local system, the system provides for caching the session tickets, which may not be as important as that of the password itself. The new system provides an entity called the ticket-granting server, which takes the role of issuing the tickets to the client to talk to the server. The authentication server grants tickets to the client through which the client can talk to the ticket-granting server. Thus, you see the need for only caching the ticket-granting tickets if you were to provide for continuous service to an authenticated client. Normally, the ticket-granting tickets have a relatively short lifespan (up to 10 hours) compared to a relatively long-lived user name/password. Figure 16-3 shows a description of the ticket-granting ticket scheme.

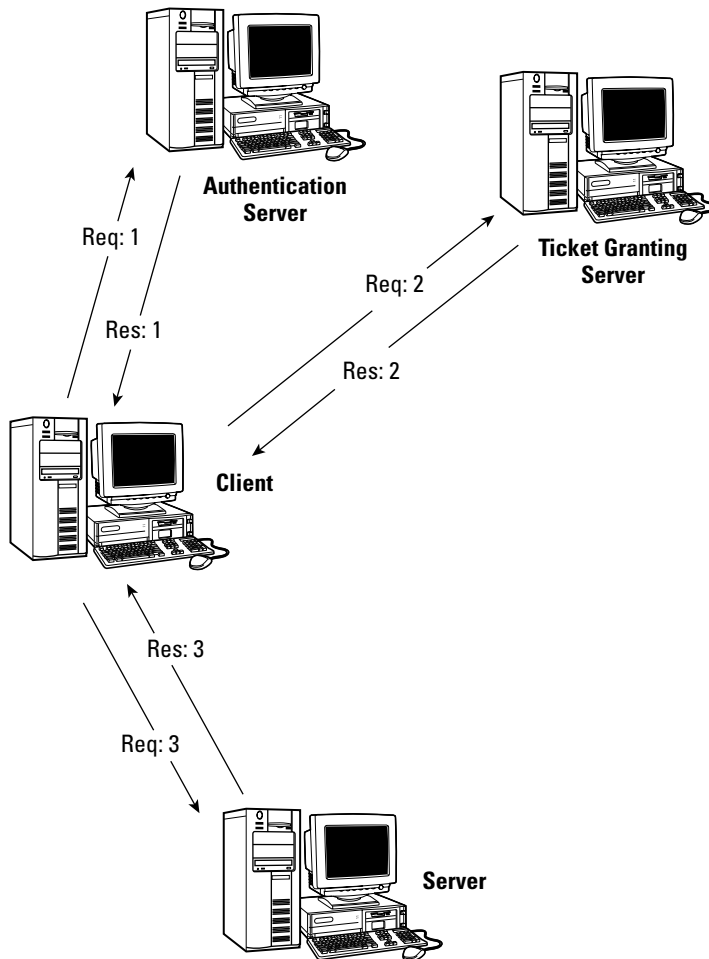

Figure 16-3: Ticket-granting server in the Kerberos Protocol

Public Key Infrastructure

Public Key Infrastructure (PKI) represents the community of technologies that facilitate secure communication using asymmetric public key encryption. The concept of public key encryption evolved when symmetric or secret key encryption technologies failed to lessen key management duties. Key management for secret key encryption techniques demanded that keys be transported from the source to the destination over a secure channel before communication could take place. Because keys travel past the same network that is thought insecure for transmitting data,

confidentiality of the keys cannot be guaranteed. The entire purpose of encryption can prove futile if an intruder intercepts such keys. In such a scenario, there is a need for highly sophisticated key management techniques, wherein transfer of keys from one point to another within an insecure network is minimized.

The core of PKI techniques lies in reducing insecure transmission of secret keys to achieve efficient key management. PKI makes use of two different keys that share a unique relationship with each other for purposes of encryption. The system provides for a public key and a private key that can be used interchangeably for encryption and decryption depending on the application and security requirements. The entire system is based on number theory concepts, utilizing the fact that factoring of large prime numbers is nearly impossible under present computation capacities. Because public key encryption systems can use only factors of prime numbers for its operations, the possibility of breaking it is extremely small. This explains why public key encryption schemes have larger bit numbers (in the range of 1024 to 2048 bits) than other secret key encryption techniques. Naturally, one could expect high computational costs involved with public key encryption schemes in comparison to other secret key encryption schemes. PKI aims to provide the following basic security features:

- ♦ **Confidentiality** — Data sent over the network is not available in a recognizable form to an intruder.
- ♦ **Integrity** — Data sent over the network is not modified by a third party during its transit to the receiver.
- ♦ **Authentication** — Data received by the receiver can be validated as to have originated from the genuine sender and not an impersonator.
- ♦ **Non-repudiation** — The sender cannot deny having sent information to the receiver at a later point of time, and the information could be used in a court of law as authentic from the sender.
- ♦ **Confirmation** — Information sent over a network reaches the intended destination safely and securely as verified by the sender.

Public and private keys

PKI provides for two different and complimentary keys for cryptography. One, called the public key component, is made available publicly and is available for any intended client to use from public repositories for encryption. In 1976, Whitfield Diffie and Martin Hellman proposed a sophisticated key exchange scheme that involved factors of exceptionally large prime numbers as keys for encryption. Both the public and private keys could be used interchangeably, which was highly useful in digital signature services where the private key is generally used for encryption and the private key for decryption.

This was a revolutionary development in the field of cryptography, as traditionally it was believed that encryption and decryption was possible only if a single and unique key was used. The concept of public key cryptography ushered in new dimensions in

most Web-based security services. Most of the network applications and services, such as Pretty Good Privacy, Kerberos, Secure Shell, and Transport Layer Security/Secure Sockets Layer, depend on PKI to function. More than encryption and authentication itself, PKI acts as a highly reliable way of key exchange and management. Later works (such as from Rivest-Shamir-Adleman) improved on the Diffie Hellman solution to make PKI highly reliable and robust for key exchange mechanisms. The following sections review how PKI brings in various security components.

Confidentiality

Confidentiality is generally brought about by encryption techniques. Public key encryption is usually heavy in computational intensity. For this reason, services do not use public key encryption to directly encrypt their messages. Normally a second layer of symmetric key encryption is included to encrypt the message intended to be transmitted. The session key is the symmetric key usually valid for a certain time period on both ends of the transmission. Public key encryption techniques are most often brought in to encrypt the session keys for the second layer symmetric key encryption to bring down the amount of computational intensity involved.

Digital Signature

Digital signatures provide authentication services of senders and receivers to each other. For a simple digital signature scheme the sender could encrypt his message using his private key and transmit it to the receiver along with a hash code. The receiver, on obtaining it, can verify the message to have originated from the sender when he verifies the hash and the decrypted message to be the same. Examples of hash-generating functions include Message Digest Algorithm (MD5) by Ronald Rivest and Secure Hash Algorithms (SHA). The receiver in this case uses the public key (which would be the unique partner) of the encrypting private key of the sender. The entire scheme is shown in Figure 16-4.

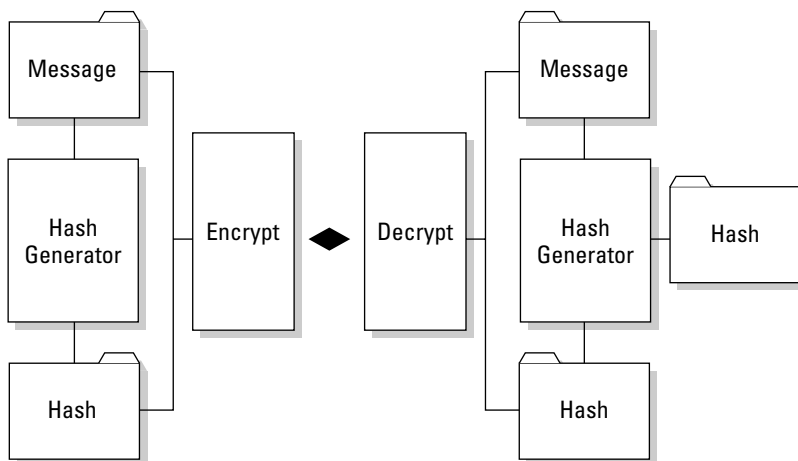

Figure 16-4: Digital signatures in PKI

Non-repudiation

Non-repudiation is a higher version of authentication. Though a variety of definitions exist for non-repudiation, it basically means that both the client and the receiver are sure of each other and that the transmitted message has not lost its integrity while being transmitted across the network. One can utilize the same digital signature scheme to attain the goal of non-repudiation. Though variants such as one-time pad (OTP) tokens may exist for non-repudiation for financial services, digital signatures based on PKI are a solid technology to achieve non-repudiation, which can be seen in Figure 16-4.

Key management

PKI defines two different keys for every entity involved in the transaction: A public key that can be released on a general forum for others to access and a private key intended for decryption and digital signature issuance. Questions arise as to how these keys are organized, found, and safeguarded. The certification authorities (CA) take on the task of issuing and managing keys in a PKI. The CA issues digital certificates by using a digital signature algorithm, which binds the identity of a user or system to a public key. Though the CA scheme draws some criticism, it is the single most trusted and prevalent key management scheme today. The CA normally issues the keys in the form of certificates (for example, Cisco X.509). These certificates, in addition to other details such as time of issuance of the certificate, name of the certificate, and so on, have the relevant public keys of the entities. Both the client and the server verify with the CA for issuance and verification of the other party's public keys.

Organizations can use their own CAs, in which case they build and maintain them. Products such as RSA Security's Key On can be used for this purpose. In most cases, organizations prefer to outsource their CAs to third-party vendors such as Verisign, Nortel Entrust, and so on. In either case, a safe and secure CA and its proper maintenance should be ensured for the proper functioning of a PKI. CAs usually work the same way as a passport issuing authority or a driver's license issuing authority. Once a valid document (a passport or a driver's license) has been issued, the user can carry it around freely to validate himself anywhere. The scrutinizer looks at the possession of such a document itself as a point of authentication of the carrier. However, just as passports and driver's licenses can be forged, certificates used in PKI could be, too. Measures such as implementation of time of validity and other encryption methods are used to prevent such spoofing of the certificate itself. As the trusted third party, CAs should be highly secure (in terms of being a highly respectable and indisputable body) so that such trusts can be maintained. Most financial transactions that take place through the Web demand such trust.

To identify and invalidate fraudulent certificates the CA maintains a Certificate Revocation List (CRL). CRLs are intended to revoke past dues and certificates that have been tampered with, which could potentially fall into the wrong hands and be

misused. Certificate expiration dates are not a substitute for a CRL, as the problem may be discovered while the certificate has not yet expired. The only problem that PKI encounters in its operation is key management. Essentially, it comes down to the validity of the CA itself. Because the CA is more often a large, centralized entity, any intrusion into it could potentially cause large-scale damage. The overtaking of a centralized entity on which an entire system depends for its parameters of operation (such as the CA in PKI) could cripple entire financial and government systems and should be protected against at all costs.

Web of trust

Web of trust is used in PKI-based e-mail systems such as PGP, GnuPG, and so on, in lieu of CAs. The CAs in conventional public key infrastructure are centralized entities. As discussed earlier, compromising such centralized entities on security issues can be difficult, but when a hacker manages it, it could prove very nasty to the concerned organizations. Instead, some e-mail and messaging systems follow a more distributed approach called the *web of trust*. In a web of trust, a person could be chained to others in a web for trust relations. For example, Alice could trust Ben and his certificate, Ben could trust Chris (and perhaps all of his friends), and so, in essence, Alice ends up trusting Chris in the chain. This is a simple linear chain of trust, but chains can become very complex when dealing with millions of users worldwide (PGP over the Internet, for example).

Signatures called the *trusted signature introducers* are normally introduced when dealing with entities that a user can trust. In the simplistic case, the introduced entity could act as the root CA. Root CAs can further have sub-certificate authorities, which are signed directly by the root CA. In the preceding example, Alice signs off Ben as the trusted signature introducer, who in turn signs Chris. Because Alice has a trust relationship with Ben, Chris can issue keys and certificates that Alice could use. Thus, the trust relation (web of trust) is maintained. Such relationship lineages can build up, leading to organizations trusting each other mutually. Though such schemes avoid centralized entities such as certificate authorities, problems can easily arise if a link in any part of the web is compromised. This is one of the important reasons that such distributed key management schemes are not implemented in secure organizations very often. However, public e-mail systems, such as PGP, have adopted the web of trust-based key management architectures quite successfully.

Virtual Private Networks

Virtual private networks (VPNs) have brought in high promises in the security front on the Internet and large-scale wide area networks (WANs). Though, realistically, security breaches cannot be avoided, the VPN stands as one of the strongest security backbones where WANs are concerned. Many vendors both in the commercial sector and in the defense sector see VPNs as a reliable source of tunneling and

security for their internal networks and the Internet. Setting up a VPN is relatively simple and highly secure and does not involve high operational costs. Many financial institutions looked at VPNs as a better option than other techniques for their network security requirements.

VPNs are most often used to connect the backbone Internet and ATM networks of an organization's central servers with its remote users and vice versa. If an organization's network is physically distributed across multiple locations (this range may include multiple countries), it can institute a VPN to interconnect the different network sections. An actual scenario is illustrated in Figure 16-5, where an organization utilizes VPNs to connect the various segments of its network. VPNs establish tunnels that allow sensitive data to be protected with encryption as it goes over public networks such as the Internet. In recent times, organizations that make use of the Internet as a means of establishing VPNs have had concerns about data security. Such demands have made VPNs evolve from a basic data transportation network to a system that also includes security features.

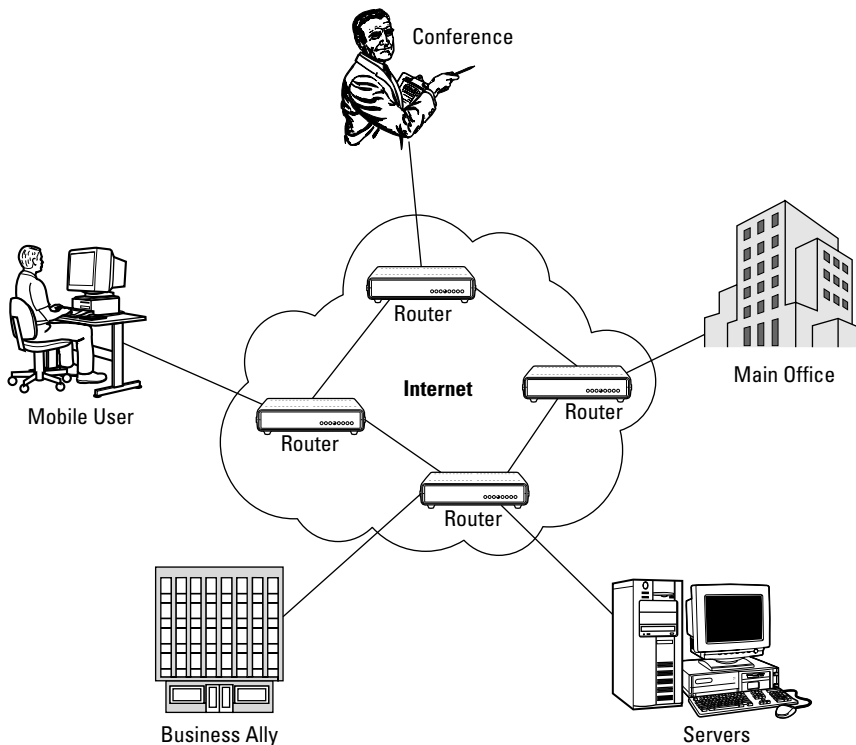

Figure 16-5: A typical VPN connection with different end domains

Design issues

VPNs are designed in accordance with an organization's application needs and network restrictions. More often than not, smaller organizations find it economical to deploy a low-end ISP-based solution, as opposed to other high-end, sophisticated alternatives. The fact that most VPN software lies on the client's machine and other remote location facilities (such as gateways and routers) makes it difficult to bring in standardization. The basic VPN architecture falls along the following lines:

- ♦ **Remote access VPNs**—Address the mobile end users' connectivity with a corporate main office network. End users (who are normally exclusive and authenticated customers) can log on to the remote access servers through dial-up services provided by an ISP. The corporation usually leaves its virtual private dial-up network in the hands of the network access servers (NAS) operated by the ISP. Normally, a login name and password are exchanged between the NAS for a user at the remote site to log in. This provides low-end solutions and relatively insecure VPNs, as the data may be sent out in the clear in the ISP's network. Figure 16-6 shows a remote access VPN.
- ♦ **LAN-to-LAN or site-to-site VPNs**—Another mode of virtual private networking is establishing communication between two different local area networks. An organization's business ally can use their networks to connect to the corporate network directly, combining two different large-scale networks into a single virtual network. Site-to-site VPNs require high-end solutions, as the amount of data exchanged is very high compared to with remote access VPNs. IP-Sec and SSL-based security and encryption solutions are used for building site-to-site VPNs. Figure 16-7 shows a site-to-site VPN.

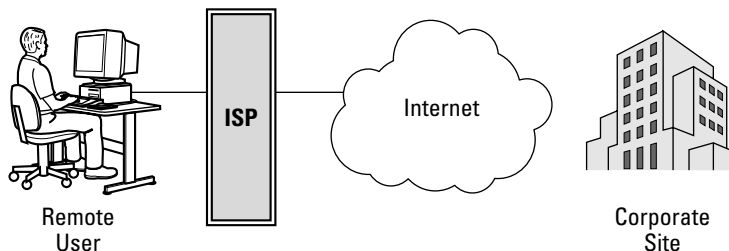

Figure 16-6: Remote access VPN

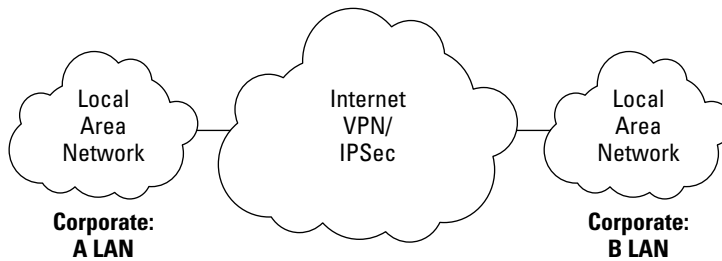

Figure 16-7: Site-to-site VPN

IPSec-based VPN

Internet Protocol–based security protocols are easy to develop and are highly scalable to any type of network and application. Essentially, IPs are used by almost all types of applications, which makes them a highly suitable medium for incorporating security-related protocols. Most application-level protocols and transport-level protocols do not provide highly standardized security features because different network services may use different application and transport level protocols. Though Transmission Control Protocol (TCP) enjoys a vast amount of utilization in the transport layer on the Internet, adding security features on top of it may be cumbersome compared to doing so on lower-level Internet protocols. Moreover, application-level encryption requires changes to be made at the application level, which is not standardized because of multiple vendors in the market. Thus, IPsec, an Internet layer security protocol, enjoys a major place in the security architecture of VPNs.

IPsec-based encryption schemes provide many different security features, including the following:

- ♦ Confidentiality
- ♦ Authentication
- ♦ Data integrity
- ♦ Protection against data replay attacks

They also encompass multiple security algorithm options. The user can decide which security algorithm to use for an application depending on the nature of security to be provided. Because IPsec provides for connection-oriented networks, unlike the conventional Internet Protocol, which is basically a connectionless protocol, a trusted key management facility has to be present for IPsec communication to take place effectively. Protocols such as the Internet Security Association, Key Management Protocol, and the Internet Key Exchange Protocol address the issues related to key management.

IPsec header modes

IPSec is categorized into two distinct modes, as follows:

- ♦ **Transport mode** — In the transport mode, the entire IP packet (the header and data fields) is not encapsulated, but appropriate changes are made to the protocol fields to represent it as a transport mode IPSec packet. Hosts have software directly installed on them to handle transport mode IPSec packets.
- ♦ **Tunneled mode** — In the tunneled mode of operation, complete encapsulation of the IP packet takes place in the data field of the IPSec packet. The routers and gateways are normally involved in handling and processing the IPSec packets in the transport mode, but tunneled mode can normally address destinations that may not be intended at the source, which provides for additional security as it conceals the source and destination field.

Special types of headers associated with the IPsec protocol make it different from the Internet Protocol. Two important modes of headers are recognized:

- ♦ Authentication Header
- ♦ Encapsulating Security Payload

Authentication Header

The Authentication Header (AH) consists of a set of fields, shown in Figure 16-8. The AH's basic purpose is to provide for data integrity during transmission and authenticate the source of the data to the receiver. Security associations (SAs) are connection-oriented paradigms that uniquely combine a particular source and destination during data transmission. SAs are used to store the parameters that each of the two parties use to make sure they utilize the same encryption schemes and key lengths during the communication. Authentication of the source and destination may be optionally accomplished when security associations are provided. AHs provide for the integrity of most parts of the data packet.

Next Header	Payload Length	Reserved
Security Parameters Index		
Sequence Number		
Authentication Data Field		

Figure 16-8: Authentication Header fields

- ♦ The Next Header shows the next protocol field on the normal IP packet before it was processed for IPsec features.
- ♦ The Payload Length indicates the length of the whole payload header in multiples of 4-byte words minus 2.
- ♦ The Security Parameters Index points to the destination IP and the security association involved. Information such as keys and algorithms used would be pointed out in this field.
- ♦ The Sequence Number keeps track of the number of packets sent and received in the particular security association. It is highly useful in avoiding replay attacks, which lead to multiple usages of the same packets by an interceptor at a later period of time.
- ♦ The Authentication Data Field consists of the various integrity check values for the packet as a whole (with some exceptions in the headers). This field can be used in digital signature processes wherein the receiver can verify the data to have originated from the authentic sender. Hash generator codes, such as hashed message authentication codes, are used for this purpose.

The disadvantage of the AH mode of IPsec protocols is that only integrity checking is offered; there is no confidentiality. Some of the fields in the header, such as those that can change during transit, may not be involved in the integrity check value calculation process. The next section talks about another sophisticated mode of the IPsec protocol, which handles the shortcomings of the AH mode.

Encapsulating Security Payload

The alternative to the AH mode IPsec header, Encapsulating Security Payload (ESP), provides for both authentication and confidentiality of the underlying IP packets, and works easily with IPv4 and IPv6 versions of the Internet Protocol. The basic architecture of the ESP mode header is shown in Figure 16-9.

ESP was released as an enhancement to the IPsec protocol under RFC 2406. ESP provides authentication, integrity, and confidentiality, which protects against data tampering and, most important, provides message content protection just as the Authentication Header protocol does. Anti-reply services are an added specialty in the ESP. The main difference between the AH protocol and the encapsulation header protocol is that the ESP protects for integrity and confidentiality only those components it encapsulates while, as previously mentioned, the AH provides integrity checks for most parts of the header and parts of the data fields, too. A restriction thus placed on the AH is that it has to be upper-layer protocol aware, which, in most cases, adds up to the overhead. Moreover, the AH protocol relies on other services for providing confidentiality, whereas ESP provides for confidentiality on its own. Outside the United States there are numerous restrictions on extending cryptographic confidentiality algorithms, which makes ESP's usage quite restricted. ESP has a mere optional usage in IPv6 as a result of such export restrictions. However, because the Authentication Header protocol does not have any such export restriction, it is available in the IPv6 protocol.

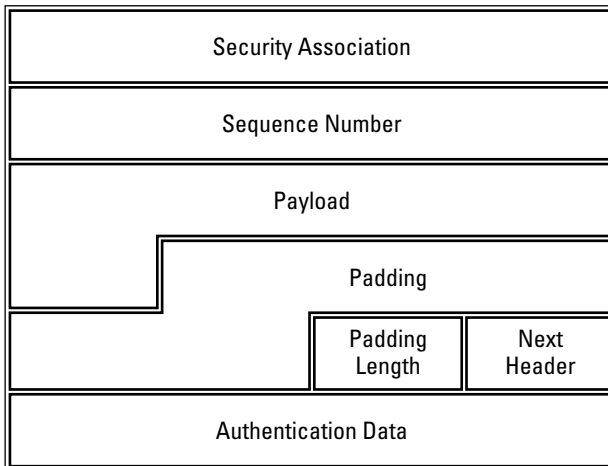

Figure 16-9: Encapsulation Security Protocol fields

PPTP/PPP-based VPNs

The Point-to-Point Tunneling Protocol (PPTP) is a networking technology that was brought about by Microsoft and an allied group of vendors towards virtual private networking. It does not use IPSec-based technologies and was intended for more portability. In most cases, the use of IPSec-based VPN protocols would require special software for operation. Microsoft has attempted to use its Windows-based operation systems for virtual private networking through the PPTP. In most PDAs that currently lack IPSec support, the PPTP could be an immediate alternative for virtual private networking. On the security front, the PPTP may not be as effective as that of the IPSec. IPSec uses higher-bit 3DES encryption as compared to the PPTP's MPPE encryption because of the key length. The longer the key length, the harder it is for someone to crack it with a brute-force attack. However, because export restrictions make the IPSec unusable outside the United States, the PPTP is much more prevalent.

PPTP is a direct implementation and enhancement of the more famous Point to Point Protocol (PPP). Through PPTP, it is possible for remote users to access their corporate networks and applications by dialing into the local ISP instead of dialing directly into the company network. PPP specifies means of implementing dial-up access from the user to the ISP's Point of Presence, which is extended by the PPTP all the way to the remote access server. Though the PPTP is a highly utilitarian system in providing simple virtual private networking across long distances, its security and robustness can cause issues.

Secure Shell

Remote users rely on remote login programs, such as rsh, ftp, rlogin, rcp, and so on, for attaining connectivity to host machines for application needs. Over the years, much of the activity on client server systems would be categorized as confidential and proprietary to the involved organizations. These demands brought up the issue of security in remote login programs so that information transmitted can be secure and verifiable. Secure Shell (SSH), maintained by the Internet Task Engineering Force, addresses this issue with remote login programs such as telnet and ftp. SSH services have comparatively higher security than services such as telnet. SSH is now available as the standard for remote computer logins, with an estimated five million users in more than 100 countries. Typical applications of SSH include remote access to computer resources over the Internet, secure file transfers, and remote system administration. SSH services use public key encryption schemes for providing data confidentiality and authentication. Although SSH services are most suitable and intended for UNIX and UNIX-like operating environments, non-UNIX operating systems, such as Microsoft NT and Macintosh, have also been known to use it.

The SSH service has been released in two different versions, SSH I and SSH II. Version I is an earlier version of the service and does not lend itself to high-end organizational demands. Version I was completely revised in creating version II. In fact, there were so many changes between the first and second versions that version II lost its compatibility with version I. Some of the features incorporated in the second version to make it highly robust and secure are as follows:

- ♦ Complete replacement of conventional remote login programs, such as ftp, telnet, rlogin and so on, with their security-compatible counterparts, such as scp, sftp, sshd, and ssh-agent.
- ♦ Availability of numerous choices for encryption, including algorithms such as Blowfish, DES, Triple-DES, AES, Two Fish, IDEA, and so on
- ♦ High-end security algorithms tailored to detect identity spoofing such as IP spoofing and other security threats
- ♦ Both transport and tunneling modes made possible for TCP/IP and other related protocol-based applications
- ♦ Authentication supported by algorithms such as DSA
- ♦ Multiple sessions for multiple terminal windows through one secure (authentication and encryption) connection

Secure Sockets Layer/ Transport Layer Security

The Secure Sockets Layer (SSL) was an initiation by the Internet Task Engineering Force (IETF) during the 1990s aimed at securing Web transactions for commerce and financial organizations. SSL works between the application and transport layers of the network protocol stack to ensure security of applications on the transport layer. SSL's basic aim is to provide authentication and integrity negotiation between applications involved. The negotiations can be used to decide on encryption algorithms to be used for the oncoming data exchange between the two parties. Today, most of the Web browsers, such as the Internet Explorer and Netscape Navigator, come with built-in SSL support that makes it quite transparent to the end user. The SSL operating environment is represented in Figure 16-10.

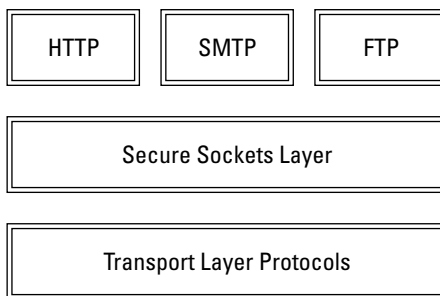

Figure 16-10: Functional layout of SSL

The most important feature is that it shields the operation of the underlying security functionalities of Web browsers from the users. Thus, the SSH technology is able to add advanced security features to the Web browsers. SSL relies on public key cryptography for mutual authentication, confidentiality, data integrity, and so on, on these Web browsers. The system provides for high-end security into the Web browsers for very little incremental cost. This leads to highly scalable architectures in Web browsers and applicability in financial transactions where mutual authentication and confidentiality services are provided. Most financial transactions require protection between the servers and the users when credit card purchases are made using online Web browsers. The servers require the verification of the user when remote users download proprietary and confidential information from an organization's server. There are three versions of the SSL protocol, but the first version was never released. SSL v2 has been integrated into Netscape Navigator for secure network transactions. SSL version 3 was released to fix some holes in the previous version.

SSL Handshake

The most basic component of SSL is the handshake protocol involved during its initiation. This enables the Web browser at the user end and the Web server to negotiate the security algorithms and protocol to initiate the sessions that the user has requested. Normally, because PKI is involved, the processing time for transactions is higher, but user transactions when dealing with secure sessions often is quite lengthy, thus accounting for the increased time it takes a transaction to occur. Figure 16-11 shows the digital signature process that would take place during the initial phase of the SSL handshake from the client side. The same process can be repeated from the server side to authenticate the client.

During the authentication process, the client and the server exchange “client hello” and “server hello” messages to ensure that the network connections are functioning without disruption. The “hello” messages also serve as a place for the server and client to verify each other’s functionality profiles. For example, if the server demands a strong 128-bit encryption but the client’s profile shows that it cannot handle it, the transaction fails with an error message.

Random numbers are exchanged during the client and server “hello” messages. The server issues a random number called the *session ID*, which can be used by the client for future communication with the servers. The session ID contains a time duration during which data can be reused between the client and the server and thus the validity or use of a normal handshake could be drastically reduced.

The server issues a digitally signed certificate, such as the X.509 certificate. This certificate contains information regarding the choices used for the data exchange, including the following:

- ♦ The signature algorithm
- ♦ Period of validity
- ♦ Public key encryption algorithm
- ♦ Certain extensions

Figure 16-12 shows the format of an X.509 certificate. The client verifies the certificate with a certificate authority, confirming the validity of the server. The server may in turn choose to do the same to verify the client. After the certificate has been verified, actual procedures for the data transaction begins. The server certificate also has a digital signature component that the client verifies if the certificate actually originated from the server. If not, the client could be spoofed by an intruder showing a valid certificate, yet not being the actual intended server.

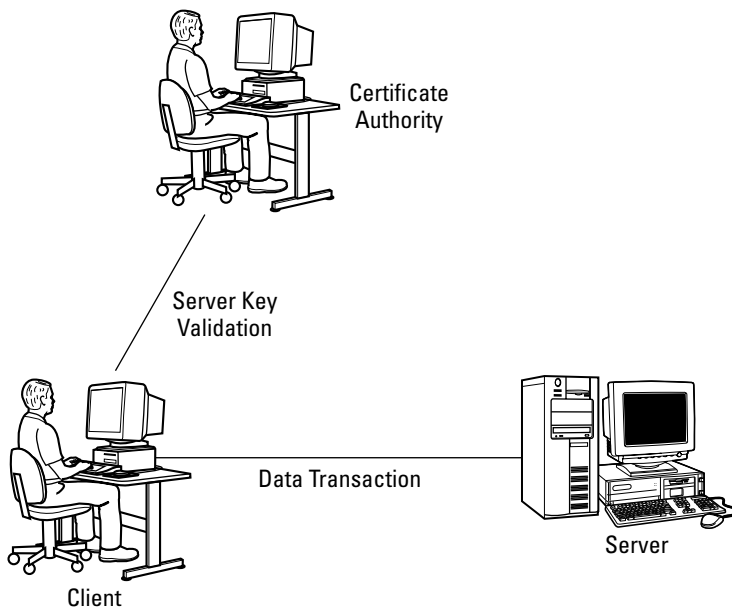

Figure 16-11: Authentication between the client and server

As soon as the client verifies the digital certificate from the server (which requires intense public key computations), the client generates secret key components for the session. A random key called the *pre-master key* is generated from the information obtained by the client from the transactions done with the server so far. The pre-master key has to be encrypted by the client and sent to the server in an exchange called the *client key exchange*. The client also creates the essential hashing and encryption algorithms that would be used to communicate with the server. The server upon receipt of the client key exchange message would proceed to decrypt the pre-master key that the client has sent it. Once the pre-master key is decrypted safely, the server uses the X.509 certificate to perform the same operations to get the hashing and encryption algorithms. Thus the SSL handshake protocol is able to mutually deliver the encryption and hashing components that can be used for data transmission to the client and the server.

Version
Serial Number
Digital Signature Algorithm
Issuer Name
Time Period of Validity
Name
Public Key Algorithm
Issuer Identifier
Subject Identifier
Extensions

Figure 16-12: X.509 certificate details

This is followed by the “change cipher spec” message initiated by the client and the “finish” message. The “change cipher spec” message is used to indicate that the handshake protocol has been properly executed and the data transaction using the encryption algorithms and keys can continue. The “finish” message further confirms the smooth transition from the SSL handshake to the SSL record mode. The SSL record protocol deals with the data transfer using the algorithms and keys negotiated by the SSL handshake protocol. The server in turn responds to the client’s “cipher change spec” message and the “finish” message with its own such messages. This completes the mutual handshake of the various negotiation terms during the handshake protocol. Figure 16-13 shows the various message exchanges involved in the SSL handshake protocol.

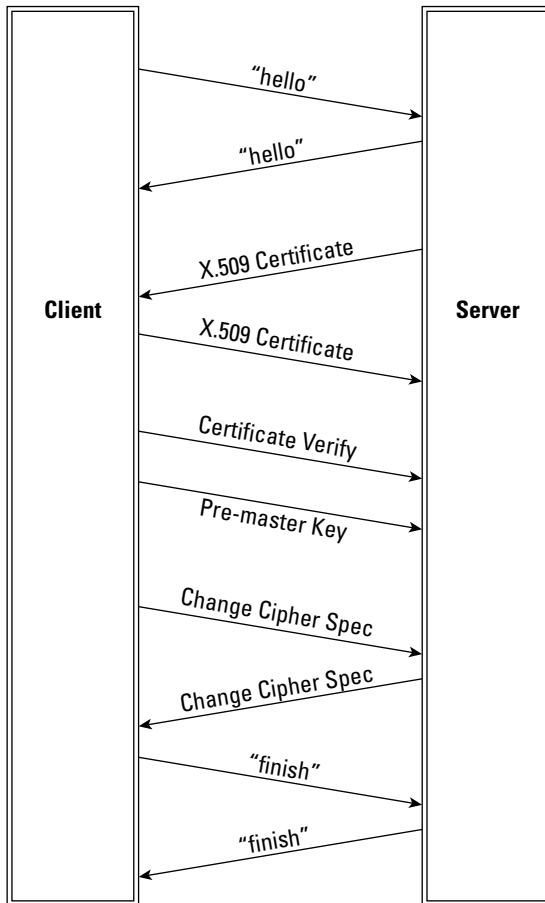

Figure 16-13: The SSL handshake protocol

The SSL handshake protocol is followed by the SSL record, which initiates data transfer at the negotiated parameters. The SSL record protocol makes use of record packets for transfer of data and encryption parameters. The record protocol may be followed by an alert protocol that issues warning or fatal error messages.

Though the SSL protocol may be very handy when dealing with Web-based transactions, there are certain areas in which the protocol may have disadvantages. The foremost is when firewalls are deployed at the server or client periphery. Since the data is encrypted it is highly impossible for any firewall to intercept any intruder who has compromised the PKI. For instance, an intruder may packet worms and

viruses against a server that the firewall may fail to intercept. Sophisticated firewall deployment is required to take advance security precautions. The PKI to be maintained required complex design features and not all certificate authorities are trustable. This causes chains of authority issues to be taken care in certificate authorities. Moreover, SSL requires quite high computational abilities on the part of both the client and the server, which may be an additional constraint.

The Transport Layer Security (TLS) layer protocol is an advanced version of the Secure Sockets Layer protocols and plugs in for some of the holes in the SSL protocol. The basic architecture of the TLS protocol is quite the same as that of the SSL protocol, yet with better security features. The difference lies in the choices of the hashing and public key encryption algorithms that SSL and TLS use for achieving their security features. Even though the difference between SSL and TLS is very small, they are quite incompatible with each other. Clients and servers need to have similar capabilities (either SSL or TLS) at both the ends to operate mutually.

Summary

Communication security will always be an important component in business and military transactions. More and more financial and commercial organizations are finding it feasible to utilize the Internet and other communicational networks for faster customer reach, production, and sales. In such a scenario, they cannot dispense with network security tools and their applications. With the changing facets of networking (wireless and mobile networks), security issues on these new network systems become a high-end challenge. Most vendors, including Cisco and Microsoft, have invested enormous time and attention in the emerging security implementations and applications.



The Security Threat and the Response

P A R T

V



In This Part

Chapter 17
Intrusion Detection
and Response

Chapter 18
Security Assessments,
Testing, and
Evaluation

Chapter 19
Putting Everything
Together



Intrusion Detection and Response

Detecting and responding to network attacks and malicious code is one of the principal responsibilities of information security professionals. Formal techniques and procedures have been developed by expert practitioners in the field to provide a structured approach to this difficult problem.

This chapter discusses these techniques as well as the different types of attacks and response mechanisms.

Malicious Code

Malicious code is intended to harm, disrupt, or circumvent computer and network functions. This code can be mobile, such as Java applets or code in the Active X environment. It can also attach itself to legitimate code and propagate; it can lurk in useful applications or replicate itself across the Internet. The following sections describe these different types of *malware*.

Viruses

A *virus* is code that attaches to a host program and propagates when the infected program is executed. Thus, a virus is *self-replicating* and *self-executing*.

Viruses are transmitted in a variety of ways, including as part of files downloaded from the Internet or as e-mail attachments.



In This Chapter

Describing the different types of malicious code

Reviewing common attacks

Understanding intrusion detection mechanisms

Understanding honeypots and their application

Reviewing incident handling



Viruses and closely related types of code fall into the following categories:

- ♦ **Macro viruses**— These viruses are one of the most common types found and infect applications such as Microsoft Word or Excel. Recall that a macro is a set of low-level instructions within an application that are useful in performing repetitive operations, including modifying and deleting files. In operation, macro viruses attach to an application's initialization sequence. When the application is opened, the virus executes instructions before transferring control to the application. Following this activity, the virus replicates itself and attaches to other code in the computer system.
- ♦ **File infectors**— File infector viruses usually attach themselves to executable code, such as `.com` or `.exe` files. The virus is then installed when the code is loaded. Another version of a file infector associates itself with a file by creating a virus file with the same name, but with an `.exe` extension. Therefore, when the file is opened, the virus file will execute.
- ♦ **System or boot-record infectors**— Boot-record viruses attach to the master boot record on hard disks or the boot sector on diskettes. When the system is started, it will look at the boot sector and load the virus into memory, where it can propagate to other disks and computers.
- ♦ **Polymorphic viruses**— These viruses conceal themselves from identification through varying cycles of encryption and decryption. They employ a variety of different encryption schemes requiring different decryption routines. In practice, the encrypted virus and an associated mutation engine are, initially, decrypted by a decryption program. The virus proceeds to infect an area of code. The mutation engine then develops a new decryption routine and the virus encrypts the mutation engine and a copy of the virus with an algorithm corresponding to the new decryption routine. The encrypted package of mutation engine and virus are attached to new code and the process repeats.
- ♦ **Multipartite viruses**— This type of virus has the same characteristics of boot sector and file infector viruses.
- ♦ **Stealth viruses**— Stealth viruses take over system functions to conceal themselves. They do this by compromising virus-scanning software so that the software will report an infected area as being uninfected. These viruses conceal any increase in the size of an infected file or changes to the file's date and time of last modification.
- ♦ **Trojan horses**— A Trojan horse is a program that hides in a useful program and usually has a malicious function. A major difference between viruses and Trojan horses is that Trojan horses do not self-replicate. In addition to launching attacks on a system, a Trojan horse can establish a back door that can be exploited by attackers. For example, a Trojan horse can be programmed to open a high-numbered port, which could be scanned and make the system vulnerable to attackers.

- ♦ **Logic bombs**—A logic bomb is malicious code that is appended to an application and is triggered by a specific occurrence, such as a logical condition, a specific time, a specific date, and so on.
- ♦ **Worms**—Worms differ from viruses in that they do not attach to a host file, but are self-contained programs that propagate across networks and computers. Worms are commonly spread through e-mail attachments, which, when opened, activate the worm program. A typical worm exploit would involve the worm sending a copy of itself to everyone in an infected computer's e-mail address book. In addition to conducting malicious activities, a worm spreading across the Internet and overloading e-mail servers can result in denial-of-service attacks against nodes on the network.
- ♦ **Droppers**—A dropper is a program used to install viruses on computers. In many instances, the dropper is not infected with malicious code and, therefore, might not be detected by virus-scanning software. A dropper can also connect to the Internet and download updates to virus software that is resident on a compromised system.

Review of Common Attacks

Attacks against network resources are common in today's Internet-dependent world. Attacks are launched for a variety of reasons, including monetary gain, maliciousness (as a challenge), fraud, warfare, and to gain an economic advantage. Attacks are directed at compromising the confidentiality, integrity, and availability of networks and their resources and fall into the following four general categories:

- ♦ **Modification attack**—Unauthorized alteration of information
- ♦ **Repudiation attack**—Denial that an event or transaction ever occurred
- ♦ **Denial-of-service attack**—Actions resulting in the unavailability of network resources and services, when required
- ♦ **Access attack**—Unauthorized access to network resources and information

Specific instantiations of these types of attacks are discussed in the following sections.

Denial-of-service/Distributed denial-of-service attacks

A denial-of-service (DoS) attack hogs or overwhelms a system's resources so that it cannot respond to service requests. A DoS attack can be effected by flooding a server with so many simultaneous connection requests that it cannot respond. Another approach would be to transfer huge files to a system's hard drive, exhausting all its storage space. A related attack is the distributed denial-of-service (DDoS)

attack, which is also an attack on a network's resources, but is launched from a large number of other host machines. Attack software is installed on these host computers, unbeknownst to their owners, and then activated simultaneously to launch communications to the target machine of such magnitude as to overwhelm the target machine.

Examples of DoS attacks include the following:

- ♦ **Buffer overflow**—A process receives much more data than expected. If the process has no programmed routine to deal with this excessive amount of data, it acts in an unexpected way that the intruder can exploit. For example, a ping-of-death attack exploits the Internet Control Message Protocol (ICMP) by sending an illegal ECHO packet of more than 65K octets of data, which can cause an overflow of system variables and lead to a system crash.
- ♦ **SYN Attack**—In this attack, an attacker exploits the use of the buffer space during a Transmission Control Protocol (TCP) session initialization handshake. The attacker floods the target system's small "in-process" queue with connection requests, but it does not respond when a target system replies to those requests. This causes the target system to time out while waiting for the proper response, which makes the system crash or become unusable.
- ♦ **Teardrop Attack**—The length and fragmentation offset fields in sequential Internet Protocol (IP) packets are modified. The target system then becomes confused and crashes after it receives contradictory instructions on how the fragments are offset on these packets.
- ♦ **Smurf**—This attack involves using IP spoofing and the ICMP to saturate a target network with traffic, thereby launching a DoS attack. It consists of three elements: the source site, the bounce site, and the target site. The attacker (the source site) sends a spoofed ping packet to the broadcast address of a large network (the bounce site). This modified packet contains the address of the target site. This causes the bounce site to broadcast the misinformation to all of the devices on its local network. All of these devices now respond with a reply to the target system, which is then saturated with those replies.

Back door

A back door attack takes place using dial-up modems or asynchronous external connections. The strategy is to gain access to a network through bypassing of control mechanisms by getting in through a back door such as a modem.

Spoofing

IP spoofing is used by an intruder to convince a system that it is communicating with a known, trusted entity to provide the intruder with access to the system. IP spoofing involves an alteration of a packet at the TCP level, which is used to attack

Internet-connected systems that provide various TCP/IP services. In this exploit, the attacker sends a packet with an IP source address of a known, trusted host instead of its own IP source address to a target host. The target host may accept the packet and act upon it.

Man-in-the-middle

A man-in-the-middle attack involves an attacker, A, substituting his or her public key for that of another person, P. Then, anyone wanting to send an encrypted message to P using P's public key is unknowingly using A's public key. Therefore, A can read the message intended for P. A can then send the message on to P, encrypted in P's real public key, and P will never be the wiser. Obviously, A could modify the message before resending it to P.

Replay

A replay attack occurs when an attacker intercepts and saves old messages and then tries to send them later, impersonating one of the participants. One method of making this attack more difficult to accomplish is through the use of a random number or string, called a *nonce*, that changes with time. If Bob wants to communicate with Alice, he sends a nonce along with the first message to Alice. When Alice replies, she sends the nonce back to Bob, who verifies that it is the one he sent with the first message. Anyone trying to use these same messages later will not be using the newer nonce. Another approach to countering the replay attack is for Bob to add a timestamp to his message. This *timestamp* indicates the time that the message was sent. Thus, if the message is used later, the timestamp will show that an old message is being used.

TCP/Hijacking

An attacker hijacks a session between a trusted client and network server. The attacking computer substitutes its IP address for that of the trusted client and the server continues the dialog believing it is communicating with the trusted client. Simply stated, the steps in this attack are as follows:

1. A trusted client connects to a network server.
2. The attack computer gains control of the trusted client.
3. The attack computer disconnects the trusted client from the network server.
4. The attack computer replaces the trusted client's IP address with its own IP address and spoofs the client's sequence numbers.
5. The attack computer continues dialog with the network server (and the network server believes it is still communicating with trusted client).

Fragmentation attacks

A fragmentation attack is used as a method of getting packets around a packet filtering firewall. In a basic fragmentation attack, packets are broken into fragments with the first packet containing the complete header data. The remaining packets do not contain any header information. Because some routers filter packets based on this header information, the remaining packets without header data are not filtered and pass through the firewall.

Two examples of fragmentation attacks follow:

- ♦ A *tiny fragment attack* occurs when the intruder sends a very small fragment that forces some of the TCP header field into a second fragment. If the target's filtering device does not enforce minimum fragment size, this illegal packet can then be passed on through the target's network.
- ♦ An *overlapping fragment attack* is another variation on a datagram's zero-offset modification (similar to the teardrop attack). Subsequent packets overwrite the initial packet's destination address information, and then the second packet is passed by the target's filtering device. This action can happen if the target's filtering device does not enforce a minimum fragment offset for fragments with non-zero offsets.

Weak keys

For many cryptographic algorithms, some keys are weaker than others (that is, some keys are not as secure as other keys). Strong keys are generated using truly random number generators. For specific algorithms, keys can be tested for their strength. For example, the data encryption standard, DES, has only 16 weak keys out of its 2^{56} possible keys. Because weak keys for an algorithm can be identified, they should not be used.

When an algorithm has keys that are all of equal strength, it is said to have a *linear* or *flat key space*. Conversely, if an algorithm has keys that are not all of equal strength, it has a *nonlinear key space*.

The same use of randomness applies to passwords in that the more random the choice of letters and characters in a password, the more secure the password is. However, the more random the sequence of letters and characters in a password, the more difficult it is for a person to remember.

Mathematical attacks

Mathematical attacks refer to the use of mathematics to break passwords or cryptographic algorithms as opposed to other approaches, such as brute force, which try all possible combinations of patterns.

A good example of a mathematical attack is the use of factoring algorithms to break the RSA public key cryptography algorithm. Recall that the hard problem in RSA is determining the prime factors of a large number. Numbers on the order of 129 digits have been factored using factoring algorithms and thousands of computers on the Internet. One of the better factoring algorithms is the number field sieve (NFS).

Social engineering

This attack uses social skills to obtain information such as passwords or PIN numbers to be used against information systems. For example, an attacker may impersonate someone in an organization and make phone calls to employees of that organization requesting passwords for use in maintenance operations. The following are additional examples of social engineering attacks:

- ♦ E-mails to employees from a cracker requesting their passwords to validate the organizational database after a network intrusion has occurred
- ♦ E-mails to employees from a cracker requesting their passwords because work has to be done over the weekend on the system
- ♦ E-mails or phone calls from a cracker impersonating an official who is conducting an investigation for the organization and requires passwords for the investigation
- ♦ Improper release of medical information to individuals posing as doctors and requesting data from patients' records
- ♦ A computer repair technician convincing a user that the hard disk on his or her PC is damaged and unrepairable and installing a new hard disk for the user, the technician then taking the original hard disk to extract information and sell the information to a competitor or foreign government

The best defense against social engineering attacks is an information security policy addressing social engineering attacks and educating the users about these types of attacks.

Port scanning

A cracker can use scanning software to determine which hosts are active and which are down to avoid wasting time on inactive hosts. A port scan can gather data about a single host or hosts within a subnet (256 adjacent network addresses). A scan can be implemented using the Ping utility. After determining which hosts and associated ports are active, the cracker will initiate different types of probes on the active ports. Examples of probes are as follows:

- ♦ Gathering information from the Domain Name System (DNS)
- ♦ Determining the network services that are available, such as e-mail, FTP, and remote logon
- ♦ Determining the type and release of the operating system

Dumpster diving

Dumpster diving involves the acquisition of information that is discarded by an individual or organization. In many cases, information found in trash can be very valuable to a cracker. Discarded information may include technical manuals, password lists, telephone numbers, and organization charts. It is important to note that one requirement for information to be treated as a trade secret is that the information be protected and not revealed to any unauthorized individuals. If a document containing an organization's trade secret information is inadvertently discarded and found in the trash by another person, the other person can use that information because it was not adequately protected by the organization.

Birthday attacks

Birthday attacks are made against hash algorithms that are used to verify the integrity of a message and for digital signatures. A message processed by a hash function produces an output message digest (MD) of fixed length, independent of the length of the input message. The MD uniquely characterizes the message. For a strong hash algorithm, H , and message M , the following is true:

- ♦ It should be computationally infeasible to find two messages that produce a common message digest (that is, $H(M1) \neq H(M2)$).
- ♦ If there exist a message and its corresponding message digest, it should be computationally infeasible to find another message that generates that specific message digest.
- ♦ It should be computationally infeasible to find a message that corresponds to a given message digest.
- ♦ The message digest should be calculated using all of the data in the original message.

The birthday attack refers to the probability of finding two random messages that generate the same MD when processed by a hash function. This question is analogous to asking how many people must be in a room to have a greater than 50 percent chance of at least two of them having the same birthday. The answer is 23.

Password guessing

Because passwords are the most commonly used mechanism to authenticate users to an information system, obtaining passwords is a common and effective attack approach. Access to a person's password can be obtained by looking around their desk for notes with the password, "sniffing" the connection to the network to acquire unencrypted passwords, through social engineering, gaining access to a password database, or outright guessing. The last approach can be done in a random or systematic manner.

Brute force

Brute-force password guessing means using a random approach by trying different passwords and hoping that one works. Some logic can be applied by trying passwords related to the person's name, job title, hobbies, or other similar items.

Dictionary attack

A dictionary attack is one in which a dictionary of common passwords is used in an attempt to gain access to a user's computer and network. One approach is to copy an encrypted file that contains the passwords and, applying the same encryption to a dictionary of commonly used passwords, compare the results. This type of attack can be automated.

Software exploitation

Vulnerabilities in software can be exploited to gain unauthorized access to information systems' resources and data. Some examples of software exploitation follow:

- ♦ **AIX operating system** — Passwords can be exposed by diagnostic commands.
- ♦ **Novell Web server** — An attacker can cause a DoS buffer overflow by sending a large GET request to the remote administration port. This causes the data being sent to overflow the storage buffer and reside in memory as executable code.
- ♦ **IRIX operating system** — A buffer overflow vulnerability enables root access by an attacker.
- ♦ **Windows 9x** — A vulnerability enables an attacker to locate system and screensaver passwords, thereby providing the attacker with means to gain unauthorized log on access.
- ♦ **Windows NT and XP** — Privilege exploitation software used by an attacker can gain administrative access to the operating system.

Many software-related vulnerabilities can be avoided by applying good software-engineering techniques during the software development process and anticipating possible attacks. For example, proper parameter checking can be incorporated into software to prevent buffer overflow attacks.

Additional software-related issues are described as follows:

- ♦ **Antivirus management**—If personnel can load or execute any software on a system, the system is more vulnerable to viruses, unexpected software interactions, and to the subversion of security controls.
- ♦ **Software testing**—A rigid and formal software testing process is required to determine compatibility with custom applications or to identify other unforeseen interactions. This procedure should also apply to software upgrades.
- ♦ **Software utilities**—System utilities can compromise the integrity of operating systems and logical access controls. Their use must be controlled by a security policy.
- ♦ **Safe software storage**—A combination of logical and physical access controls should be implemented to ensure that the software and copies of backups have not been modified without proper authorization.

Inappropriate system use

This activity relates to the use of business computers and resources for non-business or personal use, such as downloading inappropriate material from the Internet, conducting personal stock trading transactions, making personal travel reservations, conducting outside business, and so on. Strictly speaking, this is an attack against an organization's resources by using them for unauthorized purposes.

Eavesdropping

Eavesdropping attacks occur through the interception of network traffic. This situation is particularly prevalent when a network includes wireless components and remote access devices. By eavesdropping, an attacker can obtain passwords, credit card numbers, and other confidential information that a user might be sending over the network. Examples of the various manners of eavesdropping include the following:

- ♦ **Passive eavesdropping**—Unauthorized, covert monitoring of transmissions
- ♦ **Active eavesdropping**—Probing, scanning, or tampering with a transmission channel to access the transmitted information

War driving

In war driving or walking, an attacker scans for 802.11-based wireless network information by using a laptop computer with a wireless adapter in promiscuous mode and scanning software such as NetStumbler. Also, a Global Positioning System (GPS) might be used to note the location of compromised nodes.

TCP sequence number attacks

In this type of attack, the attacker makes the target believe it is connected to a trusted host and then hijacks the session by predicting the target's choice of an initial TCP sequence number. This session is then often used to launch various attacks on other hosts.

War dialing/demon dialing attacks

In war dialing, an attacker uses a program that automatically places calls to a group of telephone numbers in hopes of finding numbers that are connected to modems. In demon dialing, a brute-force, password-guessing approach is used to gain access to a system through a modem.

Intrusion Detection Mechanisms

Intrusion detection (ID) comprises a variety of categories and techniques. The prominent approaches involve determining if a system has been infected by viruses or other malicious code and applying methods for spotting an intrusion in the network by an attacker. Virus-scanning and infection-prevention techniques are used to address the virus problem and intrusion detection and response mechanisms target network intrusions.

Antivirus approaches

Virus scanning and virus prevention techniques are normally used to prevent viruses from compromising valuable network resources.

Virus scanners

Virus scanners use pattern-matching algorithms that can scan for many different signatures at the same time. These algorithms include scanning capabilities that detect known and unknown worms and Trojan horses. These products scan hard disks for viruses and, if any are found, remove or quarantine them. Antivirus software also performs auto-update functions that automatically download signatures of new viruses into the virus-scanning database.

Virus prevention

Virus prevention software usually resides in memory and monitors system activity, or filters incoming executable programs and specific file types. When an illegal virus accesses a program or boot sector, the system is halted and the user is prompted to remove that particular type of malicious code.

Intrusion detection and response

Intrusion detection and response is the task of monitoring systems for evidence of intrusions or inappropriate usage and responding to this evidence. Response includes notifying the appropriate parties to take action to determine the extent of the severity of an incident and to remediate the incident's effects. ID, therefore, is the detection of inappropriate, incorrect, or anomalous activity.

An intrusion detection and response capability has two primary components:

- ♦ Creation and maintenance of intrusion detection systems (IDSs) and processes for host and network monitoring and event notification
- ♦ Creation of a computer incident response team (CIRT) for the following tasks:
 - Analysis of an event notification
 - Response to an incident if the analysis warrants it
 - Escalation path procedures
 - Resolution, post-incident follow-up, and reporting to the appropriate parties

An IDS is a system that monitors network traffic or host audit logs to determine whether any violations of an organization's security policy have taken place. An IDS can detect intrusions that have circumvented or passed through a firewall or that are occurring within the local area network (LAN) behind the firewall.

Various types of IDSs exist. The most common approaches to ID are *statistical anomaly detection* (also known as behavior-based) and *signature-based* (also known as knowledge-based or pattern-matching) detection. Intrusion detection systems that operate on a specific host and detect malicious activity on that host only are called *host-based* ID systems. ID systems that operate on network segments and analyze that segment's traffic are called *network-based* ID systems. Because there are pros and cons of each, an effective IDS should use a combination of both network- and host-based IDSs. A truly effective IDS will detect common attacks as they occur, which includes distributed attacks.

Network-based IDSs

Network-based IDSs reside on a discrete network segment and monitor the traffic on that segment. They usually consist of a network appliance with a network interface card (NIC) that is operating in promiscuous mode and is intercepting and analyzing the network packets in real time.

A network-based IDS involves looking at the packets on the network as they pass by some sensor. The sensor can only see the packets that happen to be carried on that particular network segment. Network traffic on other segments and traffic on other means of communication (such as phone lines) can't be monitored properly by a network-based IDS.

Packets are identified to be of interest if they match a signature. Three primary types of signatures are as follows:

- ♦ **String signatures**—String signatures look for a text string that indicates a possible attack.
- ♦ **Port signatures**—Port signatures watch for connection attempts to well-known, frequently attacked ports.
- ♦ **Header condition signatures**—Header signatures watch for dangerous or illogical combinations in packet headers.

A network-based IDS usually provides reliable, real-time information without consuming network or host resources. A network-based IDS is passive when acquiring data and review packets and headers. It can also detect DoS attacks. Furthermore, because this IDS is monitoring an attack in real time, it can respond to an attack in progress to limit damage.

One problem with a network-based IDS system is that it will not detect attacks against a host made by an intruder who is logged in at the host's terminal. If a network IDS along with some additional support mechanism determines that an attack is being mounted against a host, it is usually not capable of determining the type or effectiveness of the attack being launched.

Host-based IDSs

Host-based IDSs use small programs (intelligent agents) that reside on a host computer. They monitor the operating system detecting inappropriate activity, writing to log files, and triggering alarms. Host-based systems look for activity only on the host computer; they do not monitor the entire network segment.

A host-based IDS can review the system and event logs to detect an attack on the host and to determine whether the attack was successful. Detection capabilities of host-based IDSs are limited by the incompleteness of most host audit log capabilities.

In particular, host-based IDSs have the following characteristics:

- ♦ They monitor accesses and changes to critical system files and changes in user privileges.
- ♦ They detect trusted insider attacks better than a network-based IDS.
- ♦ They are relatively effective for detecting attacks from the outside.
- ♦ They can be configured to look at all network packets, connection attempts, or login attempts to the monitored machine, including dial-in attempts or other non-network-related communication ports

An IDS detects an attack through one of two conceptual approaches: a signature-based IDS or a statistical anomaly-based IDS. These two mechanisms are also referred to as knowledge-based and behavior-based IDS, respectively.

Signature-based IDSs

In a signature-based IDS or knowledge-based IDS, signatures or attributes that characterize an attack are stored for reference. Then, when data about events is acquired from host audit logs or from network packet monitoring, this data is compared with the attack signature database. If there is a match, a response is initiated. This method is more common than using behavior-based IDSs. Signature-based IDSs are characterized by low false alarm rates (or positives) and, generally, are standardized and understandable by security personnel.

A weakness of the signature-based IDS approach is the failure to characterize slow attacks that extend over a long period of time. To identify these types of attacks, large amounts of information must be held for extended time periods. Another issue with signature-based IDSs is that only attack signatures that are stored in their database are detected. Additional disadvantages of signature-based IDSs include the following:

- ♦ The IDS is resource-intensive. The knowledge database continually needs maintenance and updating with new vulnerabilities and environments to remain accurate.
- ♦ Because knowledge about attacks is very focused (dependent on the operating system, version, platform, and application), new, unique, or original attacks often go unnoticed.

Statistical anomaly based IDSs

Statistical anomaly or behavior-based IDSs dynamically detect deviations from the learned patterns of “normal” user behavior and trigger an alarm when an intrusive activity occurs. Behavior-based IDSs learn normal or expected behavior of the system or the users and assume that an intrusion can be detected by observing deviations from this norm.

With this method, an IDS acquires data and defines a “normal” usage profile for the network or host that is being monitored. This characterization is accomplished by taking statistical samples of the system over a period of normal use. Typical characterization information used to establish a normal profile includes memory usage, CPU utilization, and network packet types. With this approach, new attacks can be detected because they produce abnormal system statistics. The advantages of a behavior-based IDS are as follows:

- ♦ The system can dynamically adapt to new, unique, or original vulnerabilities.
- ♦ A behavior-based IDS is not as dependent upon specific operating systems as a knowledge-based IDS.
- ♦ They help detect abuse-of-privileges types of attacks that do not actually involve exploiting any security vulnerability.

Some disadvantages of a statistical anomaly based IDS are that it will not detect an attack that does not significantly change the system-operating characteristics, and it might falsely detect a non-attack event that caused a momentary anomaly in the system. Also, behavior-based IDSs are characterized by the following:

- ♦ High false alarm rates. High positives are the most common failure of behavior-based ID systems and can create data noise that can make the system unusable or difficult to use.
- ♦ Activity and behavior of the users of a networked system might not be static enough to effectively implement a behavior-based ID system.
- ♦ The network may experience an attack at the same time the intrusion detection system is learning the behavior.

IDS issues

Many issues confront the effective use of an IDS. These include the following:

- ♦ Increases in the types of intruder goals, intruder abilities, tool sophistication, and diversity, as well as the use of more complex, subtle, and new attack scenarios
- ♦ The use of encrypted messages to transport malicious information

- ♦ The need to interoperate and correlate data across infrastructure environments with diverse technologies and policies
- ♦ Ever-increasing network traffic
- ♦ The lack of widely accepted IDS terminology and conceptual structures
- ♦ Volatility in the IDS marketplace, which makes the purchase and maintenance of IDSs difficult
- ♦ Risks inherent in taking inappropriate automated response actions
- ♦ Attacks on the IDSs themselves
- ♦ Unacceptably high levels of false positives and false negatives, making it difficult to determine true positives
- ♦ The lack of objective IDS evaluation and test information
- ♦ The fact that most computing infrastructures are not designed to operate securely
- ♦ Limited network traffic visibility resulting from switched local area networks (faster networks preclude effective real-time analysis of all traffic on large pipes)

An issue with the implementation of intrusion detection systems is the performance of the IDS when the network bandwidth begins to reach saturation levels. Obviously, there is a limit to the number of packets that a network intrusion detection sensor can accurately analyze in any given time period. The higher the network traffic level and the more complex the analysis, the more the IDS may experience high error rates, such as the premature discard of copied network packets.

Another issue with IDS is the proper implementation of IDS sensors in a switched environment. This issue arises from the basic differences between standard hubs and switches. Hubs exclude only the port the packet came in on and echo every packet to every port on the hub. Therefore, in networks employing only hubs, IDS sensors can be placed almost anywhere in the infrastructure.

However, when a packet comes into a switch, a temporary connection in the switch is first made to the destination port and then the packets are forwarded. This means more care must be exerted when placing IDS sensors in a switched environment to assure the sensor is able to see all of the network traffic.

Some switches permit spanning port configuration, which configures the switch to behave like a hub only for a specific port. The switch can be configured to span the data from a specific port to the IDS port. Unfortunately, some switches cannot be guaranteed to pass all the traffic to the spanned port, and most switches only allow one port to be spanned at a time.

Honeypots

A different approach to intrusion detection and response is the use of a *honeypot*. A honeypot is a monitored decoy mechanism that is used to entice a hacker away from valuable network resources and provide an early indication of an attack. It also provides for detailed examination of an attacker during and following a honeypot exploitation. A definition of a honeypot provided by Lance Spitzner, President of the HoneyNet Project, is, “an information system resource whose value lies in unauthorized or illicit use of that resource.” The HoneyNet Project is a non-profit research organization of volunteer security professionals dedicated to advancing the state of the art in information system security. More information on the HoneyNet Project is provided later in this chapter.

Purposes

Honeypots are employed primarily for either research or production purposes. In the research mode, a honeypot collects information on new and emerging threats, attack trends, motivations, and, essentially, characterizes the attacker community.

In the production category, honeypots are applied to preventing attacks, detecting attacks, and responding to attacks. The methods for accomplishing these tasks are summarized in the following sections.

Preventing attacks

Honeypots are effective in preventing attacks by doing the following:

- ♦ Slowing or impeding scans initiated by worms or automated attacks by monitoring unused IP space and detecting scanning activity
- ♦ Consuming an attacker’s energy through interaction with a honeypot while the attack is detected, analyzed, and handled
- ♦ Deterring an attack by a cracker who suspects a network employs honeypots and is concerned about getting caught

Detecting attacks

Network security, no matter how conscientiously and effectively applied, cannot prevent all attacks all of the time. Therefore, honeypots offer means to detect an attack that is taking place or has occurred. Honeypots have the following advantages in detecting attacks:

- ♦ The ability to capture new and unknown attacks
- ♦ The ability to capture polymorphic code

- ♦ They are capable of handling encrypted data
- ♦ They reduce the amount of data that has to be analyzed by capturing only attack information
- ♦ They are capable of operating with IPv6

Responding to attacks

Responding to an attack is challenging and not always effective. There are constraints that hamper the response process, such as not being able to take a critical application offline to analyze the attack and having to sort through myriads of IDS data.

Honeypots offer solutions to these situations in that a honeypot can be taken offline to analyze data and prepare a response because the honeypot is not an application used on the network. Secondly, as stated previously, honeypots generate small amounts of data that are the direct result of an attack, so the data can be reviewed more efficiently and a response implemented in a shorter time period.

Honeypot categories

In general, there are two types of honeypots: low-interaction honeypots and high-interaction honeypots. In this context, *interaction* refers to the level of activity provided by the honeypot to the attacker.

Low-interaction honeypots

A low-interaction honeypot supports a limited emulation of an operating system and system services. Thus, a cracker's actions are limited by the low level of emulation that the honeypot provides. An obvious advantage of this type of honeypot is its lack of complexity and ease of deployment.

Because the honeypot has minimal capabilities, it also reduces the risk of an attacker compromising the honeypot to launch an attack on other network resources. Conversely, the simplicity of a low-interaction honeypot is one of its weaknesses, in that its limited interaction makes it easier for an attacker to determine that he or she is engaged with a honeypot. An example of a low-interaction honeypot is Honeyd, which is further discussed later in this chapter.

High-interaction honeypot

High-interaction honeypots are more complex than low-interaction honeypots in that they provide for more complex interactions with attackers by incorporating actual operating systems and services. This type of honeypot can capture a large amount of information about an attacker and his or her behavior. But, as a consequence of its use of actual operating systems, a high-interaction honeypot is susceptible to compromise and being used as a base to launch an attack against other network compo-

nents. Also, a high-interaction honeypot requires additional resources for deployment and maintenance. An example of this type of honeypot is the Symantec Decoy Server.

When to use a honeypot

As discussed earlier in this chapter, a honeypot is used in either a research or production mode. The research type of honeypot has high levels of interaction with an attacker and performs the following functions:

- ♦ Through a honeynet, it captures information on the behavior, intentions, characteristics, and identity of attackers. A *honeynet* is an architecture comprising a controlled network of high-interaction honeypots that are intended to be targets of attacks.
- ♦ It provides information on the activities of specific organizations and associated threats.
- ♦ It gathers data on attacks occurring globally (distributed research honeypots).

The production honeypot is designed to emulate an actual operating system and services on a computer system for the express purposes of identifying vulnerabilities and acquiring information that can be used to detect and apprehend attackers. Specifically, a production honeypot can do the following:

- ♦ Determine how an attacker gained access to the network
- ♦ Monitor the attack in real-time
- ♦ Indicate that an attack is occurring
- ♦ Isolate the attacker from the remainder of the network
- ♦ Acquire information about the attacker

When not to use a honeypot

Deploying a honeypot requires careful consideration of the legal issues involved with monitoring, gathering information on, and prosecuting an individual based on the use of a honeypot. Some of the legal concerns are as follows:

- ♦ The liability of your organization if your honeypot is used to attack another organization's network
- ♦ Privacy rights of individuals being monitored on your network
- ♦ The possibility that an attacker apprehended through the use of a honeypot will claim entrapment
- ♦ Relevant laws of different jurisdictions outside of the United States

Uniformed deployment and use of honeypots without legal advice can lead to civil and criminal penalties for violating an individual's privacy rights through illegal monitoring of his or her activities. For example, evidence obtained by an agent of the U.S. government or a private individual acting at the behest of an agent of the U.S. government can be in violation of the Fourth Amendment of the U.S. Constitution through illegal monitoring activities. The Fourth Amendment states, "The right of the people to be secure in their persons, houses, papers, and effects, against unreasonable searches and seizures, shall not be violated, and no Warrants shall issue, but upon probable cause, supported by Oath or affirmation, and particularly describing the place to be searched, and the persons or things to be seized." A private individual who is not acting as an agent of the U.S. government is not bound by the Fourth Amendment and can deploy a honeypot. However, that individual is still bound by state and federal privacy laws that might be applicable to monitoring of a person's communications.

Another legal consideration is the 1968 Federal Wiretap Act, which is sometimes referred to as Title III. This Act was expanded in 1986 and establishes procedures for court authorization of real-time surveillance of electronic communications. The types of activities for which wiretaps can be authorized were increased by the USA PATRIOT Act. Under certain circumstances, this Act provides privacy protections related to interception of communications that might be violated by use of a honeypot if precautions are not taken in advance.

An additional area of concern to an organization is if a honeypot is used to launch attacks on other networks or used as a repository for stolen information or illegal material.

Finally, an apprehended attacker might cry entrapment if he or she was caught as a result of a honeypot. A sympathetic judge might agree with that interpretation but, in most cases, the entrapment defense is weak in that the attacker has to illegally penetrate the security perimeter to get to the honeypot. Thus, the situation is more akin to enticement than entrapment, and enticement is not a legal violation.

Current solutions

Two specific examples of honeypot applications are the Honeyd honeypot and the HoneyNet Project.

Honeyd

Honeyd is a low-interaction, open-source honeypot developed by Niels Provos. Honeyd 0.8 was released under the GNU General Public License (GPL) in January of 2004. At his Honeyd Web site, (www.honeyd.org/), Provos states, "Honeyd is a small daemon that runs both on UNIX-like and Windows platforms. It is used to create multiple virtual honeypots on a single machine. Entire networks can be simulated using Honeyd. Honeyd can be configured to run a range of services like FTP, HTTP, or SMTP. Furthermore, a personality can be configured to simulate a certain

operating system. Honeyd allows a single host to claim as many as 65,536 IP addresses.” Honeyd operates in the following fashion:

1. It monitors connection attempts to unused IP space
2. It checks connections to ports such as TCP and UDP
3. It intercepts connections and pretends to be a system service or OS
4. It logs attacker’s interaction with the service or OS emulated by the honeypot
5. It captures information such as passwords, IDs, command instructions, and attack targets

Honeynet Project

The Honeynet Project was established in 1999 as a network security research activity using honeynets and honeypots to explore and discover a cracker’s behaviors, motives, tools, and approaches, and to apply the lessons acquired from this effort. During the first two years, the Honeynet research group was limited to 30 members. One of the members, Dr. Eric Cole, is a coauthor of this book. In 2002, the Honeynet Research Alliance was formed to include a larger number of contributors, including researchers from India, Mexico, Greece, Brazil, and Ireland. The team members volunteer their time and contribute hardware and software to the project.

The project evolved in the following four phases:

- ♦ **Phase I**— This phase was initiated in 1999 and served as a proof-of-concept effort to deploy and test first-generation (GenI) honeynet approaches.
- ♦ **Phase II**— Begun in 2002, the intent of this phase was to develop GenII honeynets with advanced monitoring techniques and improved methods to control attackers’ activities when interacting with the honeynet. Additional tasks included incorporating the ability to handle encrypted information and making honeynets easier to deploy.
- ♦ **Phase III**— The third phase began in 2003 and transported GenII honeynet technologies to bootable CD-ROM for ease of distribution and deployment.
- ♦ **Phase IV**— This 2004 activity is focused on developing user interfaces and a centralized data collection system to correlate information from distributed honeynets.

Incident Handling

One of the key drivers of incident handling is the organization’s information system security policy. This security policy defines the rules that regulate how an organization manages and protects computing resources to achieve security objectives.

Well-documented, communicated, and properly enforced intrusion detection policies and processes prepare the organization to respond to intrusions in a timely and controlled manner.

A networked system security policy should require that designated system and network administrators and response team members are trained in the use of intrusion response tools and environments. This training should include participation in response practice drills or simulations using the tools and environments.

Also, the security policy should require that the inventory of all applications software, operating systems, supporting tools, and hardware be kept up-to-date. It should mandate rapid accessibility to backups in an emergency, even if they are stored at a remote site. This requirement may include defining procedures that give specific managers the responsibility to authorize such access.

Often, the policy will state that staff members dealing with an intrusion may require access to restricted systems and data. This specification usually includes criteria for access, establishment of authority for access, and means for tracking and documenting access.

The critical issues associated with incident handling are as follows:

- ♦ Protecting the assets that could be compromised
- ♦ Protecting resources that could be utilized more profitably if an incident did not require their services
- ♦ Complying with (government or other) regulations
- ♦ Preventing the use of your systems in attacks against other systems (which could cause you to incur legal liability)
- ♦ Minimizing the potential for negative exposure

A number of organizations have developed and published best practices for incident handling. The recommendations of two of these organizations, the Carnegie Mellon University CERT Coordination Center (CERT/CC) and the Internet Engineering Task Force (IETF), are presented in the following sections.

CERT/CC practices

The CERT/CC recommended practices for handling incidents are as follows:

1. PREPARE
 - a. Establish policies and procedures for responding to intrusions.
 - b. Prepare to respond to intrusions.

2. HANDLE

- a. Analyze all available information to characterize an intrusion.
- b. Communicate with all parties that need to be made aware of an intrusion and its progress.
- c. Collect and protect information associated with an intrusion.
- d. Apply short-term solutions to contain an intrusion.
- e. Eliminate all means of intruder access.
- f. Return systems to normal operation.

3. FOLLOW UP

- a. Identify security lessons learned.
- b. Implement security lessons learned.

The following sections expand on these recommended actions.

Establish response policies and procedures

Response procedures describe how the response policies will be implemented throughout your organization (for example, who to notify, at what point in the response procedure, and with what types of information). From these procedures, all concerned parties are able to determine what operational steps they need to take to comply with your policies and, thereby, respond in a manner that upholds the security objectives for your organization's information and networked systems.

This practice describes a subset of the topics your intrusion response policies and procedures should address. Additional policy and procedure information is contained in the other practices of this module where it is most applicable. This language needs to be tailored to reflect the specific business objectives and security requirements of your organization and its computing environment. The details of procedures used to address specific types of intrusions may vary.

Establish guidelines and rules at the management level for responding to intrusions and include these in your organization's networked systems security policy.

- ♦ Document your configuration redundancy policy.
- ♦ Document a response procedure that implements your intrusion response policies.
- ♦ Conduct a legal review of your policies and procedures.
- ♦ Train designated staff about your response policies and procedures.

Prepare to respond to intrusions

Preparation includes selecting, installing, and becoming familiar with tools that will assist you in the response process and will help you collect and maintain data related to an intrusion. You need to perform the following preparatory steps well in advance of an intrusion:

- ♦ Build an archive of boot disks and distribution media for all applications and all operating systems and versions.
- ♦ Build an archive of security-related patches for all applications and all operating systems and versions.
- ♦ Identify and install tools that support the reinstallation of systems, applications, and patches.
- ♦ Ensure that your backup procedures are adequate to recover from any damage.
- ♦ Build an archive of test results that describe the expected state of your systems.
- ♦ Ensure that high-capacity, removable, and write-protected media and supporting equipment are available to make and restore system backups.
- ♦ Build and maintain a database of contact information.
- ♦ Set up secure communication mechanisms.
- ♦ Identify and install tools to access directories and other sources of contact information.
- ♦ Build a resource kit of tools and hardware devices.
- ♦ Ensure that test systems and networks are properly configured and available.

Analyze all available information

After you have been alerted by your intrusion detection mechanisms or another trusted site that an intrusion has been detected, you need to determine to what extent your systems and data have been compromised and you need to respond. Information, as collected and interpreted through analysis, is key to your decisions and actions throughout the response process.

Your goal is to determine the following:

- ♦ What attacks were used to gain access
- ♦ What systems and data an intruder did access
- ♦ What an intruder did after obtaining access
- ♦ What an intruder is currently doing when an intrusion has not been contained or eliminated

The analysis process entails the following:

- ♦ Back up the compromised systems.
- ♦ Isolate the compromised systems.
- ♦ Search on other systems for signs of intrusion.
- ♦ Examine logs generated by firewalls, network monitors, and routers.
- ♦ Identify the attacks used to gain access to your systems.
- ♦ Identify what an intruder did while accessing your systems.

Communicate with all parties

Those with key roles in responding to an intrusion need to be notified and kept informed at the appropriate times to fulfill their responsibilities. You need to notify immediately the responsible mid-level and senior managers, your local computer security incident response team (CSIRT), if one exists, your public relations staff, and the affected system administrators (if they are not already involved) based on your organization's information dissemination policy. Executing your information dissemination procedures may include contacting users affected by an intrusion, security personnel, law enforcement agencies, vendors, and other CSIRTs external to your organization.

- ♦ Execute your information dissemination procedures taking the specifics of an intrusion into account.
- ♦ Use secure communication mechanisms.
- ♦ Inform upstream and downstream sites of attacks and intrusions.
- ♦ Maintain a detailed contact log.
- ♦ Maintain current contact information for your systems and sites.

Collect and protect information

All information about the compromised system or systems and causes of an intrusion needs to be captured and securely stored. This may include system and network log files, network message traffic, user files, results produced by intrusion detection tools, analysis results, system administrator console logs and notes, and backup tapes that capture the before-intrusion and after-intrusion states of the affected system. All information must be carefully collected, labeled, cataloged, and securely stored at each stage of intrusion analysis.

- ♦ Collect all information related to an intrusion.
- ♦ Collect and preserve evidence securely.

- ♦ Preserve the chain of custody for all evidence.
- ♦ Contact law enforcement immediately if you decide to pursue and prosecute an intruder.

Apply short-term containment solutions

Containment consists of short-term, tactical actions whose purpose is to stop an intruder's access to compromised systems, limit the extent of an intrusion, and prevent an intruder from causing further damage.

- ♦ Temporarily shut down the compromised system.
- ♦ Disconnect the compromised system from a network.
- ♦ Disable access to compromised file systems that are shared with other computers.
- ♦ Disable system services, if possible.
- ♦ Change passwords or disable accounts.
- ♦ Monitor system and network activities.
- ♦ Verify that redundant systems and data have not been compromised.

Eliminate all means of intruder access

Complete eradication of the root cause(s) of an intrusion is a long-term goal that can only be achieved by implementing an ongoing security improvement process. In response to a specific intrusion, you need to ensure that the affected systems are protected against the same or similar types of access and attacks in the future, after an intrusion is contained and systems are returned to normal operation.

- ♦ Change all passwords on all systems to which the attacker may have had access.
- ♦ Reinstall compromised systems if your preparation was insufficient.
- ♦ Remove any means for intruder access, including changes made by an intruder.
- ♦ Restore executable programs (including application services) and binary files from original distribution media.
- ♦ Review system configurations.
- ♦ Determine if you have uncorrected system and network vulnerabilities and correct them.
- ♦ Improve protection mechanisms to limit the exposure of networks and systems.
- ♦ Improve detection mechanisms to enable better reporting of attacks.

Return systems to normal operation

Restoring and returning a compromised system to normal operation permits your staff to have access to that system again. This is best accomplished after all means of intruder access are eliminated. Doing so prevents the same or similar types of intrusions from occurring or, at the very least, ensures timely detection and notification by your updated intrusion detection mechanisms.

- ♦ Determine the requirements and timeframe for returning the system to normal operations.
- ♦ Enable system and application services.
- ♦ Restore user data from trusted backup media.
- ♦ Re-establish the availability of previously disconnected file systems.
- ♦ Reconnect the restored system to the network.
- ♦ Validate the restored system.
- ♦ Watch for additional scans or probes that may signal the return of an intruder.

Identify and implement security lessons learned

It is important to learn from the successful and unsuccessful actions taken in response to an intrusion. Capturing and disseminating what worked well and what did not will help reduce the likelihood of similar intrusions and will improve the security of your operation. This can be accomplished by performing a post-mortem review with all involved parties and then communicating the results of the review.

- ♦ If further notification is required (per policies and procedure), execute the notification.
- ♦ Manage ongoing press aspects of an intrusion, if any.
- ♦ Hold a post-mortem analysis and review meeting with all involved parties.
- ♦ Revise security plans, policies, procedures, and user and administrator training to prevent intrusion recurrence.
- ♦ Determine whether or not to perform a new risk analysis based on the severity and impact of an intrusion.
- ♦ Take a new inventory of your system and network assets.
- ♦ Participate in investigation and prosecution, if applicable.

Internet Engineering Task Force guidance

Additional guidance on incident handling is provided by the Internet Engineering Task Force (IETF) RFC 2196, *Site Security Handbook*. The handbook recommends the following approach to the handling of incidents:

1. Preparing and planning (what are the goals and objectives in handling an incident)
2. Notification (who should be contacted in the case of an incident)
 - Local managers and personnel
 - Law enforcement and investigative agencies
 - Computer security incidents–handling teams
 - Affected and involved sites
 - Internal communications
 - Public relations and press releases
3. Identifying an incident (is it an incident and how serious is it)
4. Handling (what should be done when an incident occurs)
 - Notification (who should be notified about the incident)
 - Protecting evidence and activity logs (what records should be kept from before, during, and after the incident)
 - Containment (how can the damage be limited)
 - Eradication (how to eliminate the reasons for the incident)
 - Recovery (how to reestablish service and systems)
 - Follow up (what actions should be taken after the incident)
5. Aftermath (what are the implications of past incidents)
6. Administrative response to incidents

Layered security and IDS

Computer security is most effective when multiple layers of security controls are used within an organization, and IDSs are best utilized when implemented using a *layered security* approach. This method specifies that multiple steps be taken to secure the data, thereby increasing the workload and time required for an intruder to penetrate the network. While a firewall is an excellent perimeter security device, it is only one element of an effective security strategy. The more elements, or layers, of security that can be added to protect the data, the more secure the infrastructure will remain.

Elements of an effective layered security approach include the following:

- ♦ Security policies, procedures, standards, and guidelines, including high-level security policy

- ♦ Perimeter security, such as routers, firewalls, and other edge devices
- ♦ Hardware or software host security products
- ♦ Auditing, monitoring, intrusion detection, and response

Each of these layers may be implemented independently of the others, yet are interdependent when functioning. An IDS that generates alerts to unauthorized access attempts or port scanning is useless without a response plan to react to the problem. Because each layer provides elements of protection, the defeat of any one layer should not lead to a complete failure of protection.

Computer Security and Incident Response Teams

Numerous Computer Security and Incident Response Teams (CSIRTs) have been organized to address the issues of coordination and communication in response to security incidents. Coordination includes the detection, prevention, and handling of security incidents; understanding the current state of security; and identifying trends in activity within their constituency. Because the Internet is a cooperative network, authority and responsibility for security is distributed across logical domains.

Table 17-1 shows some of the existing response teams in the government, military, university, and corporate sectors.

Table 17-1
CSIRTs

<i>Response Team</i>	<i>Constituency</i>
AUSCERT	Australia (sites in .au domain)
CERT © Coordination Center (CERT/CC)	The Internet
Cisco-PSIRT	Commercial Cisco customers
DFN-CERT	German sites
DOD-CERT	Department of Defense systems
Global Integrity (REACT)	Commercial and government customers
OSU-IRT	Ohio State University
OxCERT Oxford University IT Security Team	Oxford University
FedCIRC	U.S. Government
FIRST	INFOSEC Community at large

CERT/CC

As previously referenced, the CERT/CC is a unit of the Carnegie Mellon University Software Engineering Institute (SEI). SEI is a federally funded research and development center and CERT's mission is to alert the Internet community to vulnerabilities and attacks, and to conduct research and training in the areas of computer security, including incident response.

FedCIRC

The Federal Computer Incident Response Center (FedCIRC) is an organization that “establishes a collaborative partnership of computer incident response, security, and law enforcement professionals who work together to handle computer security incidents and to provide both proactive and reactive security services for the U.S. Federal government”. The FedCIRC charter states: “FedCIRC provides assistance and guidance in incident response and provides a centralized approach to incident handling across agency boundaries.” FedCIRC's mission is to do the following:

- ♦ Provide civil agencies with technical information, tools, methods, assistance, and guidance
- ♦ Be proactive and provide liaison activities and analytical support
- ♦ Encourage the development of quality products and services through collaborative relationships with federal civil agencies, the Department of Defense, academia, and private industry
- ♦ Promote the highest security profile for government information technology (IT) resources
- ♦ Promote incident response and handling procedural awareness with the federal government

FIRST

The Forum of Incident Response and Security Teams (FIRST) brings together a variety of computer security incident response teams from government, commercial, and academic organizations. FIRST aims to foster cooperation and coordination in incident prevention, to prompt rapid reaction to incidents, and to promote information sharing among members and the community at large.

FIRST's goals are as follows:

- ♦ To foster cooperation among information technology constituents in the effective prevention, detection, and recovery from computer security incidents
- ♦ To provide a means for the communication of alert and advisory information on potential threats and emerging incident situations

- ♦ To facilitate the actions and activities of the FIRST members including research and operational activities
- ♦ To facilitate the sharing of security-related information, tools, and techniques

Security Incident Notification Process

All potential, suspected, or known information security incidents should be reported to a CSIRT. The CSIRT will then assign personnel who will assemble all needed resources to handle the reported incident. The incident coordinator will make decisions as to the interpretation of policy, standards, and procedures when applied to the incident.

Law enforcement and investigative agencies will be notified, as needed and required, by the CSIRT. In the event of an incident that has legal consequences, it is important to establish contact with investigative agencies such as the FBI as soon as possible. Local law enforcement should also be informed as appropriate. Legal counsel should be notified of an incident as soon as it is reported. At a minimum, legal counsel should be involved to protect the legal and financial interests of your company.

The security incident notification process should provide some escalation mechanisms. To define such a mechanism, the CSIRT should create an internal classification scheme for incidents. Associated with each level of incident will be the appropriate procedures. The following list is an example of various levels of incidents.

- ♦ **Priority One** — Protect human life and people's safety; human life always has precedence over all other considerations.
- ♦ **Priority Two** — Protect restricted and internal data. Prevent exploitation of restricted systems, networks, or sites. Inform affected restricted sensitive systems, networks, or sites about penetrations that have already occurred while abiding by any applicable government regulations.
- ♦ **Priority Three** — Protect other data, including managerial, because loss of data is costly in terms of resources. Prevent exploitations of other systems, networks or sites and inform already affected systems, networks, or sites about successful penetrations.
- ♦ **Priority Four** — Prevent damage to systems (for example, loss or alteration of system files, damage to disk drives, and so on). Damage to systems can result in costly down time and recovery.
- ♦ **Priority Five** — Minimize disruption of computing resources (including processes). It is better in many cases to shut a system down or disconnect from a network than to risk damage to data or systems. Each data and system owner must evaluate the trade-off between shutting down and disconnecting, and staying up. This decision must be made prior to an incident occurring. There may

be service agreements in place that may require keeping the systems up even in light of further damage occurring. However, the damage and scope of an incident may be so extensive that service agreements may have to be overridden.

Automated notice and recovery mechanisms

Automated notice and recovery mechanisms can provide automated capabilities in one or more of the following areas: intruder prevention, intruder detection, and damage assessment. A number of automated intruder responses have been implemented as part of intrusion detection systems. Some responses may be active, such as terminating processes, closing connections, and disabling accounts. Other responses are passive, such as sending an e-mail to the system administrator.

Damage assessment is normally performed after an attack. A number of vulnerability scanning tools, such as Tiger, may be used to perform damage assessment. Other tools, such as Tripwire, were specifically developed to aid in damage assessment. At Texas A&M University, a prototype tool called the Automated Incident Response System (AIRS) was developed to perform damage control and damage assessment on individual hosts in a network.

In addition, host-based IDSs, which perform real-time activity monitoring, can maintain a suspicion level for each user as well as an overall suspicion level of the monitored host.

Although not absolutely required, the ability of host-based IDSs to cooperate and share information to track users as they connect to other monitored hosts is also important.

Automated notice and recovery is appealing because it does not require continuous human oversight, it can act more rapidly than humans, and it can be tailored to, and will consistently follow, specified policies. Common automated response capabilities include session logging, session termination, posting events on the event console, and alerting personnel through e-mail, paging, and other means. The architecture to collect incident information consists of four crucial components: a sensor, collector, backing store, and an analysis engine.

However, most IDSs require a human operator to be in the loop. Given the current maturity of IDS technology, the dangers of automated response are significant, and outweigh the preceding advantages. With the frequency of false positives that exists in the current generation of IDSs, the potential for inappropriate response to misdiagnosis is too high. In addition, automated response could be exploited by a perpetrator whose aim is to induce a denial-of-service attack by spoofing an attack from a legitimate user. Also, many intrusion detection tools provide some form of automated intruder response, but few security tools perform any automated recovery.

Summary

This chapter reviewed malicious code, such as viruses, Trojan horses, and worms, used by attackers to disrupt and compromise information systems. Attacks can take the form of DDoS assaults, social engineering, war dialing, and brute-force password guessing to gain unauthorized access to critical infrastructures and valuable intellectual property. Then, shifting to the target side of the equation, the chapter explored intrusion detection and response methodologies to counter the harmful activities of crackers. As an example of novel ideas in intrusion detection, the chapter provided an overview of honeypots and honeynets. These entities act as target decoys employed to ensnare malicious intruders and gather information that will thwart their efforts, characterize their behaviors, and lead to their apprehension.

The chapter concluded with best practices to handle and respond to incidents to counter aggressions against valuable computing and network resources.



Security Assessments, Testing, and Evaluation

Assurance is defined as the measure of confidence that the security features and architecture of an information system accurately mediate and enforce an organization's information system security policy. A number of different approaches and methodologies have been developed to evaluate assurance. These techniques range from formal methods to probing and testing a network for vulnerabilities. This chapter addresses the most prominent approaches for assurance evaluation and testing developed by government and private organizations.

Information Assurance Approaches and Methodologies

An effective means to assess information system assurance is to determine if an organization has the appropriate technical, administrative, and organizational processes in place to enforce the organization's security policy. This section explores some methodologies that employ the process approach and derivatives thereof.



In This Chapter

Understanding the Systems Security Engineering Capability Maturity Model

Discussing other assessment methodologies

Understanding certification and accreditation

Exploring penetration testing

Reviewing audit and monitoring procedures



The Systems Security Engineering Capability Maturity Model

The Systems Security Engineering Capability Maturity Model (SSE-CMM) is based on the principle that information system security is a result of having good system security engineering processes in place. It is based on the Systems Engineering Capability Maturity Model (SE-CMM) and is maintained by the International Systems Security Engineering Association (ISSEA) at www.issea.org. The SSE-CMM defines the dimensions of domain and capability, which are used to measure the capability of an organization to perform specific activities. The *domain* dimension consists of all the practices that collectively define security engineering. These practices are called *base practices* (BPs) and they are grouped into *process areas* (PAs). The *capability* dimension represents *Generic Practices* (GPs) that indicate process management and institutionalization capability.

The SSE-CMM specifies 11 security engineering PAs and 11 organizational and project-related PAs in the domain dimension. BPs are mandatory characteristics that must exist within an implemented security engineering process before an organization can claim satisfaction in a given PA. The 22 PAs of the SSE-CMM, divided into security engineering and organizational/project processes, are given in Tables 18-1 and 18-2, respectively.

Table 18-1
SSE-CMM Security Engineering Processes

<i>Process</i>	<i>Name</i>
PA01	Administer Security Controls
PA02	Assess Impact
PA03	Assess Security Risk
PA04	Assess Threat
PA05	Assess Vulnerability
PA06	Build Assurance Argument
PA07	Coordinate Security
PA08	Monitor Security Posture
PA09	Provide Security Input
PA10	Specify Security Needs
PA11	Verify and Validate Security

Table 18-2
SSE-CMM Project and Organizational Processes

<i>Process</i>	<i>Name</i>
PA12	Ensure Quality
PA13	Manage Configuration
PA14	Manage Project Risk
PA15	Monitor and Control Technical Effort
PA16	Plan Technical Effort
PA17	Define Organization's Systems Engineering Process
PA18	Improve Organization's Systems Engineering Process
PA19	Manage Product Line Evolution
PA20	Manage Systems Engineering Support Environment
PA21	Provide Ongoing Skills and Knowledge
PA22	Coordinate with Suppliers

The GPs are grouped in five levels of security engineering maturity. *Maturity* implies a potential for growth in capability and indicates both the richness of an organization's processes and the consistency with which they are applied throughout the organization. The five levels of GP maturity and their attributes are given in Table 18-3.

Table 18-3
SSE-CMM GP Maturity Levels

<i>Level</i>	<i>Maturity</i>
Level 1 – Performed Informally	1.1 BPs are performed
Level 2 – Planned and Tracked	2.1 Planning Performance, 2.2 Discipline Performance, 2.3 Verifying Performance, 2.4 Tracking Performance
Level 3 – Well Defined	3.1 Defining a Standard Process, 3.2 Perform the Defined Process, 3.3 Coordinate the Process
Level 4 – Quantitatively Controlled	4.1 Establishing Measurable Quality Goals, 4.2 Objectively Managing Performance
Level 5 – Continuously Improving	5.1 Improving Organizational Capability, 5.2 Improving Process Effectiveness

NSA Infosec Assessment Methodology

The Infosec Assessment Methodology (IAM) was developed by the NSA to evaluate an organization's security posture and combines a subset of the SSE-CMM with a specialized criticality matrix. The IAM is designed to be useful to INFOSEC assessment suppliers and consumers. As a reference point in understanding the IAM, the NSA defines the following levels of assessments, as summarized in Table 18-4.

Table 18-4
Levels of INFOSEC Assessment

Assessment Level	Activity
Level 1 – Cooperative	Non-intrusive baseline evaluation of the information system security posture of an automated system
Level 2 – Cooperative	"Hands-on" security systems evaluation
Level 3 – Usually non-cooperative	Red team assessment with penetration testing. A Red team plays the part of the opposition or attacker of an information system. The Red team thinks like an adversary and tries to expose weaknesses in a system. The Red team is usually a part of the development team and provides feedback and recommendations for improving proposed designs and implementations.

The IAM is a Level 1 type of assessment and is conducted in three phases: pre-assessment, onsite, and postassessment. The *preassessment phase* involves identifying the system and its boundaries and beginning to develop an assessment plan. Acquiring data and documentation, conducting interviews, and providing initial assessment results are accomplished in the *onsite* phase. Then, the *postassessment* phase provides a final analysis and delivers the resultant findings.

The principal tool used in the IAM is the organizational criticality matrix. In the matrix, the relevant automated systems are assigned impact attributes based on their importance to the organization and the effect a compromise would have on the confidentiality, integrity, and availability of information. Table 18-5 provides an example of an organizational criticality matrix for a healthcare institution.

Table 18-5
An Example IAM Organizational Criticality Matrix

<i>Subject</i>	<i>Confidentiality</i>	<i>Integrity</i>	<i>Availability</i>
Admissions	High	High	Medium
Emergency	Medium	High	High
Pharmacy	High	High	Medium

Operationally Critical Threat, Asset, and Vulnerability Evaluation

The Carnegie Mellon University Software Engineering Institute (SEI) has developed a self-guided assessment methodology called the Operationally Critical Threat, Asset, and Vulnerability Evaluation (OCTAVE). OCTAVE is conducted by identifying an entity's critical assets and corresponding threats, discovering and listing the vulnerabilities that are subject to exploitation by the threats, and developing safeguards against the identified threats to preserve the organization's mission of the organization.

Federal Information Technology Security Assessment Framework

The Federal Information Technology Security Assessment Framework (FITSAF) is a method that can be applied by U.S. government agencies to perform the following functions:

- ♦ Properly apply existing policy and guidance
- ♦ Evaluate the state of extant security programs relative to organizational policy
- ♦ Establish a target for improvement
- ♦ Assess security controls for critical information systems

FITSAF has five levels of security capability based on the SEI Capability Maturity Model (CMM), as shown in Table 18-6. Government agencies are expected to eventually achieve Level 5.

Table 18-6
FITSAF Capability Levels

Level	Capability
Level 1	1.1 Documented Security Policy
Level 2	2.1 Documented Procedures Based on Security Policy, 2.2 Documented Security Controls Based on Security Policy
Level 3	3.1 Procedures Implemented, 3.2 Security Controls Implemented
Level 4	4.1 Procedures Tested and Reviewed, 4.2 Controls Tested and Reviewed
Level 5	5.1 Integrated Procedures and Controls

Certification and Accreditation

The National Information Assurance Glossary, CNSS Instruction No. 4009, defines *certification* as a “comprehensive evaluation of the technical and nontechnical security safeguards of an information system (IS) to support the accreditation process that establishes the extent to which a particular design and implementation meets a set of specified security requirements.” It defines *accreditation* as a “formal declaration by a Designated Accrediting Authority (DAA) that an IS is approved to operate in a particular security mode at an acceptable level of risk, based on the implementation of an approved set of technical, managerial, and procedural safeguards.”

This section discusses two widely used certification and accreditation processes, as well as some other useful types:

- ♦ National Information Assurance Certification and Accreditation Process (NIACAP)
- ♦ DoD Information Technology Security Certification and Accreditation Process (DITSCAP)

The National Information Assurance Certification and Accreditation Process

The *NIACAP* is specified in the National Security Telecommunications and Information Systems Security Instruction (NSTISSI) No. 1000. The NIACAP supports the certification that an information system meets and maintains documented accreditation requirements throughout the system’s life cycle. An important document in the NIACAP is the *System Security Authorization Agreement* (SSAA). The

SSAA is an evolving, but binding agreement among the principals in the NIACAP process that defines the boundary of the system to be certified, documents the requirements for accreditation, describes the system security architecture, documents test plans and procedures, and becomes the baseline security document.

There are three types of NIACAP accreditation:

- ♦ **Type accreditation** — Evaluates an application or system that is distributed to a number of different locations
- ♦ **Site accreditation** — Evaluates the applications and systems at a specific, self-contained location
- ♦ **System accreditation** — Evaluates a major application or general support system

Four phases of NIACAP

To conduct an NIACAP, it is necessary to understand the IS, the business needs, the security requirements, and the resource costs. The intended outcome is to ensure compliance with SSAA, certify the IS, receive accreditation, and operate the system in conformance with the SSAA. These activities are conducted in four phases, as shown in Table 18-7.

Table 18-7
The Four Phases of NIACAP

<i>Phase</i>	<i>Activities</i>
1 – Definition	Understand the IS architecture and business environment; determine security requirements, estimate levels of effort, define the certification and accreditation boundary, and develop and approve final phase 1 version of SSAA.
2 – Verification	Verify evolving system compliance with information security and risk requirements specified in SSAA, refine the SSAA, conduct system development and integration, and conduct initial certification analysis in preparation for Phase 3 certification and accreditation.
3 – Validation	Continue refining SSAA, conduct certification evaluation of IS, provide resulting recommendation to DAA, and obtain certification and accreditation decision and results.
4 – Post Accreditation	Operate and maintain system in accordance with SSAA, maintain SSAA, perform periodic compliance validation, and implement change management.

To perform a security assessment and conduct the four phases of NIACAP, specific personnel roles are required. These roles and their duties are summarized in Table 18-8.

Table 18-8
NIACAP Roles and Functions

<i>Role</i>	<i>Function</i>
Program Manager	Responsible for ensuring that an acceptable level of risk is achieved based on integration of the appropriate security requirements; responsible for the IS throughout the system life cycle, including system performance, cost, and on time-performance.
Designated Approving (Accrediting) Authority (DAA), or Accreditor	Responsible for implementing security for the IS; determines the acceptable level of risk and oversees IS budget and operations as the government representative. The DAA can grant accreditation or interim approval to operate until all security safeguards are in place and functioning.
Certification Agent or Certifier	Conducts certification based on having appropriate technical expertise; determines acceptable levels of risks and makes accreditation recommendation to DAA.
User Representative	Identifies user requirements, responsible for proper and secure operation of IS; represents user interests throughout life cycle of IS.

The U.S. Department of Defense (DoD) requires certification and accreditation of its information systems and uses a process very similar to NIACAP. The DoD Information Technology Security Certification and Accreditation Process is discussed in the next section.

DoD Information Technology Security Certification and Accreditation Process

DoD Directive 5200.40, “DoD Information Technology Security Certification and Accreditation Process (DITSCAP),” defines the DITSCAP as the standard certification and accreditation process for the Department of Defense. This process assesses the impact of the IS operation on the Defense Information Infrastructure (DII) by evaluating the system architecture and mission.

DITSCAP is applicable to the following entities:

- ♦ Military departments
- ♦ Chairman of the Joint Chiefs of Staff

- ♦ Combatant commands
- ♦ Inspector General of the Department of Defense
- ♦ Office of the Secretary of Defense (OSD)
- ♦ Defense agencies
- ♦ DoD field activities
- ♦ DoD contractors and agents
- ♦ DoD organizations involved with the acquisition, operation, and sustainment of any DoD system that collects, stores, transmits, or processes unclassified or classified information.

The four phases of DITSCAP

The DITSCAP is composed of the same four phases as NIACAP: definition, verification, validation, and postaccreditation. The activities in these phases are essentially identical to those of the NIACAP.

The roles of personnel involved in the DITSCAP are similar, but not identical to those of the NIACAP. The DITSCAP personnel roles and their functions are given in Table 18-9.

Table 18-9
DITSCAP Roles and Functions

<i>Role</i>	<i>Function</i>
System Program Manager	Responsible for budget and engineering of a system; represents the maintenance or acquisition unit for the system; responsible for system performance.
Designated Approving (Accrediting) Authority (DAA), or Accreditor	Responsible for oversight of mission needs and system operations; determines system security needs; usually is the senior operations officer. The DAA can grant accreditation or interim approval to operate until all security safeguards are in place and functioning.
Certification Agent or Certifier	Conducts certification based on having appropriate technical expertise; determines acceptable levels of risks, and makes accreditation recommendation to DAA.
User Representative	Identifies user requirements, responsible for proper and secure operation of IS; represents user interests throughout life cycle of IS.

Federal Information Processing Standard 102

Federal Information Processing Standard (FIPS) 102, September 27, 1983, addresses setting up and conducting certification and accreditation activities. Its formal title is “The Guideline for Computer Security Certification and Accreditation.”

The guideline defines the following policies and procedures for certification and accreditation:

- ♦ A Senior Executive Officer should establish authority for the certification and accreditation program and allocate responsibilities.
- ♦ The Certification Program Manager should issue a program manual that includes the processes involved and covers the Program Manager’s responsibilities.

FIPS 102 defines the certification and accreditation roles as follows:

- ♦ A Senior Executive Officer that allocates responsibilities and issues the Program Directive
- ♦ A Certification Program Manager that initiates the certification of an application, approves the Application Certification Plan, develops and issues the Program Manual, assigns an Application Certification Manager, and maintains certification and accreditation records
- ♦ An Application Certification Manager that develops the Application Certification Plan, manages the security assessment, and produces the evaluation report
- ♦ A Security Evaluator that performs the security assessment required for the certification

FIPS 102 defines the following steps in conducting a certification and accreditation:

1. Planning
2. Data Collection
3. Basic Evaluation
4. Detailed Evaluation
5. Report of Findings
6. Accreditation

OMB Circular A-130

The U.S. government Office of Management and Budget (OMB) issued Circular A-130 to establish policies for managing government information systems. It applies to all IT-related entities of the executive branch of the U.S. government.

Circular A-130 was developed in accordance with the following acts:

- ♦ The Paperwork Reduction Act (PRA), as amended (44 U.S.C. Chapter 35)
- ♦ The Privacy Act, as amended (5 U.S.C. 552a)
- ♦ The Chief Financial Officers Act (31 U.S.C. 3512 et seq.)
- ♦ The Federal Property and Administrative Services Act, as amended (40 U.S.C. 759 and 487)
- ♦ The Computer Security Act (40 U.S.C. 759 note)
- ♦ The Budget and Accounting Act, as amended (31 U.S.C. Chapter 11)
- ♦ Executive Order No. 12046 of March 27, 1978
- ♦ Executive Order No. 12472 of April 3, 1984

In particular, the Paperwork Reduction Act requires that the Director of OMB perform the following functions:

- ♦ Oversee the development and use of information management principles, standards, and guidelines
- ♦ Develop and implement uniform and consistent information resources management policies
- ♦ Evaluate agency information resources management practices to determine their adequacy and efficiency
- ♦ Determine compliance of such practices with the policies, principles, standards, and guidelines promulgated by the Director of OMB

Relative to certification and accreditation, Appendix III of the Circular requires “accreditation for an information system to operate based on an assessment of management, operational, and technical controls. The security plan documents the security controls that are in place and are planned for future implementation.” Specifically, Section 8a(9), “Information Safeguards,” of Appendix III, directs that agencies protect government information in accordance with risk management and risk assessment techniques.

Appendix III also mandates a number of actions to be taken by government agencies regarding information security, including the following:

- ♦ Plan in an integrated manner for managing information throughout its life cycle
- ♦ Integrate planning for information systems with plans for resource allocation and use, including budgeting, acquisition, and use of information technology
- ♦ Train personnel in skills appropriate to management of information
- ♦ Protect government information commensurate with the risk and magnitude of harm that could result from the loss, misuse, or unauthorized access to or modification of such information
- ♦ Use voluntary standards and Federal Information Processing Standards where appropriate or required
- ♦ Consider the effects of the actions of the IT-related entities of the executive branch of the U.S. government on the privacy rights of individuals, and ensure that appropriate legal and technical safeguards are implemented

The National Institute of Standards and Technology Assessment Guidelines

The National Institute of Standards and Technology (NIST) is a rich source of information and guidelines for assessing the assurance of information systems. This information is provided in the form of NIST Special Publications (SP) and is available at the NIST Web site (www.nist.gov). Table 18-10 provides a listing of some of the more popular information assurance SPs.

Table 18-10
Some NIST Information Assurance Special Publications

<i>SP</i>	<i>Title</i>
800-14	Generally Accepted Principles and Practices for Securing Information Technology Systems
800-27	Engineering Principles for Information Technology Security (A Baseline for Achieving Security)
800-30	Risk Management Guide for Information Technology Systems
800-64	Assess Threat Security Considerations in the Information System Development Life Cycle

SP 800-14

NIST Special Publication 800-14 identifies 8 system security principles and 14 common IT security practices. The principles are based on the Organization for Economic Cooperation and Development (OECD) information system security guidelines. The system security principles of SP 800-14 are as follows:

- ♦ Computer security supports the mission of the organization.
- ♦ Computer security is an integral element of sound management.
- ♦ Computer security should be cost-effective.
- ♦ Systems owners have security responsibilities outside their own organizations.
- ♦ Computer security responsibilities and accountability should be made explicit.
- ♦ Computer security requires a comprehensive and integrated approach.
- ♦ Computer security should be periodically reassessed.
- ♦ Computer security is constrained by societal factors.

The 14 common SP 800-14 security practices are given in Table 18-11.

Table 18-11
NIST SP 800-14 Common Security Practices

<i>Practice</i>	<i>Activities</i>
1. Policy	Establish plans, procedures, and directives
2. Program Management	Centralized oversight and enforcement of computer security
3. Risk Management	Assess risk, reduce risk, and maintain acceptable risk level
4. Life Cycle Planning	Develop security plan, and maintain plan through system life cycle
5. Personnel/User Issues	Access control for users, managers, and implementers
6. Preparing for Contingencies and Disasters	Planning to ensure continuity of business operations after a disaster
7. Computer Security	Responding effectively to malicious code and intrusions Incident Handling
8. Awareness and Training	Coordinate security

Continued

Table 18-11 (continued)

<i>Practice</i>	<i>Activities</i>
9. Security Considerations in Computer Support and Operations	Applying information system security principles to job functions of system administrators and external system support operations
10. Physical and Environmental Security	Implementing physical and environmental controls
11. Identification and Authentication	Applying identification and authentication to assign access privileges to information system resources
12. Logical Access Control	Using technical mechanisms to limit access to information systems and to enforce the system security policy
13. Audit Trails	Logging system activity and enabling accountability, intrusion detection, and problem identification
14. Cryptography	Providing cryptographic protections for the confidentiality and integrity of information as well as electronic signatures

SP 800-27

This publication incorporates the principles and practices of SP 800-14 into 33 system-level engineering principles for information technology security (EP-ITS). SP 800-27 also maps these system-level principles into the *five system life cycle phases of initiation, development and acquisition, implementation, operation and maintenance, and disposal*.

SP 800-30

SP 800-30, the “Risk Management Guide for Information Technology Systems,” is compatible with Appendix III of OMB Circular A-130 and provides non-mandatory guidelines for reducing information system risk to an acceptable level. To quote SP 800-30, “This guide provides a foundation for the development of an effective risk management program, containing both the definitions and the practical guidance necessary for assessing and mitigating risks identified within IT systems.”

Risk management is necessary for an organization to accomplish its mission by securing and managing its IT resources in an effective manner. Risk management also supports the certification and accreditation of information systems.

Key personnel that have roles in risk management include the following:

- ♦ Senior management
- ♦ Chief information officer (CIO)
- ♦ System and information owners
- ♦ Business and functional managers
- ♦ Information system security officer (ISSO)
- ♦ IT security practitioners
- ♦ Security awareness trainers

NIST SP 800-30 defines risk as “a function of the likelihood of a given threat-source’s exercising a particular potential vulnerability, and the resulting impact of that adverse event on the organization.”

SP 800-30 defines risk management as having the following three components:

- ♦ Risk assessment
- ♦ Risk mitigation
- ♦ Risk evaluation and assessment

Risk assessment

Risk assessment comprises the following steps:

1. System characterization
2. Threat identification
3. Vulnerability identification
4. Control analysis
5. Likelihood determination
6. Impact analysis
7. Risk determination
8. Control recommendations
9. Results documentation

Risk mitigation

Risk mitigation prioritizes the recommended controls that result from the risk assessment activity. Controls are subject to cost-benefit analyses and are used to limit the risk to an acceptable level that enables accomplishment of the organization's mission. To mitigate risk, technical, management, and operating controls can be applied.

The following options are available for risk mitigation:

- ♦ Risk avoidance
- ♦ Risk assumption
- ♦ Risk limitation
- ♦ Risk transference
- ♦ Risk planning
- ♦ Research and development

Evaluation and assessment

Because an organization usually experiences changes in personnel, network architecture, and information systems, risk management is a continuous process that requires ongoing evaluation and assessment. OMB Circular A-130 mandates that risk assessments be conducted every three years for U.S. government agencies. However, risk assessment should be conducted as necessary, such as after major alterations to networks or computers.

Residual risk

Even after controls are in place as a result of the risk management process, some risk, *residual risk*, always remains. It is the DAA's responsibility to take into account the residual risk in the certification and accreditation process.

SP 800-64

NIST SP 800-64, "Security Considerations in the Information System Development Life Cycle" (SDLC), is a guideline for incorporating information systems security in the phases of the SDLC. Examples of security functions for each of the five phases of the SDLC are given in Table 18-12.

Table 18-12
Examples of Information Systems Security in the SDLC

<i>Initiation</i>	<i>Acquisition/ Development</i>	<i>Implementation</i>	<i>Operations/ Maintenance</i>	<i>Disposition</i>
Preliminary Risk Assessment	Risk Assessment	Inspection and Acceptance	Configuration Management and Control	Information Preservation
Security Categorization	Security Functional and Assurance Requirements Analysis	Security Control Integration	Continuous Monitoring	Media Sanitization
	Cost Considerations and Reporting	Security Certification		Hardware and Software Disposal
	Security Control Development	Security Accreditation		

NIST SP 800-64 provides guidelines for acquisition, which is involved with identifying a need for a product or services, acquiring the product or services, and completing the contract for the product or services. In the acquisition process, requests for proposal (RFPs) are published to solicit bids for a product or service. An *acquisition initiator* represents the relevant program office in compiling the IT-related requirements and preparing for issuance of the RFP. After proposals in response to the RFP are received, an acquisition technical evaluation is conducted to review the technical merit of the proposals.

Penetration Testing

A *penetration test* is designed to evaluate an information system's defense and discover weaknesses in the network and its resources. Penetration testing is sometimes called *ethical hacking* because, in some instances, the entity conducting the penetration test is employing techniques used by crackers. The difference is the ethical hacker is acquiring information about the network to improve its security as opposed to causing harm. A penetration test can determine how a system reacts to an attack, whether or not a system's defenses can be breached, and what information can be acquired from the system.

Table 18-13 summarizes the different phases involved with conducting a penetration test.

<i>Phase</i>	<i>Activities</i>
1. Discovery	Acquire and evaluate information relevant to the organization and systems to be tested.
2. Enumeration	Acquire IDs, versions of software installed, and information concerning the network to be tested.
3. Vulnerability mapping	Characterize the information system environment and identify its vulnerabilities.
4. Exploitation	Try to exploit the system vulnerabilities and gain access privileges to the target system. Care is taken not to cause harm to the system or its information.
5. Report generation	Produce an executive overview report for management that profiles the network security posture and results of remediation activities, and generate an IT technical report for IT staff that details threats to the network, corresponding vulnerabilities discovered during testing, and remediation recommendations.

Penetration tests can be classified in a number of ways. The most common categories of penetration tests are as follows:

- ♦ Internal
- ♦ External
- ♦ Null knowledge
- ♦ Partial knowledge
- ♦ Zero knowledge
- ♦ Closed box
- ♦ Open box

Internal penetration test

This type of penetration tests tries to complete the following activities while operating from inside the network perimeter:

- ♦ Obtain unauthorized connection and access to the network
- ♦ Determine the network architecture
- ♦ Identify the OS
- ♦ Identify OS vulnerabilities
- ♦ Obtain protected information from the network and its associated resources
- ♦ Evaluate response of any installed intrusion detection systems
- ♦ Determine if there are any unauthorized items connected to the network

External penetration test

An external penetration test attempts to obtain network information while operating outside of the network perimeter. The following types of actions are performed during this type of test:

- ♦ Determine the network OS
- ♦ Determine OS vulnerabilities
- ♦ Obtain unauthorized entry to the internal network
- ♦ Gather information about the internal network
- ♦ Obtain information stored on internal network resources
- ♦ Test the external intrusion detection system (IDS)
- ♦ Test the firewall

Full knowledge test

The full knowledge test assumes an attacker has extensive knowledge about the network and its operation, increasing the opportunity for a successful penetration of the network.

Partial knowledge test

This test assumes that the penetration testing team has knowledge of some specific vulnerabilities in the network. Thus, the penetration test would include attacks aimed at those vulnerabilities.

Zero knowledge test

As the name implies, the penetration test begins with no a priori knowledge of the network and its resources. Thus, information has to be gathered from any available sources to use in the testing process.

Closed-box test

The closed-box test assumes the testing personnel have no access to the internal IT system code.

Open-box test

For this test type, the testing team does have access to internal system code, such as code from open-source operating systems such as Linux.

Auditing and Monitoring

Auditing and monitoring procedures for networks are used to ensure that security controls are operating and providing effective protection for the information systems. An *audit* is a one-time or periodic event to evaluate security while *monitoring* refers to an ongoing activity that examines either the system or the users.

Auditing

Auditing is conducted by either a group internal to an organization or by third-party auditors. Third-party auditors are usually certified professionals such as CPAs or, in the information security field, Certified Information Assurance Auditors (CISAs). Internal auditors normally evaluate due care practices and compliance with standards, and recommend improvements in safeguards and controls.

Standards

The Information Systems Audit and Control Association (ISACA, at www.isaca.org) has developed standards and guidelines for auditing IT systems. Examples of some of the standard practices are given as follows:

- ♦ The audit function is sufficiently independent of the area being audited to permit objective completion of the audit.
- ♦ The information systems auditor must adhere to the Code of Professional Ethics of the ISACA.
- ♦ The information systems auditor must maintain technical competence through the appropriate continuing professional education.
- ♦ During the course of the audit, the information systems auditor obtains sufficient, reliable, relevant, and useful evidence to achieve the audit objectives effectively.
- ♦ The information systems auditor provides a report, in an appropriate form, to the intended recipients upon the completion of the audit work.

The audit process

A successful information systems audit comprises the following processes:

1. Plan the audit.
2. Determine the scope of the audit.
3. Determine the objectives of the audit.
4. Validate the audit objectives and plan with the stakeholders.
5. Plan for necessary resources.
6. Perform the planned tasks.
7. Document the audit procedures and results.
8. Validate the audit results.
9. Report audit results to stakeholders.
10. Obtain stakeholders' final approval.

Audit trails are logs of events that provide a history of occurrences in the IT system. They document these events and are used for tracing sources of intrusions, recording results of intrusions, and, in general, summarizing the history of activities that took place on a system. Audit trails enable the enforcement of individual accountability by reconstructing events.

Audit information comprises a history of transactions, including who processed the transaction, the date and time of the transition, where the transaction occurred, and related activities. An audit associated with information system security searches for the following:

- ♦ Internal and external attempts to gain unauthorized access to a system
- ♦ Patterns and history of accesses
- ♦ Unauthorized privileges granted to users
- ♦ Occurrences of intrusions and their resulting consequences

In addition, auditors evaluate contingency plans, development standards, transaction controls, and data library procedures.

Because of their importance, audit logs should be protected at the highest level of security in the information system.

Monitoring

Monitoring is an active, sometimes real-time process, which identifies and reports security events that might be harmful to the network and its components. Examples

of such events or situations include unauthorized network devices, unauthorized personal servers, and unprotected sharing of equipment. Examples of items monitored include LAN and Internet traffic, LAN protocols, inventories of network devices, and OS security functions.

Intrusion detection mechanisms, penetration testing, and violation processing are used to accomplish monitoring.

Intrusion detection (ID) is discussed in detail in Chapter 17 and is applied to detect and analyze intrusion attempts. By using threshold or *clipping levels*, below which activities are deemed benign, the amount of information that has to be analyzed can be reduced significantly.

Penetration testing, discussed in a previous section of this chapter, probes and tests a network's defenses to determine the state of an organization's information security. Penetration testing can employ scanners, war dialers, protocol analyzers, and social engineering to determine the security posture of that organization.

Violation analysis uses clipping levels to detect potentially harmful events. For example, clipping levels can detect excessive numbers of personnel with unrestricted access to the system, personnel exceeding their authorization privileges, and repetitive mistakes.

Monitoring responsibility in an organization usually falls under the CIO or equivalent officer.

Summary

Ensuring that network security controls are cost effective and provide the required level of protection is the function of assurance evaluation mechanisms. Process models, such as the SSE-CMM and IAM, can evaluate assurance while the DITSCAP and NIACAP effectively certify and accredit information systems for operation.

The NIST SPs provide valuable guidelines for self-assessment and risk management and are complemented by auditing, monitoring, and penetration testing techniques.



Putting Everything Together

This book discusses all of the critical areas of network security. However, in a real environment it is not the individual components that will make you secure, but the integration of all of the components together. This chapter looks at network security from a more holistic viewpoint, looking at strategies that can be implemented and common problems and how they can be avoided.

Critical Problems Facing Organizations

On the surface, security seems like an easy problem to address; however, those of us who have worked in this area for a long period of time know it is anything but easy. Network security is very difficult to implement because in solving one problem you could introduce five new problems. Unexpected pitfalls can await you around each corner. This section looks at critical problems facing a network security professional and what can be done to avoid or minimize the impact these problems can have.

How do I convince management security is a problem and that they should spend money on it?

Selling security to upper management to get the proper budget can be a difficult problem. The fundamental miscalculation that many security professionals make is they assume

19

CHAPTER



In This Chapter

Understanding critical problems organizations face

Top issues in network security

Coming up with an organizational plan for network security



that management and upper-level executives understand security and how bad the problem is. I was recently leading a round-table discussion that was attended by Fortune 1000 executives. I started off by asking how many of them felt that their organizations have had more than 100 attempted intrusions over the last 6 months. None of them raised their hands. A couple executives said that there might have been one or two, but definitely not a number that was in the double digits. I was shocked and amazed by that answer, especially when I knew that several organizations had 400 to 500 attempted intrusions a week occurring. The executives clearly did not know or understand the reality of the situation at their organizations.

Now some people retort that it is not the executives' job to understand and know the specifics of network security problems; that is why they hire us. While that is true at a detailed level (they do not need to understand configuration issues), they should have a high-level understanding of what and how bad the problem really is.

In most organizations where people are having a hard time convincing management there is a problem it is usually because the security professionals have not given them any information on what is really happening. I know many organizations that are so concerned about presenting any bad information to executives that the security team will paint a rosy picture of how perfect everything is. Taking this approach is very dangerous because giving executives a false impression will only make things worse for you in the long run. In most cases, convincing management there is a problem is so difficult because the only information they have to go on is positive information.

What I recommend in terms of helping management understand there is a problem is that you provide high-level graphs of the number of attempted attacks that are occurring against your organization each week. I would also recommend speaking their language in terms of attacks. Instead of talking about firewalls and intrusion detection systems, talk the language of executives: dollars and cents. If you go to management and say, "We need to buy a new firewall because there was an increase in NetBIOS attacks," that means nothing to them. However, if you say, "We have a risk that cost us \$300k, it has an 80 percent chance of occurring again, and we need \$40k to prevent it," that is something an executive can understand and make a decision on. Spending \$40k to prevent a \$300k loss that could occur multiple times is a good return on investment (ROI), and if they have clear data to understand this is a real threat, chances are they will spend the money to fix it.

Note

Potential risks are assigned value based on how much damage they do. This allows you to be proactive in your response and fixed problems before they turn into breaches.

How do I keep up with the increased number of attacks?

This is a difficult problem because to keep up with the increase number of attacks you need to change your security role from reactive to proactive. However, if there are so many attacks that you are constantly being reactive, how can you ever find time to be proactive? This is one of those vicious cycles that you just have to address. In most cases, you have to slowly peel off time to fix security problems before there is an issue, not after. In addition, if you have a limited staff, security might be more of an advisory role where you work with and task other organizations to fix security problems proactively, while you still play a reactive role.

The more you do, the easier your job becomes. If you harden a server by turning off services and closing ports, it is now more secure. In making it more secure, you have actually made your job easier because now there are fewer things for an attacker to use to break in; therefore, you will have fewer attacks and be required to spend less time fixing breaches across your organization.

To get to a better end state, you have to have a plan for what you want to do. Figure out the critical problems and come up with a phased network design that will limit your exposure and increase your organization's security. Redesigning an entire network can be very time consuming, but you can slowly move critical servers to a different segment, harden those servers, and run automated auditing scripts that will only notify you if there is a problem. Now your systems can stay secure without your having to put in a lot of effort.

How do you make employees part of the solution and not part of the problem?

Like it or not, no matter how well a network is designed, employees or users will always be a necessary evil. They will either be part of the security problem or part of the solution. Frequently, how you treat them and educate them will dictate their behavior. One way to deal with them is through fear, historically an excellent motivator. However, this usually creates an adversarial role, which might give short-term benefits but long-term headaches. This is usually not recommended, except in extreme circumstances.

A better approach is to first design the network and the employees' systems in a way that will minimize what they can do across the organization. You have to let an employee have the access they need to do their job, but too often we give them additional access that is not needed. A big problem for organizations is spyware, and

most of the systems that get infected with spyware should not have allowed the user to install any software. Most employees do not need to install software and allowing them to have this extra access can cause security problems. Understanding what employees need to do and setting up an environment that controls and limits their span of access greatly reduces the problems.

While designing systems to minimize access is important, employees must still be educated. Employees can always find a way around the system if they want to. Even though you will never impact all employees, educating employees still reaps a big benefit. Most employees want their company to be successful and want to do the right thing. The problem is they do not really understand why security is important and perceive security as just a nuisance. If you do it correctly, user awareness training can go a long way in educating employees on why security is important and what they can do to help resolve the problem.

How do you analyze all of the log data?

Incidents cause damage and monetary loss to an organization. An incident is like a fire; the earlier you catch it, the less damage it will cause. The longer you allow an incident to go undetected the more damage it will inflict and the more resources will be needed to fix it. An incident is composed of events, so to know whether you have an incident and to be able to detect it in a timely manner, you must have the events available to look at. An event is an entry in a log file, and capturing your logs and reviewing them on a regular basis is a critical aspect of proactive security.

The trick with log analysis is to automate as much as you can and only pull in humans for the minimal amount of analysis to see if there is a problem later on. Having a list of set queries that will look for unusual or suspicious events helps. Then, instead of having to look through 50 pages of logs, you have to review only a small subset that has the critical information you need to make a decision.

Another strategy that works very well is to create scripts using tools such as `grep`, which will go through the logs and put all critical entries into different bins. For example, anything involving the Web goes into one bin, anything involving SMTP goes into another. Then within the Web bin, anything involving logons goes into one bin and anything involving CGI access goes into another. In essence, you start off with one big bin and you divide into smaller bins. You take those smaller bins and continue to divide them until you arrive at bins with a small enough number of entries that you can use that information to quickly make an analytical decision.

How do I keep up with all of the different systems across my enterprise and make sure they are all secure?

Rome was not built in a day, and a company cannot be secured in a day. Not every system across your organization is equal in importance; some are more critical than others. Going by your disaster recovery plan, one system or business process is going to be the highest priority for your organization and restored first. Therefore, having a prioritized list of systems helps you focus in on which systems are the most important, and those systems should also be the most secure. Then you can incrementally work down the list fixing the next highest priority system.

While this strategy seems to work, it does not always scale very well. Creating a secure baseline installation is another approach that works well. Every new system that gets rolled out is built from a security baseline that has been tested and is known to be secure. Now, instead of each administrator securing a system in a different manner and getting mixed results, every system is secure from the beginning. Then strict change control procedures need to be put in place to approve any changes that are made later so the system does not start off secure and deteriorate over time because no one is monitoring or controlling what changes are being made to it.

While this previous strategy works for new systems that are being rolled out, what about existing systems? It does not make practical sense to go in and rebuild existing systems. This would take too long and could be a troubleshooting nightmare if existing applications stop working. So, in the case of securing existing systems, hardening scripts work very well. The trick is to do incremental hardening and incremental rollout. Instead of going in and applying a script to all systems, you would take a small subset of the script and apply it to one box and see if there is any impact. If there is an impact, you can roll it back. If there is no impact, you can apply it to the next system. While this approach takes longer, it is much safer than an across-the-board rollout. If you go in and apply a robust script to all of your systems and the systems crash, you have a major problem on your hand. If you apply a small portion to one system and it crashes, you can easily recover from that.

How do I know if I am a target of corporate espionage or some other threat?

People often ask me whether their company is a target for attack or corporate espionage. The short answer is *yes*. Every organization, whether it is commercial, not for profit, or government, has something of value that it needs to protect. If an organization had nothing valuable or unique that it needed to protect, why would it exist?

In an organization having something of value, there are always going to be people that are going to want to gain access to that information or compromise it. Therefore, protecting that information is critical.

Even though network security is still not very robust in many organizations, trying to find and compromise data across the Internet can still be difficult. In many cases, especially with organizations that carefully protect their trade secrets, the easiest way to compromise a piece of information is by getting a trusted insider who works at the company. Employees have access to critical data and, if someone wants to compromise that data, it is much easier to compromise an individual and let the individual compromise the data on your behalf. Corporate espionage is a real threat and it is occurring all around us. However, because it is being committed by trusted insiders, many companies do not even know it is occurring. Those who know it is occurring rarely publicize it, and that's one reason why most people do not believe it is a problem — they never hear about it in the news. Every company is a target of corporate espionage and insider threat and you need to build your security posture to address this threat.

Besides the preceding threats, anyone connected to the Internet is a potential target of attack. There are worms, viruses, and attackers that just want to compromise computers so they can get access to the resources; they often do not really care about the data. In this particular case, your data is not at risk, but, if your systems and networks are compromised, it could affect business operations and still cause monetary loss across your organization.

Top 10 common mistakes

Because the title of this book is *Network Security Bible*, it is only appropriate to have the 10 commandments of network security. Actually, these commandments are written in the form of 10 common security mistakes that you want to avoid.

- 1. Presuming that one line of defense is adequate** — There is no silver bullet when it comes to network security. The only way that you are going to be secure is by having multiple lines of defense. A good network architecture starts with many layers, where each layer addresses a different threat.
- 2. Insufficiently understanding the technology and its nuances, including the many approaches a hacker can take to attack you** — Knowledge is power and ignorance is deadly. Only by understanding the offense and the capabilities they possess will you be able to build a robust, defensive posture. Too many organizations build security that does not address the true threat and, therefore, it is ineffective at securing an organization.
- 3. Thinking enablement, as opposed to disablement** — When your approach to an organization's security is trying to prevent employees or users from doing things, chances of success are much lower. However, when your approach to

security is an enabler and as a way to allow people to be successful, selling security across the organization becomes much easier. Remember, in general, if you tell someone they cannot do something (even if they do not need to do it), they will show resistance. However, if you tell people what they can do, they are usually more enthusiastic to help.

4. **Forgetting that security is part of a life cycle**—Security is not an afterthought or an add-on. Security must be designed into an organization and as an ongoing process. Just because you are secure today does not mean you will be secure tomorrow. Because organizations are constantly changing, security must also adapt and be an ongoing life cycle as opposed to a one-time task.
5. **Overlooking the physical aspects of security**—Buildings, rooms, data centers, physical computer access, and so on must be taken into consideration. An organization is only as strong as its weakest link. Preventing network security breaches means paying attention to the importance of strong physical and personal security.
6. **Relying on excessively weak trust or authentication mechanisms**—Authentication and validating who is allowed to do what across your organization is paramount. In many organizations, authentication is the first and only line of defense, so if it can be bypassed through weak authentication, security of the enterprise is at risk.
7. **Failing to understand exposure to attacks on information and infrastructure**—Security goes beyond having a firewall or intrusion detection systems. Security means knowing where your exposure points are, prioritizing them, and fixing them in a timely manner.
8. **Failing to understand and address the relationships between network, application, and operating system security**—Just because all of the single pieces of an organization are secure does not mean that when you put the pieces together the overall system will be secure. You must not only verify the individual components but also the comprehensive systems as a whole.
9. **Architecting a system that issues too many false alarms**—Unfortunately, there is usually a tradeoff between false positives (system giving an alert when it should not) and false negatives (system not giving an alert when it should). Because false negatives represent a breach, most systems are designed to err on the side of false positives; however, neither option is good and both should be reduced.
10. **Inadequately addressing the risk of security breaches from those within your organization**—Most networks are designed to prevent attacks from occurring from the Internet. While this is an important vector, insider threat and attacks are just as critical. It is important that organizations understand all potential threats and address them accordingly.

General Tips for Protecting a Site

This book has covered a wide range of network security issues and concepts. This section summarizes six key points that must be covered to have a proper level of security. No matter how large or small your organization is, these tips are critical to having a secure infrastructure:

- ♦ Defense in depth
- ♦ Principle of least privilege
- ♦ Know what is running on your system
- ♦ Prevention is ideal but detection is a must
- ♦ Apply and test patches
- ♦ Regular checks of systems

Defense in depth

When it comes to security, everyone is looking for the one technology that will solve all of a company's security problems. Sadly, it does not exist. Like anything in life, there is no free lunch; if you want to achieve a goal, you have to work hard and make a lot of sacrifices. Security is no exception. Companies are not only going to have to spend money, but invest in people and resources to have a secure enterprise. The more protection measures a company has in place the better, and this is the fundamental concept of the principle of defense in depth. A company must have multiple measures in place to secure their organization. As previously mentioned in Chapter 10, a very good example of defense in depth is medieval castles. The people that designed and built those castles knew a thing or two about defense in depth and incorporated a number of protection measures into the castle:

- ♦ Castles are always built on a hill so it makes it more difficult for someone to attack. It also makes it easier to see if someone is trying to attack you.
- ♦ At the bottom of the hill is a stone fence usually only a couple of feet high. This fence is not meant to stop the attackers but to slow them down.
- ♦ Around the castle is a moat, which also makes it more difficult for someone to gain access.
- ♦ At periodic intervals around the perimeter there are fortified towers, where defenders of the castle cannot only be on the lookout, but also be in a better position to fight back.
- ♦ There is only one way in and one way out of the castle. Having a single point of entry makes it easier to defend. You do not have to spread out your resources and defend four different areas; you can concentrate all of your resources in one area.

The builders realized that any single measures could be defeated but by putting several measures together you achieve a much higher level of security. The goal was ideally to prevent attack, but in cases where they couldn't be prevented, enough measures were put in place so that attackers were detected before they gained full access.

This same principle should be used when building a company's network security. So many companies install a firewall and think they are secure. A firewall is a good starting point, but you must combine firewalls with intrusion detection systems, host-based protection, encryption, and any new technologies that come along.

Employing multiple defensive measures is key; another key measure is to give entities (which can be users or computers) the minimum amount of access needed to do their jobs. This is called principle of least privilege and is discussed in the next section.

Principle of least privilege

Whenever anyone or anything is given more access than they need the potential for abuse increases. When it comes to security, people and programs should only be given the least amount of access needed to perform their jobs and nothing else. This is the foundation for the principle of least privilege. I consulted for one company where everyone who worked in IT had domain administrator access. When I questioned people about this their response was, "Because someone might need that access at some point, we figured it was better that they have it than have to ask for it later." In this case, the company was adhering to a principle of most privilege, giving users the most access they would ever need, and they wondered why they had so many security issues. Users will always want more access than they need to do their jobs. The way I get around this is instead of having users tell me what access they need, I have them tell me what job functions they need to perform. Based on those functions, appropriate access can be provided to them.

From an application or software standpoint, this can be a bigger problem. If an application is running as root and an attacker can compromise the program, they immediately have root access to the system. All applications should be reviewed to see what access they require to run correctly and be given the least amount of access necessary. Limiting the access that both users and applications have to a network will go a long way to protecting it from potential abuse. Of course, to limit access to applications and software, you must be aware of exactly what is running on your systems.

Know what is running on your system

The only way that you can secure your systems and network is if you know what is running on them. Things that you must be aware of are operating systems versions and patch levels, applications and version, open ports, and so on. An attacker is

most likely going to compromise your system by taking advantage of an open port or a vulnerability in the software that you are running. If you do not know what is running on your system, you will not be in a position to protect and defend against these types of attacks.

So many companies install servers and run applications but have no idea what is actually running on their system. A common way that attackers break into a system is by compromising test or sample scripts that were automatically installed on a system when the software was installed. In most cases, the company did not know the software was present on their system.

If you know what is running on your systems, including key systems, you will be able to decrease the number of successful attacks against your system. Even with strong security, an attacker will still potentially be able to penetrate your defenses; in those cases you need to be able to detect the attack as soon as possible.

Prevention is ideal but detection is a must

Ideally, a company would like to set up their security so to prevent all attacks. If this were possible, a company would set up their security once and be done with it. Unfortunately, not only does security constantly change, but as soon as a company connects to the Internet, preventing every single attack becomes impossible. There will always be some attacks that sneak through. This is true mainly because a company connects to the Internet to provide additional functionality to the company and their employees. As long as legitimate traffic needs to flow in and out of the company, other traffic will be able to sneak in. The only way a company could come close to preventing all attacks is if they deny all inbound and outbound traffic, and doing so defeats the purpose of connecting to the Internet. When it comes to functionality versus security, functionality always wins. Hopefully, as awareness increases, a better balance will be struck and the importance of security will be properly weighed.

Because a company cannot prevent all attacks, when an attacker does sneak into a network, the company must be able to detect it. If an attacker can gain access to a network and the company is not able to detect him, the attacker will have full access to the entire network. The sooner a company can detect an attack, the less overall damage the attacker will cause. A strong perimeter is a good starting part, but having mechanisms in place for early detection and warning is key.

Not only is detection key, but if a company increases the security of their hosts by applying the latest security patches, they can decrease the chance of a potential compromise.

Apply and test patches

New exploits are discovered on a regular basis. In most cases, they take advantage of an error in the underlying operating system or application. Therefore, the only way to protect against these exploits is to apply the appropriate patch from the corresponding vendor. Most vendors have special areas of their Web site where they post known security vulnerabilities in their software and where they make the patch to fix the problem available. You need to find these Web sites and review them on a regular basis. When a new patch comes out you can apply it before an attacker breaks in. A key thing to remember is that if a vendor acknowledges a vulnerability, you can assume that all of the attackers also know about it. Every day that passes without your system being patched is an open invitation for an attacker to compromise your system. Also, not only should patches be applied on a regular basis, but they should also be tested before they are loaded on an operational system. Just because a vendor releases a patch does not mean that when you load it on your system the system will continue to work properly. The only way to guarantee this is to test every patch on a test server before applying it to your production servers.

The fact that new patches are released all the time means that new vulnerabilities are being discovered constantly. So just because a system is secure today does not mean it will be secure tomorrow. A company's security is constantly changing, and to keep up with it, checks of the system must be done on a regular basis.

Regular checks of systems

In a company environment, new systems are always being added, new applications are being loaded, and older applications are being removed. To maintain a secure environment, systems must be scanned on a regular basis looking for any unusual changes. For example, if new user accounts appear or new ports are open, this could indicate either an attempted or successful compromise. Security is not something you set up once and forget about; it must be constantly reviewed and updated.

Summary

Hopefully, if this book has done nothing else, it has increased your awareness of the threats that exist and has shown you what can be done to protect against them. When it comes to network security and protecting your site, ignorance is deadly and knowledge is power. You should now have the knowledge to secure your company's assets and resources. Understanding what a company is up against is the only way to defend its network and systems from attackers.



Index

SYMBOLS AND NUMERICS

- * (asterisks) for password entry, 344
- 1G wireless systems, 386–387
- 2G wireless systems, 386
- 3G wireless systems, 386, 387
- 802.11 wireless security. *See* wireless security
- 802.11i wireless security standard
 - additional capabilities, 413
 - AES application in, 412–413
 - AES CBC mode, 409, 410–411
 - AES CTR mode, 409–410
 - AES MIC generation, 411–412
 - keys, 408–409
- 802.1X authentication, 402–403

A

- acceptability in biometrics, 71, 86
- access attacks, 559
- access control
 - centralized/decentralized, 84
 - content-dependent, 81
 - context-dependent, 81
 - databases for, 90–92
 - detective/administrative, 82–83
 - detective/physical, 83
 - detective/technical, 83
 - discretionary, 79–80
 - identification and authentication, 84–90
 - identity-based, 80
 - mandatory, 80
 - models, 79–81
 - non-discretionary, 81
 - overview, 95
 - preventive/administrative, 81
 - preventive/physical, 82
 - preventive/technical, 82
 - remote access, 93–95
 - role-based, 81
 - rule-based, 80
 - task-based, 81
 - terminology, 79
 - types of implementations, 81–84
- access control list (ACL), 80
- account harvesting, 266–267
- accountability, 5
- accounting
 - configuration status accounting, 58
 - remote access and, 93
- accreditation
 - defined, 14, 596
 - Designated Approving Authority and, 14
 - DITSCAP, 598–599

- FIPS 102 standard, 600
- NIACAP, 596–598
 - re-accreditation, 14
- ACL (access control list), 80
- acquisition/development phase of the SDLC. *See* development/acquisition phase of the SDLC
- active attacks
 - defined, 9
 - eavesdropping, 566
- active content
 - ActiveX controls for, 257–259
 - CGI scripts for, 252
 - client-side, 254–259
 - Java for, 255–257
 - JavaScript for, 254–255
 - PHP pages for, 254
 - server-side, 254–259
- ActiveX controls
 - defined, 226, 227
 - development of, 257
 - digitally signed, 227, 258–259
 - disabling, 227–228
 - Flash movie example, 258
 - OBJECT tag, 257–258
 - PARAM tag, 258
 - rotating X example, 259
 - security issues, 226, 227, 258–259
- ad hoc wireless mode, 398, 428
- Address Resolution Protocol (ARP)
 - cache, 427
 - defined, 373
 - message data structure, 427
 - overview, 426–427
 - packet filtering and, 431
 - spoofing, 282–284
- address-to-name resolution (reverse lookups), 316–318
- administrative controls
 - detective/administrative access control, 82–83
 - for physical security, 70, 72
 - preventive/administrative access control, 81
- administrative personnel controls, 71
- administrator account (Windows), 112, 130
- advanced mobile phone system (AMPS), 388, 391
- advisory policies, 45
- AES (Advanced Encryption Standard)
 - as block cipher, 465
 - Cipher-Block Chaining (CBC) mode, 409, 410–411
 - Counter (CTR) mode, 409–410
 - keys, 408–409
 - MIC generation, 411–412
 - performance, 468
- Affine Test, 526

- AH (Authentication Header), 545–546
- AIRS (Automated Incident Response System), 588
- AirSnort WEP-breaking program, 400
- AIX. *See* UNIX security
- algorithms
 - computationally secure, 461–462
 - gzip (GNU zip), 246
 - hash functions, 458, 471–473, 539
 - implementation versus, in cryptography, 475–476
 - mathematical attacks, 563
 - proprietary versus open source, in cryptography, 476–477
 - pseudorandom number generation, 457–458
 - for routing, 423
 - slow start (HTTP), 244, 245
 - for steganography, 480, 496–497
- Alpha Tec Ltd digital watermarking programs, 525
- America Online (AOL), 320–321, 363
- American National Standards Institute (ANSI) SQL standard, 267
- AMPS (advanced mobile phone system), 388, 391
- anacron service (UNIX), 178
- analyze all available information (CERT/CC practice), 580–581
- analyzing log data, 616
- Angstroms, 381
- anomaly, 440
- anomaly-based IDSs, 439–440, 568, 571
- anonymous FTP
 - minimizing risks, 360
 - misconfigurations, 359
 - security issues, 358–359
- ANSI (American National Standards Institute) SQL standard, 267
- antivirus software
 - configuring in Windows, 125
 - installing on Windows workstations, 116–118
 - intrusion detection and, 567–568
 - Microsoft recommendations, 103, 104
 - software exploitation and, 566
 - updates (signatures), 116, 139–140
 - virus prevention, 568
 - virus scanning, 567
- AOL (America Online), 320–321, 363
- apmd service (UNIX), 178
- APOP (Authenticated Post Office Protocol), 297–298
- Appletalk Session Protocol (ASP), 371
- Application layer (OSI)
 - overview, 368, 369
 - protocols, 369–370
 - proxy firewalls and, 433
- Application layer (TCP/IP), 377
- Application layer (WAP), 415
- apply short-term containment solutions (CERT/CC practice), 582
- architecture. *See also* network architecture
 - Design System Security Architecture process, 11, 15, 18, 20
 - DNS, 331–332
 - e-mail considerations, 302
 - layered, 367–378
 - VLAN, 425
 - Windows security and, 120–121
- ARP (Address Resolution Protocol)
 - cache, 427
 - defined, 373
 - message data structure, 427
 - overview, 426–427
 - packet filtering and, 431
 - spoofing, 282–284
- ARPANET, 309
- arpwatch service (UNIX), 178
- AS (Authentication Service) in Kerberos SSO, 87
- ASP (Appletalk Session Protocol), 371
- Assess Effectiveness process, 11, 21
- Assess Information Protection Effectiveness process
 - corresponding SE process, 11, 21
 - as part of all activities in the ISSE and SE processes, 17
 - tasks and corresponding ISSE activities, 18–19
- assessment. *See also* testing
 - of business impact, 60, 61–62
 - in risk management, 32, 42
 - of vulnerability, 61–62
- assurance. *See also* accreditation
 - defined, 591
 - Federal Information Technology Security Assessment Framework (FITSAF), 595–596
 - Infosec Assessment Methodology (IAM), 594–595
 - NIST assessment guidelines, 602–607
 - OMB Circular A-130, 601–602
 - Operationally Critical Threat, Asset, and Vulnerability Evaluation (OCTAVE), 595
 - Systems Security Engineering Capability Maturity Model (SSE-CMM), 592–593
- asterisks (*) for password entry, 344
- asymmetric encryption. *See also* PKI (Public Key Infrastructure); public key cryptography
 - cast of characters for examples, 460
 - Certificate Authority (CA) for, 468–469
 - digital signatures for, 470–471
 - hash functions for, 471
 - overview, 467–468
 - performance and, 468
 - web of trust for, 469–470, 541
- atd service (UNIX), 178
- attachments to e-mail
 - limiting, 303
 - operating safely and, 303
 - quarantining, 303
 - virus spread and, 116, 132–133, 146, 557
- attacks. *See also* DoS (denial of service); malicious code (malcode or malware)
 - access attacks, 559
 - account harvesting, 266–267
 - active, 9, 566
 - back door, 150–151, 435, 558, 560
 - birthday, 564–565

- brute-force, 448, 565
- close-in, 9
- common attacks, 442–443, 559–567
- cookie poisoning, 263
- defended by Defense-in-Depth, 8–9
- demon dialing, 567
- dictionary, 565
- distributed denial-of-service (DDoS), 75, 559–560
- distribution attacks, 9
- DNS, 326–328
- dumpster diving, 564
- eavesdropping, 204, 566, 264–265
- e-mail, 275–285
- fragmentation, 562
- graphing to convince management, 614
- hijacking, 152, 204, 216–217, 561
- inappropriate system use, 566
- increasing number of, 615
- insider, 9
- intrusions, 435
- man-in-the-middle, 204, 216, 281–284, 466–467, 561
- mathematical, 563
- modification attacks, 559
- overlapping fragment, 562
- passive attacks, 8–9, 566
- password guessing, 565
- ping-of-death, 560
- preparing for (UNIX), 164–165
- preparing for (Windows), 145
- replay attacks, 152, 204, 216, 217–218, 284–285, 533, 561
- repudiation attacks, 559
- scanning for vulnerabilities, 141, 157, 429, 440, 443, 564, 567
- smurf, 560
- social engineering, 75, 152–153, 563
- software exploitation, 565–566
- spam, 285–288, 440, 443
- spoofing, 282–284, 320–321, 327–328, 330, 429, 431, 560–561
- SQL injection, 267–268, 347–348
- SYN, 560
- TCP sequence number, 567
- teardrop, 560
- TEMPEST, 150
- tiny fragment, 562
- types described in IATF document 3.1, 8–9
- war dialing, 567
- war driving, 567
- weak keys, 562
 - on Web browsers, 216–219
 - on Web servers, 266–268
 - on Windows workstations, 145–153
- AuC (authentication center), 384
- AudioMark digital watermarking program (Alpha Tec Ltd), 525
- audit trails
 - defined, 24, 611
 - security issues for, 72
 - violation reports from, 83
- Audit-Guard IDS, 436
- auditing
 - configuration auditing, 58
 - described, 610
 - operating servers safely, 357–358
 - processes, 611
 - standards, 610
 - Windows security and, 144
- Authenticated Post Office Protocol (APOP), 297–298
- authentication. *See also* CIA properties
 - of ActiveX controls, 227, 258–259
 - APOP, 297–298
 - biometrics for, 71, 85–86
 - Callback method, 95
 - CHAP protocol, 94–95
 - client-server, 534–537
 - cryptography and, 456, 474
 - defined, 4, 84, 456, 538
 - e-mail, 294–295, 296–300, 530–533
 - GSSAPI, 300
 - IMAP and, 530
 - IPSec-based VPNs and, 544
 - Kerberos, 87–89, 299–300, 533
 - KryptoKnight system (IBM), 90
 - means for, 84
 - NTLM/SPA, 298–299
 - over Web browser sessions, 210–211
 - PAP protocol, 94
 - passwords for, 85
 - as PKI service, 538
 - poor, firewalls and, 429
 - POP, 294–295, 530
 - RADIUS service, 93
 - remote access and, 93–95
 - servers, 534
 - SESAME, 90
 - Single Sign-On (SSO), 86–90
 - SSH for, 118–119, 548
 - TACACS and TACACS+ protocols, 93–94
 - WEP weakness in, 400
 - WTLS, 415–416
- authentication center (AuC), 384
- Authentication Header (AH), 545–546
- authentication servers, 534
- Authentication Service (AS) in Kerberos SSO, 87
- authorization
 - defined, 5
 - faulty, account harvesting and, 267
 - remote access and, 93
 - reverse DNS lookups for, 317
- autocorrelation (index of coincidence), 451–452, 453
- autofs service (UNIX), 178
- Automated Incident Response System (AIRS), 588
- automated notice and recovery mechanisms, 588
- automatic update services (UNIX), 166
- AUTORUN, Windows security and, 111
- availability. *See also* CIA properties
 - backups and, 137
 - defined, 4

availability (*continued*)

- e-mail issues, 290
- example, 4
- as key principle, 3
- in network security, 4
- steganography and, 491

B

back door attacks, 150–151, 435, 558, 560

backup sites

- establishing, 65–66
- hot, warm, and cold sites, 65

backups

- e-mail security and, 303
- server security and, 356
- UNIX security and, 164–165
- Windows security and, 137

base practices (BPs) of SE-CMM, 592

base station, 384

base station controller (BSC), 384

base transceiver station (BTS), 384

baselines, 46

bastion host, 329

Bayesian logic, 288

BCPS stenographic technique, 514

biometrics

- for authentication, 85
- for identification, 85
- performance measures, 71, 86
- for physical security, 70, 71
- typical characteristics used for, 70, 86

BIOS control (UNIX), 161

birthday attacks, 564–565

blacklisting spammers, 287

block ciphers. *See also* AES (Advanced Encryption Standard)

- examples, 465
- modes, 464–465
- overview, 463–464

BlueSpike's Giovanni digital watermarking program, 525

Bluetooth, Haral (king of Denmark), 413

Bluetooth protocol, 413–414

Blum-Blum-Blum pseudorandom generator, 457, 458

bootable floppies, virus spread and, 116

booting

- boot-record infectors, 558
- UNIX security and, 161–162

BootP protocol

- defined, 370
- packet filtering and, 431

boot-record infectors, 558

BPs (base practices) of SE-CMM, 592

bridges

- as network segment boundaries, 418
- overview, 423

browser parasites, 218–219

brute-force attack, 448, 565

BSC (base station controller), 384

BTS (base transceiver station), 384

buffer overflows

- DoS attacks, 560
- programming languages and, 346

burstable TCP service, 250–251

Bush, Vannevar (hypertext conceiver), 247

business continuity plan

- approval and implementation, 60, 63
- defined, 59
- development, 60, 62
- initiation, 60–61
- scope of, 60

business continuity planning

- business impact assessment, 60, 61–62
- events impacting, 60
- goals and process, 60–63
- overview, 59
- plan approval and implementation, 60, 63
- plan development, 60, 62
- roles and responsibilities, 63–64
- scope and plan initiation, 60–61
- terminology, 59

business continuity planning committee, 63

business impact assessment

- conducting, 61–62
- defined, 60, 61
- goals, 61
- server security and, 339–340

business workstation security (Windows), 114

C

C and C++ languages, buffer overflows and, 345

CA (Certificate Authority)

- for asymmetric encryption, 468–469
- Certificate Revocation List (CRL), 540–541
- for Kerberos, 533
- PKI and, 540–541
- trusted signature introducers, 541

C&A. *See* accreditation

cable locks, 69

caching

- ARP, 427
- cache poisoning, 327–328, 330
- clearing the cache in Netscape, 231
- by Web browsers, 212

Callback authentication method, 95

Camouflage steganographic program, 516–517

Capability Maturity Model (CMM), 595–596

Card Holder Information Security Program (CISP), 222

cardinality, 91

carrier sense multiple access with collision avoidance (CSMA/CA) protocol, 398

CBC (cipher block chaining), 410–412, 464, 465, 468. *See also* AES (Advanced Encryption Standard)

CCB (Configuration Control Board), 58, 341–342

CDMA (Code Division Multiple Access)

- for IMT-2000, 389
- overview, 387
- spread spectrum technology, 393–397

CDMA2000 technology, 390

- CDPD (cellular digital packet data), 388, 392
- cell tower, 384
- cellular telephone network
 - components, 383–384
 - overview, 383–385
 - placing a call, 385–386
 - topology, 385
- centralized IDSs, 437, 438
- centralized/decentralized access control, 84
- CER (crossover error rate), 71, 86
- CERT/CC (CERT Coordination Center)
 - mail server, 302
 - response teams, 585, 586
- CERT/CC practices
 - analyze all available information, 580–581
 - apply short-term containment solutions, 582
 - collect and protect information, 581–582
 - communicate with all parties, 581
 - eliminate all means of intruder access, 582
 - establish response policies and procedures, 579
 - identify and implement security lessons learned, 583
 - overview, 578–579
 - prepare to respond to intrusions, 580
 - return systems to normal operation, 583
- Certificate Authority (CA)
 - for asymmetric encryption, 468–469
 - Certificate Revocation List (CRL), 540–541
 - for Kerberos, 533
 - PKI and, 540–541
 - trusted signature introducers, 541
- Certificate Revocation List (CRL), 540–541
- certificates
 - Kerberos, 532–533
 - SSL, 213–215, 550–552
 - TSIGs for, 323
 - UNIX security, 194–196
 - Windows security, 128–129
- certification
 - defined, 14, 596
 - DITSCAP, 598–599
 - FIPS 102 standard, 600
 - NIACAP, 596–598
 - recertification, 14
- CFB (cipher feedback), 464, 465
- CGI (Common Gateway Interface) scripts, 252
- “change cipher spec” message (SSL), 552
- CHAP (Challenge Handshake Authentication Protocol), 94–95
- chargen service (UNIX)
 - defined, 177
 - disabling, 355
- checking. *See also* monitoring
 - input to programs, 159, 346, 348–349
 - parameters for user accounts (Windows), 113
 - strong passwords (UNIX), 198–199
 - systems regularly, 623
- chief information officer (CIO), 34
- Chinese Remainder Theorem, 475
- chipping code, 395
- chkconfig command (UNIX), 185–186
- chmod command (UNIX), 190
- chroot command (UNIX), 192
- C-HTML (Compact HTML), 415
- CIA properties. *See also* authentication; availability; confidentiality; integrity
 - in cryptography, 456, 473–475
 - in network security, 3–4
- CIDR (classless interdomain routing), 425
- CIO (chief information officer), 34
- cipher block chaining (CBC). *See also* AES (Advanced Encryption Standard)
 - error propagation in, 464
 - for MIC generation, 411–412
 - performance, 468
 - popularity of, 465
 - steps in AES CBC mode, 410–411
- cipher feedback (CFB), 464, 465
- cipher text, 448
- ciphers. *See* cryptography
- CIRT (computer incident response team), 568
- CIs (configuration items)
 - defined, 57
 - hardening UNIX systems, 196–198
 - for Web browsers, 225–236
- Cisco Secure IDS, 435
- CISP (Card Holder Information Security Program), 222
- Classes A through E of IP addresses, 376–377
- classifying data, 131–132
- classless interdomain routing (CIDR), 425
- clients
 - client/server model, 248–249
 - client-side active content, 254–259
 - defined, 248
 - mail client configurations, 301
 - as principals in Kerberos authentication, 535
- client-server authentication
 - authentication servers, 534
 - in Kerberos, 535–537
- client/server model, 248–249
- clipping levels for audit trail reports, 83
- CLNP (Connectionless Network Protocol), 388
- closed-box penetration test, 610
- closed-circuit television, 68
- close-in attacks, 9
- cmdline file (UNIX), 173
- CMM (Capability Maturity Model), 595–596
- CNSS (Committee on National Security Systems), 12
- Codd, E. F. (relational model developer), 90
- Code Division Multiple Access (CDMA)
 - for IMT-2000, 389
 - overview, 387
 - spread spectrum technology, 393–397
- cold backup site, 65
- collaboration tools, 274
- collect and protect information (CERT/CC practice), 581–582
- collision-resistant one-way functions. *See* hash functions (hash codes)

- co-location of e-commerce, 270
- color tables and steganography, 501–502, 511–512
- comments, stripping from operational code, 345
- Committee on National Security Systems (CNSS), 12
- Common Gateway Interface (CGI) scripts, 252
- communicate with all parties (CERT/CC practice), 581
- Compact HTML (C-HTML), 415
- Company Sensitive data, 131
- compression in HTTP 1.1, 246
- “Compromising Emanations” (Kuhn, Markus G.), 72
- computationally secure cryptography, 461–462
- Computer Associates antivirus software, 103, 117
- computer crime
 - infamous crimes, 76
 - types of, 75
- computer incident response team (CIRT), 568
- Computer Security Act of 1987, 36
- Computer Security and Incident Response Teams (CSIRTs), 585–587
- concept of operations. *See* CONOPS
- confidentiality. *See also* CIA properties
 - cryptography and, 456, 473, 474
 - defined, 4, 456, 538
 - example, 3
 - IPSec-based VPNs and, 544
 - as key principle, 3
 - maintaining for e-mail, 288–289
 - in network security, 4
 - in PGP, 532
 - as PKI service, 538, 539
 - steganography and, 490
 - WEP weakness in, 400
- configuration auditing, 58
- configuration control. *See also* configuration management
 - digital certificate technology (Windows), 128–129
 - importance for Windows, 127–128
 - for installed packages (UNIX), 166–167
 - kernel-related issues (UNIX), 167–173
 - knowing the software on workstations (Windows), 129–130
 - overview, 57–58
 - for server security, 354–356
 - for UNIX workstations, 166
 - user account control (Windows), 128
 - for Windows workstations, 127–130
- Configuration Control Board (CCB), 58, 341–342
- configuration identification, 57
- configuration issues for Windows, 125–127
- configuration items (Cis)
 - defined, 57
 - hardening UNIX systems, 196–198
 - for Web browsers, 225–236
- configuration management. *See also* configuration control
 - configuration auditing, 58
 - configuration control, 57–58
 - configuration identification, 57
 - configuration status accounting, 58
 - defined, 56
 - documentation change control, 58–59
 - generally accepted procedures, 57
 - major components, 57
 - overview, 56
 - primary functions, 56–57
 - primary security goal of, 56
- configuration status accounting, 58
- confirmation, as PKI service, 538
- Connectionless Network Protocol (CLNP), 388
- connections
 - defined, 432
 - stateful packet-filtering and, 432
 - termination by IDSs, 442
- CONOPS (concept of operations)
 - Define System Security Requirements process and, 14
 - defined, 12
 - Develop Detailed Security Design process and, 16
 - Discover Information Protection Needs process and, 12
- consistency, internal versus external, 4
- Constitution (U.S.), 576
- Content settings (Internet Explorer), 235
- content-dependent access control, 81
- CONTENT_LENGTH environment variable, 252
- CONTENT_TYPE environment variable, 252
- context-dependent access control, 81
- contingency plan, 59
- continuity of operations plan, 59
- controlling processes (UNIX)
 - detecting services, 180–182
 - overview, 174–175
 - processes controlling processes, 183–187
 - services to avoid, 175–176
 - uncommon services, 178–179
 - useful services, 176–178
- controlling users for server security, 356
- controlling users (UNIX)
 - chroot command for, 192
 - file permissions, 188–190
 - overview, 187–188
 - root access, 192–194
 - setting the UID/GID flags, 190–191
- controls. *See also specific kinds*
 - analysis in risk assessment, 37
 - categories of, 41–42
 - configuration control, 57–58, 127–130, 166–173
 - documentation change control, 58–59
 - implementation of, 37
 - physical security, 68–72
 - preventive versus detective, 37
 - recommendations in risk assessment, 40
 - technical versus nontechnical, 37
- convenience versus security, 101
- cookies
 - authentication over sessions and, 209, 211
 - configuring Web browsers, 225–226
 - contents of, 208–209, 261
 - cookie poisoning, 263
 - cross-site scripting and, 346–347

- defined, 208
 - encrypting, 350
 - examples, 262
 - hijacking and, 217
 - Internet Explorer settings, 234
 - Netscape settings, 230–231
 - overview, 208–209
 - persistent data in, 131, 209
 - persistent versus nonpersistent, 209, 242
 - personal information and, 148–149, 209
 - privacy and, 148–149, 209, 263
 - Set-Cookie header, 261–262
 - storage locations, 263–264
 - tracking information for security, 356
 - for tracking state, 261–263
 - uses for, 261
 - cooperative agents, 438
 - copy protection. *See* digital watermarking
 - corporate espionage, 617–618
 - Counter (CTR) mode of AES, 409–410
 - country domain names, 311–315
 - covert channels
 - defined, 486
 - example, 486–487
 - steganography versus, 487
 - covert communication. *See* steganography
 - Crack password cracker (UNIX), 199
 - crackers, firewalls and, 429
 - critical problems for organizations
 - analyzing log data, 616
 - corporate espionage, 617–618
 - employee cooperation, 615–616
 - increasing number of attacks, 615
 - securing many different systems, 617
 - selling security to management, 613–614
 - top ten common mistakes, 618–619
 - Critical updates (Windows), 138
 - CRL (Certificate Revocation List), 540–541
 - crond service (UNIX), 178
 - crossover error rate (CER), 71, 86
 - cross-site scripting, 346–347
 - cryptanalysis, 448
 - cryptography. *See also* encryption; public key cryptography; steganography; symmetric encryption or symmetric key cryptography
 - algorithm versus implementation, 475–476
 - asymmetric encryption, 467–471
 - block ciphers, 463–465
 - cast of characters for examples, 460
 - CIA achievement, 456, 473–475
 - computationally secure, 461–462
 - defined, 24
 - hash functions, 458, 471–473
 - historic overview, 449–455
 - in Kerberos SSO system, 87–89, 532–533
 - in KryptoKnight SSO system (IBM), 90
 - mathematical attacks, 563
 - one-time pad, 453–454, 462, 540
 - overview, 443–444
 - packet filtering and, 432
 - primitives, 455–460
 - proprietary versus open source algorithms, 476–477
 - random number generation, 454–455, 456–460
 - in SESAME SSO system, 90
 - sharing keys, 465–467
 - steganography versus, 479, 493–495
 - stream ciphers, 462–463
 - substitution ciphers, 449–455
 - symmetric encryption, 460–467
 - terminology, 448–449
 - Vigenere cipher, 450–453
 - XOR function for, 454
 - CSIRTs (Computer Security and Incident Response Teams)
 - CERT/CC response team, 585, 586
 - FedCIRC response team, 585, 586
 - FIRST response team, 585, 586–587
 - issues addressed by, 585
 - levels of incidents, 587–588
 - reporting security incidents to, 587
 - response teams (table), 585
 - CSMA/CA (carrier sense multiple access with collision avoidance) protocol, 398
 - CTR (Counter) mode of AES, 409–410
 - cupsd print daemon (UNIX), 176
 - cupsd-lpd service (UNIX), 177
 - customer separation in Defense-in-Depth strategy, 99
 - cycle of a wave
 - cycles per second, 382
 - defined, 381
- ## D
- DAA (designated approving authority)
 - accreditation and, 14
 - defined, 32
 - DITSCAP, 599
 - evaluation and assessment process and, 42
 - NIACAP, 596, 598
 - risk management and, 32
 - D-AMPS (digital advanced mobile phone system), 389
 - data collection, UNIX security and, 161
 - Data Description Language (DDL), 90
 - data encapsulation
 - in Data Link layer (OSI), 374
 - defined, 368
 - in TCP/IP layers, 378
 - Data Encryption Standard (DES)
 - as block cipher, 465
 - as computationally secure, 461–462, 476
 - FTP server encryption and, 476
 - Kerberos and, 535
 - SSH and, 548
 - data handling, enforcing good, 130–132
 - data integrity. *See* integrity
 - Data Link layer (OSI)
 - Logical Link layer, 373–374
 - Media Access layer, 373
 - overview, 369, 373
 - protocols, 374

- data remanence, 74
- data sharing. *See also* NetBIOS (Windows)
 - FTP servers for, 358–360
 - LDAP servers for, 360–362
- data vulnerabilities for e-mail, 273–274
- database management system (DBMS), 90
- databases
 - for access control, 90–92
 - defined, 90
 - e-mail and automatic population of, 277
 - NIST vulnerability database, 36
 - object-oriented, 92
 - object-relational, 92
 - relational, 90–92
 - SQL injection, 267–268, 347–348
- datagrams, 423
- daytime service (UNIX), 177
- DBMS (database management system), 90
- DDL (Data Description Language), 90
- DDoS (distributed denial-of-service), 75, 559–560
- decryption
 - defined, 448
 - keys for, 461
- dedicated server for e-commerce, 270
- defense in multiple places, 9
- Defense-in-Depth strategy
 - areas comprised by, 6–7
 - attacks defended against, 8–9
 - critical elements, 6, 7
 - enclaves in, 7
 - implementation guidelines, 10
 - layers of protection, 99–100
 - operations, 8–10
 - overview, 620–621
 - people’s commitment to the process, 7
 - for server security, 336–337
 - steganography and, 485
 - techniques for defense, 9
 - technologies, 7–8
 - Windows security and, 99–100
- Define System Requirements process, 11, 19
- Define System Security Requirements process
 - Assess Information Protection Effectiveness
 - process tasks, 18
 - corresponding SE process, 11, 19
 - developing the system context, 14
 - functional requirements and constraints, 15
 - IPP solution set, 14
 - overview, 14–15
 - preliminary CONOPS, 14
- degree of a database, 91
- DELETE request (HTTP), 239
- deleting digital watermarks, 526
- demilitarized zone (DMZ), 419, 422
- demon dialing attacks, 567
- denial of service (DoS)
 - defined, 75, 151, 443, 559
 - distributed (DDoS), 75, 559–560
 - DNS misconfiguration and, 321
 - examples, 560
 - IDSs and, 440
 - overview, 559–560
 - packet filtering and, 431–432
 - preventing attacks (Windows), 151
 - spam attacks, 286–287
- Department of Defense. *See* DoD
- Departmental Restricted data, 131
- DES (Data Encryption Standard)
 - as block cipher, 465
 - as computationally secure, 461–462, 476
 - FTP server encryption and, 476
 - Kerberos and, 535
 - SSH and, 548
- design engineer tasks, 17
- Design System Architecture process, 11, 20
- Design System Security Architecture process
 - Assess Information Protection Effectiveness
 - process tasks, 18
 - corresponding SE process, 11, 20
 - functional architecture development, 15
 - functional decomposition process, 15
- designated approving (accrediting) authority (DAA)
 - accreditation and, 14
 - defined, 32
 - DITSCAP, 599
 - evaluation and assessment process and, 42
 - NIACAP, 596, 598
 - risk management and, 32
- designing DNS, 328–329
- designing secure servers
 - business impact assessment, 339–340
 - CCB responsibilities, 341–342
 - cost benefits of, 334
 - Defense-in-Depth strategy, 336–337
 - development environment for, 340–343
 - development practices, 344–351
 - factors affecting design efforts, 334
 - keeping things simple, 337
 - management support and, 341
 - mindset for, 335–340
 - network support for development, 343
 - overview, 334–335
 - respecting the adversary, 338
 - risk-based controls, 335–336
 - security awareness programs, 338–339
 - testing, 343, 351–353
- detection controls. *See also* ID (intrusion detection); IDSs (intrusion detection systems)
 - detective/administrative access control, 82–83
 - detective/physical access control, 83
 - detective/technical access control, 83
 - hardware change detection, 162–163
 - management controls, 41
 - necessity of, 622
 - operational security controls, 42
 - preventive controls versus, 37
 - steganography and, 492, 493

- technical controls, 41
 - UNIX physical security and, 162–163, 165
- Develop Detailed Design process, 11, 20
- Develop Detailed Security Design process
 - Assess Information Protection Effectiveness process tasks, 18
 - corresponding SE process, 11, 20
 - information systems security engineer tasks, 16
 - overview, 15–16
- development/acquisition phase of the SDLC
 - activities, 29–30
 - described, 21
 - risk management in, 33
 - table summarizing, 26–28
- device drivers, UNIX kernel and, 167
- DHCP (Dynamic Host Configuration Protocol)
 - overview, 428
 - packet filtering and, 431
 - stateful versus stateless address assignment, 428
 - Windows port for, 108
- dictionary attack, 565
- Diffie, Whitfield (key exchange scheme creator), 538
- Diffie-Hellman key agreement protocol, 466–467, 538, 539
- digests, 471. *See also* hash functions (hash codes)
- Digimarc Watermarking Solutions program, 525
- digital advanced mobile phone system (D-AMPS), 389
- digital certificate technology. *See* certificates
- digital dead drop, 484–485
- Digital Network Architecture Session Control Protocol (DNA SCP), 371
- Digital Picture Envelope (DPE) steganographic program, 514–516
- digital signing
 - for ActiveX controls, 227, 258–259
 - in asymmetric encryption, 470–471
 - for e-mail, 289, 531–532
 - man-in-the-middle attacks avoided by, 282, 284
 - network-based IDSs and, 569
 - performance and, 470–471
 - PGP scheme, 531–532
 - in PKI, 539
 - signature-based IDSs, 568, 570
 - trusted signature introducers, 541
- digital watermarking. *See also* steganography
 - defined, 481, 521
 - goals of, 522, 523–524
 - invisible, 522–523
 - as limited form of steganography, 521
 - need for, 520, 521
 - noise and, 522
 - overview, 520
 - products for creating, 525
 - properties of, 521–522
 - removing digital watermarks, 526
 - steganography versus, 524
 - uses for, 524–525
 - visible, 523
- digital-coded cards, 69
- direct sequence spread spectrum (DSSS), 395
- directories, enumerating, 266–267
- disabling
 - ActiveX controls, 227–228
 - Java applets, 228–229
 - JavaScript or Jscript, 229–230
 - scripting for e-mail, 301, 303
 - services, 355
- disaster recovery plan
 - defined, 59
 - development, 64
 - implementation, 67
 - testing, 66
- disaster recovery planning
 - defined, 59
 - establishing backup sites, 65–66
 - goals, 64
 - plan implementation, 67
 - plan testing, 66
 - process, 64–65
 - recovery time frame objectives, 64–65
 - terminology, 59
- Discover Information Protection Needs process
 - Assess Information Protection Effectiveness process tasks, 18
 - certification and accreditation (C&A), 14
 - concept of operations (CONOPS) document, 12
 - corresponding SE process, 11, 19
 - documentation of, 13
 - information management model (IMM), 12–13
 - mission needs statement (MNS), 12
 - objectives, 11
 - overview, 11–14
- Discover Needs process, 11, 19
- discrete logarithm problem, 466
- discretionary access control, 79–80
- disk partitioning, physical security and, 163–164
- disposal phase of the SDLC
 - activities, 31
 - described, 22
 - risk management in, 33
 - table summarizing, 26–28
- distributed denial-of-service (DDoS), 75, 559–560
- distributed IDSs, 438
- Distributed Mail Systems Protocol, 530
- distribution attacks, 9
- DITSCAP (DoD Information Technology Security Certification and Accreditation Process), 598–599
- DMZ (demilitarized zone), 419, 422
- DNA SCP (Digital Network Architecture Session Control Protocol), 371
- DNS (Domain Name System)
 - alternative approaches, 318–319
 - AOL DNS update from spoofed e-mail, 320–321
 - architecture, 331–332
 - attacks, 326–328
 - cache poisoning, 327–328, 330
 - defined, 369
 - designing, 329–330
 - development of, 309

- DNS (Domain Name System) (*continued*)
 - disabling, 355
 - domain name registration, 310
 - DoS attacks, 321
 - forward lookups, 315–316
 - fully qualified domain names, 310
 - information leakage, 321
 - iterative queries, 325–326
 - master slave DNS, 331
 - misconfigurations, 321
 - port scanning and, 564
 - predictable query IDs, 325
 - purpose of, 310–311
 - recursive queries, 325–326
 - reverse lookups, 316–318
 - security issues, 319–326
 - service redirection, 321
 - split DNS design, 328
 - split-split DNS design, 328–329
 - spoofing, 327–328
 - subdomains, 311
 - top-level domains, 310–315
 - vulnerability statistics, 327
 - Windows port for, 108
 - zone transfers, 322–324
 - DNSSEC (DNS security extensions), 324
 - documentation change control, 58–59
 - documenting
 - Discover Information Protection Needs process, 13
 - risk assessment results, 40
 - system hardening in Windows, 106
 - DoD (Department of Defense)
 - DoD 5000.2-R Change 3, 49
 - DoD 5000.2-R SE processes, 11
 - DoD Information Technology Security Certification and Accreditation Process (DITSCAP), 598–599
 - MIL-HDBK-881, 51–53
 - MIL-STD-499A, 54
 - program management techniques refined by, 48
 - program manager responsibilities and, 49
 - TPM described by, 54
 - WBS overview by, 51
 - dogs, 68
 - do-it-yourself e-commerce, 270–271
 - Domain Name System. *See* DNS
 - domain names. *See also* DNS (Domain Name System)
 - alternative approaches to resolution, 318–319
 - blacklists, 287
 - enumerating, 324
 - forward DNS lookups, 315–316
 - fully qualified, 310
 - optimization in name servers, 316, 317, 318
 - registration of, 310
 - reverse DNS lookups, 316–318
 - subdomains and, 311
 - top-level domain names, 310–315
 - domain of a database, 91
 - domainname file (UNIX), 173
 - DoS (denial of service)
 - defined, 75, 151, 443, 559
 - distributed (DDoS), 75, 559–560
 - DNS misconfiguration and, 321
 - examples, 560
 - IDSs and, 440
 - overview, 559–560
 - packet filtering and, 431–432
 - preventing attacks (Windows), 151
 - spam attacks, 286–287
 - downloading files
 - new SMTP versions, 302
 - virus spread and, 116, 557
 - downtime, maximum tolerable, 61
 - DPE (Digital Picture Envelope) steganographic program, 514–516
 - Dragon Sensor IDS, 435
 - drivers, UNIX kernel and, 167
 - droppers for viruses, 559
 - dry contact switches, 69
 - DSSS (direct sequence spread spectrum), 395
 - dumpster diving, 564
 - DVDs, proprietary encryption in, 477
 - Dynamic Host Configuration Protocol (DHCP)
 - overview, 428
 - packet filtering and, 431
 - stateful versus stateless address assignment, 428
 - Windows port for, 108
 - dynamic passwords, 85
 - dynamic scripting security risks, 348
- ## E
- EAM (Enterprise Access Management), 87
 - EAP (Extensible Authentication Protocol), 402–403
 - EAPOL (EAP over LAN), 402–403
 - ease of installation, Windows security and, 101–102
 - ease-of-use versus security, 101
 - Easter eggs, 487
 - eavesdropping
 - overview, 566
 - Web browsers and, 204
 - Web bugs and, 264–265
 - ECB (electronic code book), 464, 465
 - echo service (UNIX)
 - defined, 177
 - disabling, 355
 - e-commerce design
 - co-location, 270
 - dedicated server, 270
 - do-it-yourself, 270–271
 - important decisions, 269
 - physical location, 269–271
 - virtual hosting, 269–270
 - EDGE (Enhanced Data rate for GSM Evolution), 393
 - EHF (Extremely High Frequency), 383
 - ElGamal key exchange protocol, 467
 - 802.11 wireless security. *See* wireless security

- 802.11i wireless security standard
 - additional capabilities, 413
 - AES application in, 412–413
 - AES CBC mode, 409, 410–411
 - AES CTR mode, 409–410
 - AES MIC generation, 411–412
 - keys, 408–409
- 802.1X authentication, 402–403
- EIKONAmak digital watermarking program, 525
- EIR (equipment identity register), 384
- electrical power, physical security and, 72
- electromagnetic spectrum
 - cellular and wireless bands, 383
 - defined, 382
- electronic code book (ECB), 464, 465
- electronic monitoring, 76
- Electronic Serial Number (ESN), 384
- eliminate all means of intruder access (CERT/CC practice), 582
- e-mail
 - AOL DNS update from spoofed e-mail, 320–321
 - APOP authentication, 297–298
 - architectural considerations, 302–303
 - ARP spoofing, 281–284
 - ASCII text in, 275
 - authentication, 294–295, 296–300
 - availability issues, 290
 - being paranoid, 300–301
 - collaboration tools versus simple e-mail, 274
 - data integrity issues, 281–285
 - data vulnerabilities, 273–274
 - digital signing, 289, 531–532
 - disabling scripting, 301, 303
 - encryption, 289–290, 307
 - GSSAPI authentication, 300
 - Internet Explorer settings, 233
 - investigative searching for addresses, 267
 - keeping current with applications, 302
 - Kerberos authentication, 299–300, 532–533
 - login authentication, 297
 - mail client configurations, 301
 - maintaining confidentiality, 288–289
 - maintaining integrity, 289–290
 - malcode attacks, 275–277
 - man-in-the-middle attacks, 281–284
 - NTLM/SPA authentication, 298–299
 - operating safely, 300–307
 - overview, 308, 530
 - PC surveillance tools and, 149
 - PGP for, 307, 531–532
 - plain authentication, 296–297
 - POP before SMTP authentication, 299
 - popularity of, 530
 - Preview feature, avoiding, 301
 - privacy data loss and, 277–281
 - protocols, 290–296, 530
 - replay attacks, 284–285
 - security risks, 273–290
 - spam, 285–288
 - SSH for securing, 118–119, 303–307
 - by stable personalities, 122
 - user groups for, 125
 - virus spread and, 116, 132–133, 146, 557
 - Windows business workstation security, 114
 - Windows gaming systems, 115
- employee cooperation, 615–616
- Encapsulating Security Payload (ESP), 546–547
- encapsulation
 - in Data Link layer (OSI), 374
 - defined, 368
 - in TCP/IP layers, 378
- enclaves, 7
- encryption. *See also* cryptography
 - asymmetric (two-key), 467–471
 - for cookies, 350
 - defined, 449
 - determining if text is encrypted, 494–495
 - 802.11i wireless security standard, 408–413
 - e-mail, 289–290, 307
 - GNU Privacy Guard (GPG), 195, 307
 - IMAP and, 530
 - Internet Explorer, 236
 - man-in-the-middle attacks avoided by, 282
 - MIME encoding, 530
 - Netscape, 230
 - of passwords, 344–345
 - POP and, 128–129, 530
 - Pretty Good Privacy (PGP), 119, 307, 531–532
 - software development and, 349–351
 - SSH and, 548
 - SSL (Secure Sockets Layer), 212–216, 349
 - steganography with, 480, 493–495
 - symmetric, 460–467
 - UNIX security, 194–196
 - verifying data integrity using, 350
 - VPN (Virtual Private Network), 349
 - WEP upgrades, 402–408
 - WEP (Wired Equivalent Privacy), 400–402
- end of file (EOF) marker, steganography using, 498
- Engelbart, Doug (NLS inventor), 247
- “Engineering Principles for Information Technology Security” (EP-ITS) (NIST publication)
 - described, 22, 604
 - list of principles, 24–25
- engineering processes of SSE-CMM, 592
- Enhanced Data rate for GSM Evolution (EDGE), 393
- Enhanced Total Access Communication System (ETACS), 389, 391
- Enigma cryptography machine, 455
- enrollment time in biometrics, 71, 86
- Enterprise Access Management (EAM), 87
- enumerating
 - directories, 266–267
 - domain names, 324

- environment, steganography used in, 489
 - environment variables
 - CGI scripts and, 252
 - PHP pages and, 253
 - environmental issues
 - electrical power, 72
 - humidity, 72–73
 - EOF (end of file) marker, steganography using, 498
 - EP-ITS. *See* “Engineering Principles for Information Technology Security” (NIST publication)
 - equipment identity register (EIR), 384
 - erasing digital watermarks, 526
 - ESN (Electronic Serial Number), 384
 - ESP (Encapsulating Security Payload), 546–547
 - espionage, corporate, 617–618
 - establish response policies and procedures (CERT/CC practice), 579
 - ETACS (Enhanced Total Access Communication System), 389, 391
 - `/etc/hosts` file, name resolution using, 318–319
 - Ethereal traffic sniffer (UNIX), 157
 - ethical hacking. *See* penetration testing
 - E-Trust IDS, 435
 - evaluation. *See also* testing
 - in risk management, 32, 42
 - test and evaluation master plan (TEMP), 32
 - Excel (Microsoft) macro viruses, 558
 - executables, Web browsers and, 206
 - Extensible Authentication Protocol (EAP), 402–403
 - external consistency, 4
 - external penetration test, 609
 - Extremely High Frequency (EHF), 383
 - Eyes Only data, 132
 - EZ-Stego steganographic program, 511–512
- F**
- facility planning, 72
 - facility security management, 72
 - false acceptance rate (FAR), 71, 86
 - false negative IDS result, 441
 - false positive IDS result, 441
 - false rejection rate (FRR), 71, 86
 - FAR (false acceptance rate), 71, 86
 - fast frequency hopping spread spectrum (FFHSS), 396
 - FDD (Frequency Division Duplex) mode, 390
 - FDMA (Frequency Division Multiple Access)
 - for AMPS, 388
 - for IMT-2000, 389
 - for NMT, 389
 - overview, 386–387
 - FedCIRC (Federal Computer Incident Response Center), 585, 586
 - Federal Information Processing Standard (FIPS) 102, 600
 - Federal Information Technology Security Assessment Framework (FITSAF), 595–596
 - Federal Wiretap Act (1968), 576
 - fencing, 68
 - Ferguson, Niels (TKIP MIC developer), 406
 - FFHSS (fast frequency hopping spread spectrum), 396
 - FHSS (frequency hopping spread spectrum)
 - in Bluetooth, 413, 414
 - overview, 395–396
 - fields (HTML), tracking state with hidden, 266
 - file extensions, disabling hiding in Windows, 151
 - file infector viruses, 558
 - file ownership (UNIX), 158
 - file permissions
 - UNIX security and, 188–190
 - Windows security and, 111
 - file sharing
 - UNIX services, 166
 - virus spread and, 116
 - Windows business workstation security, 114
 - File Transfer Protocol. *See* FTP
 - file transfers
 - UNIX services, 166
 - Windows business workstation security, 114
 - filters for spam, 287–288
 - finger service (UNIX)
 - defined, 177
 - disabling, 355
 - “finish” message (SSL), 552
 - FIPS (Federal Information Processing Standard) 102, 600
 - fire extinguishing systems, 74
 - fire suppression, 73–74
 - firewalls
 - for developers, 343
 - disadvantages of, 434–435
 - example, 429–430
 - iptables (UNIX), 168
 - NAT and, 421
 - need for, 429
 - packet filtering, 430–433
 - as perimeter defense, 419
 - proxy firewalls, 433–434
 - reasons for employing, 429
 - SSL and, 553–554
 - stateful packet-filtering techniques, 432–433
 - firewalls (Windows)
 - for business workstations, 114
 - Microsoft recommendations, 103, 104
 - for networks, 121–122
 - personal, 118
 - FIRST (Forum of Incident Response and Security Teams), 585, 586–587
 - FITSAF (Federal Information Technology Security Assessment Framework), 595–596
 - flat or linear key space, 562
 - flow charts (TPM), 54
 - foreign key, 91
 - formal processes
 - Defense-in-Depth strategy, 6–10
 - Information Assurance Technical Framework, 6–11
 - structured approach provided by, 5
 - systems engineering processes, 5–6, 10–11

Forum of Incident Response and Security Teams (FIRST), 585, 586–587

forward DNS lookups, 315–316

Fourth Amendment rights, 576

fragmentation attacks, 562

frames

- hidden, for tracking state, 265–266
- lost, switches and, 423
- source-routed (UNIX), 168

FreeBsd. *See* UNIX security

frequency

- defined, 382
- relationship between wavelength and, 382
- UHF band, 383

frequency analysis for breaking encryption, 451–453

Frequency Division Duplex (FDD) mode, 390

Frequency Division Multiple Access (FDMA)

- for AMPS, 388
- for IMT-2000, 389
- for NMT, 389
- overview, 386–387

frequency hopping spread spectrum (FHSS)

- in Bluetooth, 413, 414
- overview, 395–396

FRR (false rejection rate), 71, 86

FTP (File Transfer Protocol)

- anonymous FTP, 358–359, 360
- avoiding services (UNIX), 175
- data encryption not provided by, 128–129
- defined, 369
- disabling, 355
- minimizing risks, 359–360
- servers, 358–360
- TFTP (Trivial File Transfer Protocol), 369
- transition to HTTP on the Internet, 237
- using sFTP instead, 104, 119, 130

full knowledge penetration test, 609

fully qualified domain names, 310

functional decomposition, 15

G

games

- risky, 123
- user groups for, 125
- Windows security for gaming systems, 114–115

gateways

- as network segment boundaries, 418
- overview, 424
- specifications and features, 424

General Packet Radio Service (GPRS) protocol, 393

“Generally Accepted Principles and Practices for Securing Information Technology Systems” (NIST publication)

- common security practices, 23–24, 603–604
- described, 22
- information security principles, 22–23, 603
- SDLC phases defined in, 21

generation steganography, 501

Generic Practices (GPs) of SE-CMM, 592, 593

Generic Security Services Application Programming Interface (GSSAPI), 300

GET request (HTTP)

- overview, 211, 238, 250
- SSL sessions and, 214

ghost images, system hardening in Windows and, 106, 137

GID (group ID) flag (UNIX), 189, 190–191

Gif Shuffle steganographic program, 517–518

GIFs, Web bugs in, 264–265

Giovanni digital watermarking program (BlueSpike), 525

Global System for Mobile Communications (GSM), 388, 392

GNU zip (gzip) algorithm, 246

government policy types, 45

GPG (GNU Privacy Guard), 195, 307

gpm service (UNIX), 178

GPRS (General Packet Radio Service) protocol, 393

GPs (Generic Practices) of SE-CMM, 592, 593

grammar-based steganography, 497

graphics. *See* images; steganography

group ID (GID) flag (UNIX), 189, 190–191

GSM (Global System for Mobile Communications), 388, 392

GSSAPI (Generic Security Services Application Programming Interface), 300

guards, 68

guidelines, defined, 46

gzip (GNU zip) algorithm, 246

H

hackers, Defense-in-Depth strategy, 100

Handbook of Applied Cryptography (Menezes, Oorschot, and Vanstone), 458

Handheld Device Markup Language (HDML), 415

handshake

- HTTP, 242–244
- SSL, 550–553

hardening UNIX systems

- checking strong passwords, 198–199
- configuration items, 196–198
- general principles, 196
- packet filtering, 199–200
- TCP wrapper, 198

hardening Windows systems

- AUTORUN and, 111
- Defense-in-Depth strategy and, 99
- documenting, 106
- file permissions and, 111
- general process, 105–107
- ghost images and, 106, 137
- Microsoft recommendations, 103–104
- NTFS file system and, 111
- passwords for, 113

Continued

- hardening Windows systems (*continued*)
 - prior tasks, 105
 - Registry and, 111
 - securing business workstations, 114
 - securing gaming systems, 114–115
 - specific recommendations, 110–113
 - testing hardened systems, 107, 120
 - user groups rights for, 111–112
 - user level accounts for, 112–113
 - Windows 2003 new installation example, 107–109
- hardware detection (UNIX), 162–163
- hash functions (hash codes)
 - advantages of, 471
 - birthday attacks and, 564–565
 - cast of characters for examples, 460
 - caveats, 471–472
 - defined, 531
 - digests, 471
 - for digital signatures, 539
 - keyed functions, 473
 - performance and, 471
 - in PGP digital signing, 531–532
 - for pseudorandom number generation, 458, 472
 - strong hash codes, 531
- HDML (Handheld Device Markup Language), 415
- HEAD request (HTTP), 238
- Hellman, Martin (key exchange scheme creator), 538
- Herz, 382
- HF (High Frequency), 383
- hidden fields for tracking state, 266
- hidden frames for tracking state, 265–266
- Hide and Seek steganographic program, 506–507
- HIDS (host-based intrusion detection system)
 - characteristics, 570
 - defined, 568
 - learning curve for, 104
 - overview, 436, 569–570
 - on Windows workstations, 104
- High Frequency (HF), 383
- high-interaction honeypots, 574–575
- hijacking. *See also* man-in-the-middle attacks
 - cookies and, 217
 - defined, 204, 217
 - overview, 561
 - Web browsers and, 216–217
 - Windows security and, 152
- historic cryptography
 - Enigma cryptography machine, 455
 - one-time pad, 453–454, 462, 540
 - Purple cryptography machine, 455
 - random number generators, 454–455
 - substitution ciphers, 449–455
 - Vigenere cipher, 450–453
 - XOR function, 454
- history
 - of cryptography, 449–455
 - of steganography, 488–489
 - of zone transfer problems, 322
- history list configuration (Netscape), 231
- HLC (home location register), 384
- home location register (HLC), 384
- Honeyd application, 576–577
- Honeypot Project, 573, 577
- honeypots
 - defined, 573
 - detecting attacks, 573–574
 - high-interaction, 574–575
 - Honeyd application, 576–577
 - legal issues, 575–576
 - low-interaction, 574
 - preventing attacks, 573
 - production mode, 573, 575
 - purposes of, 573–574
 - research mode, 573, 575
 - responding to attacks, 574
 - when not to use, 575–576
 - when to use, 575
- host-based intrusion detection system (HIDS)
 - characteristics, 570
 - defined, 568
 - learning curve for, 104
 - overview, 436, 569–570
 - on Windows workstations, 104
- hostname file (UNIX), 173
- Host-to-Host layer. *See* Transport layer (TCP/IP)
- hot backup site, 65
- HTML (Hypertext Markup Language) code
 - authentication over sessions, 210–211
 - comments and security risks, 345
 - GET lines, 211, 214
 - hidden fields for tracking state, 266
 - hidden frames for tracking state, 265–266
 - overview, 206, 251
 - POST data, 211, 214
- HTTP (Hypertext Transfer Protocol)
 - burstable TCP service, 250–251
 - client/server model, 248–249
 - commands or methods, 238–239
 - compression in version 1.1, 246
 - defined, 205, 237, 370
 - handshake, 242–244
 - HTML and, 251
 - implementation, 242–244
 - information returned using, 205–206
 - maintaining state and, 211
 - persistent connections, 244, 246–248
 - protocols communicated with, 237
 - PUT request, 249
 - request and response model, 239–242
 - simple session example, 207–208
 - slow start algorithm, 244, 245

- standard request header, 240–241
 - as stateless protocol, 206
 - transition from FTP to, 237
 - URL tracking by, 265
 - version 1.0 versus 1.1, 242–248
 - httpd service (UNIX), 179
 - HTTP_REFERER environment variable, 252
 - HTTP_USER_AGENT environment variable, 252
 - hubs
 - IDSs and, 572
 - as network segment boundaries, 418
 - overview, 423
 - humidity, physical security and, 72–73
 - hypertext, 247
 - Hypertext Markup Language code. *See* HTML code
 - Hypertext Transfer Protocol. *See* HTTP
- I**
- IAM (Infosec Assessment Methodology), 594–595
 - IANA (Internet Assigned Numbers Authority), 379
 - IATF (Information Assurance Technical Framework)
 - Defense-in-Depth strategy, 6–10
 - implementation guidelines, 10
 - release 3.1 document online, 6
 - systems engineering processes, 10–11
 - IATFF (Information Assurance Technical Framework Forum), 6
 - IBM KryptoKnight SSO system, 90
 - ICMP (Internet Control Message Protocol)
 - defined, 372
 - packet filtering and, 431
 - ping-of-death attack, 560
 - smurf attack, 560
 - ID (intrusion detection). *See also* detection controls;
 - IDSs (intrusion detection systems)
 - antivirus approaches, 567–568
 - computer incident response team (CIRT) and, 568
 - defined, 568
 - honeypots, 573–577
 - incident handling, 577–588
 - necessity of, 622
 - overview, 589
 - primary components, 568
 - identification
 - biometrics for, 71, 85–86
 - defined, 4, 84
 - identify and implement security lessons learned
 - (CERT/CC practice), 583
 - identity-based access control, 80
 - IDSs (intrusion detection systems). *See also* response
 - to attacks (incident handling)
 - for access control, 83
 - anomaly-based, 439–440, 568, 571
 - centralized, 437, 438
 - common IDSs, 435–436
 - computer incident response team (CIRT) and, 568
 - cooperative agents, 438
 - in Defense-in-Depth, 9
 - detection results, 441
 - distributed, 438
 - host-based (HIDS), 104, 436–437, 568, 569–570
 - incident handling, 577–588
 - intrusion prevention systems, 439
 - issues, 571–572
 - layered security and, 584–585
 - misuse-based, 439, 440–441
 - network-based (NIDS), 437–438, 568, 569
 - overview, 435
 - pattern matching in, 440–441, 568, 570
 - responses to intrusion detection, 442
 - signature-based, 568, 570
 - types of attacks, 435
 - Windows security, 122
 - IEEE standards
 - 802 networking standards, 374–375
 - STD 1220-1998 SE processes, 10
 - wireless LAN standards, 397–399
 - IETF (Internet Engineering Task Force) *Site Security Handbook*, 583–584
 - ILOVEYOU virus, 146
 - IM (instant messaging), 149, 363–364
 - Image Hide steganographic program, 512–514
 - images. *See also* steganography
 - Web browsers and, 206
 - Web bugs in, 264–265
 - IMAP (Internet Message Access Protocol)
 - encryption and authentication, 530
 - overview, 295–296, 530
 - POP versus, 295, 530
 - imap service (UNIX), 177
 - imaps service (UNIX), 177
 - IMM (information management model), 12, 13
 - IMP (information management policy), 13
 - impact
 - analysis in risk assessment, 38–39
 - defined, 33
 - definitions of levels, 38
 - mission risk calculation and, 39
 - Implement System process, 11, 20
 - Implement System Security process
 - Assess Information Protection Effectiveness
 - process tasks, 19
 - components of the security solution, 16–17
 - corresponding SE process, 11, 20
 - described, 16
 - information systems security engineer tasks, 16
 - overview, 16–17
 - systems and design engineers tasks, 17
 - implementation phase of the SDLC
 - activities, 30
 - described, 21–22
 - risk management in, 33
 - table summarizing, 26–28
 - Important updates (Windows), 138
 - IMSI (International Mobile Subscriber Identity), 383

- IMT-2000 (International Mobile Telephone Standard 2000), 389, 392
- inappropriate system use, 566
- incident handling. *See* response to attacks (incident handling)
- index of coincidence, 451–452, 453
- inetd service (UNIX)
 - overview, 176, 184–185
 - services run via, 176–177
- Information Assurance Technical Framework (IATF)
 - Defense-in-Depth strategy, 6–10
 - implementation guidelines, 10
 - release 3.1 document online, 6
 - systems engineering processes, 10–11
- Information Assurance Technical Framework Forum (IATFF), 6
- information domains, IMM and, 12, 13
- information management model (IMM), 12, 13
- information management policy (IMP), 13
- Information Protection Policy (IPP), 13, 14
- Information System Security Engineering. *See* ISSE
- information system security management
 - business continuity planning, 59, 60–64
 - configuration management, 56–59
 - disaster recovery planning, 59, 64–67
 - legal and liability issues, 75–76
 - overview, 43, 77
 - physical security, 67–74
 - security awareness training, 46–48
 - security policies, 43–46
 - technical effort management, 48–55
- information system security officer (ISSO), 34
- information systems security engineer, process tasks, 16
- informative policies, 45
- Infosec Assessment Methodology (IAM), 594–595
- infrastructure wireless mode, 398
- init process (UNIX), 183–184
- initiation phase of the SDLC
 - activities, 29
 - described, 21
 - risk management in, 33
 - table summarizing, 26–28
- injection of SQL, 267–268, 347–348
- innd service (UNIX), 179
- input to programs
 - checking, 159, 346, 348–349
 - content injection and, 346
 - for pseudorandom number generation, 458
 - security issues, 159, 346–349
- insertion technique for steganography, 498–500
- insertion-based steganography, 496
- insider attacks, 9
- installation base, Windows security and, 101, 102
- installing applications (Windows)
 - antivirus software, 116–118
 - hardening the system first, 115
 - minimizing the number of, 115
 - personal firewalls, 118
 - Pretty Good Privacy (PGP), 119
 - secure FTP (sFTP), 119
 - Secure Shell (SSH), 118–119
- installing packages (UNIX)
 - listing all installed rpm packages, 167
 - packages that should not be installed unnecessarily, 166
- instant messaging (IM), 149, 363–364
- integrity. *See also* CIA properties
 - cryptography and, 456, 473–474
 - defined, 4, 456, 538
 - e-mail data integrity issues, 281–285
 - encryption for verifying, 350
 - goals of, 4
 - IPSec-based VPNs and, 544
 - as key principle, 3
 - maintaining for e-mail, 289–290
 - in network security, 4
 - as PKI service, 538
 - steganography and, 491
- internal consistency, 4
- internal penetration test, 608–609
- International Mobile Subscriber Identity (IMSI), 383
- International Mobile Telephone Standard 2000 (IMT-2000), 389, 392
- International Standard Organization (ISO) HTML standard, 251
- International Systems Security Engineering Association (ISSEA), 592
- Internet Assigned Numbers Authority (IANA), 379
- Internet connection. *See also* e-mail; Web browsers
 - Internet Explorer settings, 233
 - Windows business workstation security, 114
 - Windows gaming systems and, 115
- Internet Control Message Protocol (ICMP)
 - defined, 372
 - packet filtering and, 431
 - ping-of-death attack, 560
 - smurf attack, 560
- Internet Engineering Task Force (IETF) *Site Security Handbook*, 583–584
- Internet Explorer. *See also* Web browsers
 - accessing configuration options, 231
 - advanced settings, 235–236
 - Content settings, 235
 - cookie storage locations, 264
 - disabling ActiveX controls, 227–228
 - disabling Java applets, 229
 - disabling JavaScript or Jscript, 230
 - encryption, 236
 - general settings, 232
 - Internet settings, 232
 - local intranet settings, 233
 - Privacy settings, 234
 - restricted sites, 234
 - Security settings, 232–234
 - trusted sites, 233

- Internet layer (TCP/IP)
 - ARP and, 426
 - overview, 377
 - Internet Message Access Protocol (IMAP)
 - encryption and authentication, 530
 - overview, 295–296, 530
 - POP versus, 295, 530
 - Internet perimeter in Defense-in-Depth strategy, 99
 - Internet Protocol (IP), 372. *See also* IP addresses
 - Internet relay chat (IRC) security issues, 363–364
 - Internet resources
 - authoring clients, 249
 - CERT Coordination Center, 302
 - CISP, 222
 - “Compromising Emanations” (Kuhn, Markus G.), 72
 - digital watermarking products, 525
 - Ferguson, Niels, 406
 - Honeyd application, 576
 - IATF release 3.1 document, 6
 - ISSEA, 592
 - JibJab site, 250
 - Microsoft security site, 103
 - NIST vulnerability database, 36
 - OECD site, 22
 - password-cracking programs (UNIX), 198–199
 - TPM description, 54
 - intranets, Internet Explorer settings, 233
 - “An Introduction to Computer Security” (NIST publication), 45
 - intrusion detection. *See* ID
 - intrusion detection systems. *See* IDSs
 - intrusion prevention systems, 439
 - inventory, UNIX security and, 165
 - investigative searching for e-mail addresses, 267
 - invisibility as goal of steganography, 492
 - invisible watermarking, 522–523
 - IP addresses
 - blacklists, 287
 - blocking by IDSs, 442
 - class-ID in, 425
 - DNS and translation of, 310
 - forward DNS lookups, 315–316
 - host-ID in, 425
 - NAT for increasing, 420, 421
 - net-ID in, 425
 - network classes, 376–377
 - overview, 424–425
 - packet filtering metrics, 430–431
 - reverse DNS lookups, 316–318
 - stateful versus stateless assignment, 428
 - subnetting and, 424
 - IP forwarding option (UNIX kernel), 168
 - IP (Internet Protocol), 372
 - IP packet filtering. *See* packet filtering
 - IP packets, privacy data loss and, 277–281
 - IP spoofing. *See* spoofing
 - ipop2 service (UNIX), 177
 - ipop3 service (UNIX), 177
 - IPP (Information Protection Policy), 13, 14
 - IPSec-based VPNs
 - Authentication Header (AH), 545–546
 - Encapsulating Security Payload (ESP), 546–547
 - overview, 544
 - security associations (SAs), 545
 - transport mode, 545
 - tunneled mode, 545
 - iptables firewall (UNIX)
 - described, 176
 - kernel option, 168
 - packet filtering, 199–200
 - IRC (Internet relay chat) security issues, 363–364
 - irda service (UNIX), 179
 - IRIX operating system, 565
 - ISAAC stream cipher, 462
 - ISO (International Standard Organization) HTML standard, 251
 - ISSE (Information System Security Engineering)
 - Assess Information Protection Effectiveness process, 11, 17–19, 21
 - corresponding SE and ISSE activities, 19–21
 - Define System Security Requirements process, 11, 14–15, 18, 19
 - Design System Security Architecture process, 11, 15, 18, 20
 - Develop Detailed Security Design process, 11, 15–16, 18, 20
 - Discover Information Protection Needs process, 11–14, 18, 19
 - Implement System Security process, 11, 16–17, 19, 20
 - processes, 11–21
 - ISSEA (International Systems Security Engineering Association), 592
 - ISSO (information system security officer), 34
 - issue-specific policies, 23, 45
 - iterative queries (DNS), 325–326
- ## J
- Java applets
 - defined, 226, 228
 - disabling, 228–229
 - JavaScript versus, 227
 - security features, 228
 - Java language
 - buffer overflows and, 346
 - development of, 255
 - permissions, 256–257
 - sandbox and security, 255–256
 - JavaScript or Jscript
 - ActiveX controls versus, 226
 - defined, 226
 - disabling, 229–230
 - HTML tag identifying, 254
 - Java applets versus, 227
 - security issues, 229, 254–255

John The Ripper password cracker (UNIX), 198
 join database operation, 91
 Joint Photographic Experts Group (JPEG), 370
 journaling, 163
 JPEG Test, 526
 Jsteg steganographic program
 extracting data using, 511
 hiding data using, 508–510
 overview, 508

K

Kawaguchi, Eiji (BCPS creator), 514
 KCK (key confirmation key), 409
 kcore file (UNIX), 173
 KDC (Key Distribution Center)
 in Kerberos SSO, 87
 in KryptoKnight SSO, 90
 KEK (key encryption key), 408
 Kerberos
 certificates, 532–533
 client-server authentication, 535–537
 defined, 532
 development of, 532
 e-mail authentication, 299–300, 532–533
 PKI and, 539
 SSO system, 87–89
 ticket granting, 87–89, 536–537
 working model, 535–537
 kernel (UNIX)
 defined, 167
 device drivers, 167
 listing all loaded modules, 169–170
 modules, 169–170
 options, 168–169
 /proc file system, 172–173
 supervisor mode versus user mode, 167
 system calls, 170–172
 kernel/ctrl-alt-del file (UNIX), 173
 key agreement protocols, 466–467
 key confirmation key (KCK), 409
 Key Distribution Center (KDC)
 in Kerberos SSO, 87
 in KryptoKnight SSO, 90
 key encryption key (KEK), 408
 key management infrastructures/public key
 infrastructures (KMI/PKI), 9. *See also* PKI
 (Public Key Infrastructure)
 keys (cryptographic). *See also* cryptography;
 encryption
 AES, 408–409
 defined, 449
 for encrypting versus decrypting, 461
 for hash functions, 473
 key agreement protocols, 466–467
 keyword for Vigenere cipher, 450
 linear or flat key space, 562
 nonlinear key space, 562

 pre-shared secret, 465
 reuse of, 452, 453
 session keys, 532, 535
 in SSL, 551
 for substitution ciphers, 450
 weak, 562
 keytable service (UNIX), 176
 kiloHerz, 382
 KMI/PKI (key management infrastructures/public key
 infrastructures), 9. *See also* PKI (Public Key
 Infrastructure)
 knowing software running on your system, 129–130,
 621–622
 knowledge-based IDss, 568, 570
 KryptoKnight SSO system (IBM), 90
 ksh scripting language (UNIX), 157
 ktalk service (UNIX), 177
 kudzu hardware detection (UNIX), 162–163, 176
 Kuhn, Markus G. (“Compromising Emanations”), 72

L

LAN (local area network)
 for hardened Windows workstation, 120–121
 LAN-to-LAN VPNs, 543–544
 Layer 1. *See* Network Access layer (TCP/IP); Physical
 layer (OSI)
 Layer 2. *See* Data Link layer (OSI); Internet layer
 (TCP/IP)
 Layer 3. *See* Network layer (OSI); Transport layer
 (TCP/IP)
 Layer 4. *See* Application layer (TCP/IP); Transport
 layer (OSI)
 Layer 5. *See* Session layer (OSI)
 Layer 6. *See* Presentation layer (OSI)
 Layer 7. *See* Application layer (OSI)
 layered architecture
 OSI layers, 369–375
 OSI model, 368–369
 overview, 367–368, 379
 TCP/IP layers, 377–378
 TCP/IP model, 375–377
 WAP and, 415–416
 wireless networking, 397–398
 layered defenses, 9
 layered security and IDS, 584–585
 LCG algorithm, 457, 458
 LDAP (Lightweight Directory Access Protocol),
 360–362
 least privilege principle, 12, 621
 least significant bits (LSB), steganography using, 496,
 503–504
 legal issues
 electronic monitoring, 76
 Honeypot Project, 573, 577
 honeypots and, 575–576
 liability, 76
 types of computer crime, 75

- levels
 - of capability (FITSAF), 596
 - of GP maturity (SE-CMM), 593
 - of impact, 39
 - of incidents (CSIRT), 587–588
 - of INFOSEC assessment, 594
 - of likelihood, 37
 - of WBS activity, 51
 - LF (Low Frequency), 383
 - LFHSS (low frequency hopping spread spectrum), 396
 - liability issues, 76
 - life-cycle planning, 23
 - lighting, 68
 - Lightweight Directory Access Protocol (LDAP), 360–362
 - likelihood
 - definitions of levels, 37
 - determination in risk assessment, 37–38
 - mission risk calculation and, 39
 - linear or flat key space, 562
 - Link Control Protocol, 374
 - Linux. *See* UNIX security
 - lipogram, 451
 - local area network (LAN)
 - for hardened Windows workstation, 120–121
 - LAN-to-LAN VPNs, 543–544
 - Local Security Authority (LSA), 109
 - locks, 68
 - logging
 - analyzing log data, 616
 - operating servers safely, 357–358
 - reverse DNS lookups and, 317
 - Windows security and, 144
 - logic bombs, 559. *See also* malicious code (malcode or malware)
 - logic flaws, open source implementations and, 158–160
 - logical access control, 24
 - Logical Link layer (OSI), 373–374
 - login authentication for e-mail, 297
 - loss impact analysis, 62
 - low frequency hopping spread spectrum (LFHSS), 396
 - Low Frequency (LF), 383
 - Low updates (Windows), 139
 - low-interaction honeypots, 574
 - lpd print daemon (UNIX), 176
 - LSA (Local Security Authority), 109
 - LSB (least significant bits), steganography using, 496, 503–504
 - lsmod command (UNIX), 169–170
- M**
- MAC (Media Access Control) addresses, 423, 426–427
 - MAC (medium access control) layer, 397, 398
 - macro viruses, 558
 - mail command, 304
 - mail servers
 - CERT/CC, 302
 - not installing unnecessarily (UNIX), 166
 - malicious code (malcode or malware). *See also specific kinds*
 - in ASCII form, 275–277
 - avoiding, 132–133
 - defined, 75
 - e-mail attacks, 275–277
 - hidden file extensions and (Windows), 151
 - overview, 557–559
 - protecting against (UNIX), 174
 - Web browsers and, 204, 216
 - Windows gaming systems and, 114–115
 - management controls, 41
 - management, selling security to, 613–614
 - managing users in Defense-in-Depth strategy, 99
 - mandatory access control, 80
 - man-in-the-middle attacks. *See also* hijacking; replay attacks
 - ARP spoofing, 282–284
 - avoiding, 282, 284
 - e-mail risks, 281–284
 - key agreement protocols and, 466–467
 - overview, 561
 - Web browser risks, 204, 216
 - mantraps, 68
 - Massachusetts Institute of Technology, 532
 - master slave DNS, 331
 - mathematical attacks, 563
 - maximum tolerable downtime, 61
 - Maximum Transmission Unit (MTU), 374
 - McAfee antivirus software (Network Associates), 103, 117
 - MD (message digest), birthday attacks and, 564–565
 - MD5 (Message Digest Algorithm), 539
 - measuring security awareness, 47
 - Media Access Control (MAC) addresses, 423, 426–427
 - Media Access layer (OSI), 373
 - MediaSec Technologies' SysCop digital watermarking program, 525
 - medium access control (MAC) layer, 397, 398
 - Medium Frequency (MF), 383
 - Melissa virus, 146
 - Menezes (*Handbook of Applied Cryptography*), 458
 - Message Digest Algorithm (MD5), 539
 - message digest (MD), birthday attacks and, 564–565
 - metadata in Microsoft Word documents, 131
 - MF (Medium Frequency), 383
 - MIC (Message Integrity Code)
 - AES generation, 411–412
 - TKIP upgrade, 405–407
 - microdots, 481
 - Microsoft. *See also* Windows security; Word
 - Excel, 558
 - MSN, 363
 - Outlook, 274, 301
 - ratings for security updates, 138–139
 - security recommendations, 103–104
 - upgrades and patches, 138–139

- MIME (Multipurpose Internet Mail Extensions), 370, 530
 - misconfigurations
 - anonymous FTP, 359
 - DNS, 321
 - mission needs statement (MNS), 12
 - mission risk calculation, 39
 - misuse-based IDSs, 439, 440–441
 - mobile station, 383
 - mobile switching center (MSC), 384
 - Mockapetris, Paul (DNS developer), 309
 - modems (modulators-demodulators)
 - overview, 422
 - war dialing and demon dialing attacks, 567
 - Moderate updates (Windows), 138
 - modification of information
 - modification attacks, 559
 - prevention as goal of integrity, 4
 - monitoring. *See also* checking; ID (intrusion detection)
 - defined, 611
 - electronic, legal issues for, 76
 - operating servers safely, 357–358
 - overview, 611–612
 - penetration testing, 607–610, 612
 - violation analysis, 612
 - Windows security, 143
 - Motion Picture Experts Group (MPEG), 370
 - MSC (mobile switching center), 384
 - MSN (Microsoft Subscription Network), 363
 - MTU (Maximum Transmission Unit), 374
 - multimedia, 123
 - Multimode Terminal mode, 390
 - multipartite viruses, 558
 - multiple-center processing, 66
 - multiprocessor support option (UNIX kernel), 168
 - Multipurpose Internet Mail Extensions (MIME), 370, 530
 - mutual aid agreements, 65
 - mysqld service (UNIX), 179
- N**
- name servers. *See also* DNS (Domain Name System)
 - address information optimization in, 316, 317, 318
 - iterative queries, 325–326
 - neglect of, 319
 - predictable query IDs, 325
 - recursive queries, 325–326
 - security issues, 319–326
 - zone transfers, 322–324
 - named service (UNIX), 179
 - name-to-address resolution (forward lookups), 315–316
 - Narrow-Band Total Access Communication System (NTACS), 391
 - NAT (Network Address Translation)
 - defined, 420
 - firewalls and, 421
 - overview, 379, 420–421
 - translation tables, 421
 - National Fire Protection Association (NFPA), 73
 - National Information Assurance Certification and Accreditation Process (NIACAP)
 - phases of, 597
 - roles and functions, 598
 - System Security Authorization Agreement (SSAA), 596–597
 - types of accreditation, 597
 - National Institute of Standards and Technology. *See* NIST
 - National Security Agency (NSA), 6
 - Needham Schroeder authentication protocol, 533
 - Nelson, Ted (hypertext coiner), 247
 - Nessus vulnerability scanner (UNIX), 157
 - net account command (Windows), 113
 - net localgroup command (Windows), 113
 - net share command (Windows), 135
 - net start command (Windows), 107
 - net subdirectory (UNIX), 173
 - net use command (Windows), 135
 - net/arp subdirectory (UNIX), 173
 - NetBIOS (Windows)
 - antivirus protection and, 116
 - determining available shares, 135
 - limiting use of, 135
 - ports for, 108–109
 - removing, 135
 - sFTP versus NetBIOS file shares, 119
 - netfs service (UNIX), 179
 - Netscape. *See also* Web browsers
 - clearing the cache, 231
 - cookie storage locations, 264
 - cookies configuration, 230–231
 - disabling Java applets, 228
 - disabling JavaScript or Jscript, 229–230
 - encryption, 230
 - history list configuration, 231
 - SSL integration, 549
 - netstat -a command (Windows), 104
 - netstat command (UNIX), 180–181, 355
 - Network Access layer (TCP/IP), 378
 - Network Address Translation (NAT)
 - defined, 420
 - firewalls and, 421
 - overview, 379, 420–421
 - translation tables, 421
 - network architecture
 - Address Resolution Protocol (ARP), 426–427
 - building blocks, 422–424
 - common attacks, 442–443
 - complexity of, 417
 - components and applications, 417
 - Dynamic Host Configuration Protocol (DHCP), 428
 - firewalls, 429–435
 - intrusion detection systems, 435–441
 - Media Access Control (MAC) addresses, 426–427
 - Network Address Translation (NAT), 420–421
 - network segments, 418–419

- perimeter defense, 419–420
- responses to intrusion detection, 442
 - subnetting, switching, and VLANs, 424–426
- Network Associates' McAfee antivirus software, 103, 117
- Network Control Protocol, 374
- Network File System (NFS), 175, 371
- network intrusions, 75
- Network layer (OSI)
 - functions, 372
 - overview, 369, 372
 - protocols, 372–373
 - routers and, 423
- network scanners, 443
- network segments, 418–419
- network service (UNIX), 176
- Network Solutions, 310
- network tools, UNIX vulnerability and, 156–157
- network-based intrusion detection system (NIDS), 437–438, 568, 569
- New Technology File System (NTFS), 111
- NFPA (National Fire Protection Association), 73
- NFS (Network File System), 175, 371
- nfslock service (UNIX), 175
- NIACAP (National Information Assurance Certification and Accreditation Process)
 - phases of, 597
 - roles and functions, 598
 - System Security Authorization Agreement (SSAA), 596–597
 - types of accreditation, 597
- NIDS (network-based intrusion detection system), 437–438, 568, 569
- NIST (National Institute of Standards and Technology)
 - assessment guidelines, 602–607
 - DES cryptography, 465, 476
 - “Engineering Principles for Information Technology Security” (EP-ITS), 22, 24–25, 604
 - “Generally Accepted Principles and Practices for Securing Information Technology Systems,” 21, 22–24, 603–604
 - “An Introduction to Computer Security,” 45
 - “Risk Management Guide for Information Technology Systems,” 31–42, 604–606
 - “Security Considerations in the Information System Development Life Cycle,” 22, 25–31, 606–607
 - Security Self-Assessment Guide for Information Technology Systems*, 36
 - vulnerability database, 36
- nmap port scanner (UNIX), 157, 182
- NMT (Nordic Mobile Telephone), 389, 391
- noise
 - defined, 506
 - digital watermarking and, 522, 526
 - file structure tolerance for, 522
 - Hide and Seek program and, 506
 - PSNR (peak signal-to-noise ratio), 526
- non-discretionary access control, 81
- nonlinear key space, 562

- nonpersistent versus persistent cookies, 209, 242
- non-repudiation
 - defined, 538
 - as PKI service, 538, 540
- Nordic Mobile Telephone (NMT), 389, 391
- normalizing data, 92
- Novell Web server, 565
- NSA (National Security Agency), 6
- nscd service (UNIX), 179
- NTACS (Narrow-Band Total Access Communication System), 391
- ntalk service (UNIX), 177
- NTFS (New Technology File System), 111
- NTLM (NT LanManager), 298–299
- ntpd service (UNIX), 179
- null sessions, Windows security and, 109, 136–137

O

- object, defined, 79
- object reuse, 74
- OBJECT tag (ActiveX), 257–258
- object-oriented databases (OODB) for access control, 92
- object-relational databases for access control, 92
- obsolete data, destroying, 132
- OCTAVE (Operationally Critical Threat, Asset, and Vulnerability Evaluation), 595
- OECD (Organization for Economic Cooperation and Development), 22
- OFB (output feedback), 464, 465
- OFDM (Orthogonal Frequency Division Multiplexing), 396–397
- OMB (Office of Management and Budget) Circular A-130, 601–602
- 1G wireless systems, 386–387
- one-time passwords, 85
- one-way functions. *See* hash functions (hash codes)
- OODB (object-oriented databases) for access control, 92
- Oorschot (*Handbook of Applied Cryptography*), 458
- Open Shortest Path First (OSPF), 372
- open source implementations. *See also* UNIX security
 - cryptography algorithms, 476–477
 - defined, 156
 - security issues, 156, 158–160
- Open Systems Interconnect model. *See* OSI model
- open-box penetration test, 610
- operating safely using e-mail
 - architectural considerations, 302–303
 - being paranoid, 300–301
 - encryption for, 307
 - keeping current with applications, 302
 - mail client configurations, 301
 - SSH for, 118–119, 303–307
- operating servers safely
 - controlling the server configuration, 354–356
 - controlling users and access, 356
 - key aspects, 354
 - monitoring, auditing, and logging, 357–358
 - passwords, 357

- operating UNIX safely
 - controlling processes, 174–187
 - controlling users, 187–194
 - detecting services, 180–182
 - encryption and certificates, 194–196
 - file permissions, 188–190
 - malcode protection, 174
 - processes controlling processes, 183–187
 - root access, 192–194
 - services to avoid, 175–176
 - setting the UID/GID flags, 190–191
 - uncommon services, 178–179
 - useful services, 176–178
 - operating Web browsers safely
 - avoiding using private data, 223–224
 - avoiding viruses, 220
 - general recommendations, 224–225
 - keeping current with patches, 220
 - overview, 219
 - securing the network environment, 222
 - using a secure proxy, 223
 - using secure sites, 220–222
 - operating Windows safely
 - adhering to policies, 130
 - avoiding malicious code, 132–133
 - avoiding null sessions, 136–137
 - backing up frequently, 137
 - configuration control, 127–130
 - configuration issues, 125–127
 - enforcing good data handling, 130–132
 - limiting NetBIOS use, 135
 - minimizing administrator account use, 130
 - operating issues, 130–137
 - physical security issues, 124–125
 - separating risky behavior, 122–123
 - using good passwords, 133–135
 - operational security controls, 42
 - Operationally Critical Threat, Asset, and Vulnerability Evaluation (OCTAVE), 595
 - operation/maintenance phase of the SDLC
 - activities, 30–31
 - described, 22
 - risk management in, 33
 - table summarizing, 26–28
 - operations in Defense-in-Depth, 8–10
 - Organization for Economic Cooperation and Development (OECD), 22
 - organizational processes of SSE-CMM, 593
 - Orthogonal Frequency Division Multiplexing (OFDM), 396–397
 - OSI (Open Systems Interconnect) model. *See also specific layers*
 - Application layer, 368, 369–370
 - Data Link layer, 369, 373–374
 - mnemonic for layers, 368
 - Network layer, 369, 372–373
 - overview, 368–369
 - Physical layer, 369, 374–375
 - Presentation layer, 368, 370
 - Session layer, 368, 370–371
 - Transport layer, 369, 371–372
 - WAP and, 415–416
 - OSPF (Open Shortest Path First), 372
 - OTP (one-time pad) cryptography, 453–454, 462, 540
 - Outlook (Microsoft)
 - as collaboration tool, 274
 - security zones, 301
 - output feedback (OFB), 464, 465
 - overlapping fragment attack, 562
- ## P
- packet filtering
 - advantages and disadvantages, 431–432
 - defined, 430
 - firewalls for, 430–433
 - with iptables (UNIX), 199–200
 - metrics employed by, 430–431
 - protocols and, 431
 - rule base or ruleset, 430
 - stateful, 432–433
 - packet fragmentation
 - defined, 374
 - teardrop attack and, 560
 - packet sniffing
 - reverse DNS lookups and, 317–318
 - Windows security and, 152
 - pairwise master key (PMK), 408
 - pairwise transient key (PTK), 408–409
 - PANAMA stream cipher, 462
 - PAP (Password Authentication Protocol), 94
 - Paperwork Reduction Act (PRA), 601
 - PARAM tag (ActiveX), 258
 - parametric curves for anomaly detection, 439
 - parasites, browser, 218–219
 - partial knowledge penetration test, 609
 - partitioning, physical security and, 163–164
 - PAs (process areas) of SE-CMM, 592–593
 - passive attacks
 - defined, 8–9
 - eavesdropping, 566
 - passphrases, 85
 - Password Authentication Protocol (PAP), 94
 - passwords
 - asterisks when entering, 344
 - for authentication, 85
 - BIOS (UNIX), 161
 - checking strong passwords (UNIX), 198–199
 - dynamic, 85
 - embedded in code, 159
 - encrypting, 344–345
 - guessing attacks, 565
 - in Kerberos, 533, 536
 - LANMAN passwords and Windows versions, 140
 - length of, 133
 - for LILO prompt (UNIX), 162
 - mathematical attacks, 563

- Microsoft recommendations, 104
- one-time, 85
- passphrases, 85
- password-cracking programs (UNIX), 198–199
- requirements recommended, 133–135
- server security and, 357
- Single Sign-On (SSO), 86
- software development and, 344–345
- static, 85
- strong, features of, 113, 133–135, 357
- in Windows security, 104, 113, 133–135
- patches. *See* updates, upgrades, and patches
- PATRIOT Act, 576
- pattern matching in IDSs, 440–441, 568, 570
- PC physical controls, 69
- PC surveillance tools, 149
- pcmcia service (UNIX), 176
- PCs, physical controls for, 69
- PDC (personal digital cellular), 388, 392
- peak signal-to-noise ratio (PSNR) Test, 526
- peer-to-peer applications, 362–363
- penetration testing
 - closed-box test, 610
 - defined, 607
 - as ethical hacking, 607
 - external penetration test, 609
 - full knowledge test, 609
 - internal penetration test, 608–609
 - monitoring and, 612
 - open-box test, 610
 - partial knowledge test, 609
 - phases of, 608
 - zero knowledge test, 609
- people, Defense-in-Depth and commitment of, 7
- performance
 - of biometrics, measures for, 71, 86
 - digital signing and, 470–471
 - hash functions and, 471
 - packet filtering and, 431
 - proxy firewalls and, 435
 - SSL issues, 215–216, 351
 - symmetric versus asymmetric encryption, 468
 - Windows security and, 141–142
- perimeter defense strategies, 419–420. *See also specific strategies*
- perimeter intrusion detectors, 69
- period, 381
- peripheral switch controls, 69
- Perl scripting language
 - for CGI scripts, 252
 - security issues, 157
- permissions
 - execution permission in UNIX, 158
 - Java, 256–257
 - UNIX file permissions, 188–190
 - Windows file permissions, 111
- persistent connections (HTTP), 244, 246–248
- persistent versus nonpersistent cookies, 209, 242
- Personal data classification, 132
- personal digital cellular (PDC), 388, 392
- Petitcolas, Fabien (Stir Mark creator), 526
- PGP (Pretty Good Privacy)
 - confidentiality, 532
 - creation of, 531
 - digital signature scheme, 531–532
 - for e-mail, 307, 531–532
 - installing on Windows workstations, 119
 - MIME versus, 530
 - PKI and, 539
 - services, 531
 - session key, 532
- photoelectric sensors, 69
- photo-image cards, 69
- PHP pages, 253
- PHY (physical) layer in wireless LANs, 397, 398
- physical attacks, 149–150
- physical controls
 - detective/physical access control, 83
 - for physical security, 68–69
 - preventive/physical access control, 82
- Physical layer (OSI)
 - overview, 369, 374
 - standards, 374–375
- physical (PHY) layer in wireless LANs, 397, 398
- physical security
 - administrative controls, 70, 72
 - attacks against workstations, 149–150
 - backups and, 137, 164–165
 - detecting hardware changes, 162–163
 - detection and, 165
 - disk partitioning and, 163–164
 - environmental issues, 72–73
 - fire suppression, 73–74
 - inventory and, 165
 - keeping strangers off systems, 124–125
 - limiting physical access, 161–162
 - object reuse and data remanence, 74
 - physical controls, 68–69
 - for servers, 354–355
 - software exploitation and, 566
 - technical controls, 69–70, 71
 - threats, 67
 - UNIX security, 160–165
 - for Windows workstations, 120, 124–125
 - for workstations not in use, 124
- pictures. *See also* steganography
 - Web browsers and, 206
 - Web bugs in, 264–265
- ping-of-death attack, 560
- PKI (Public Key Infrastructure). *See also* asymmetric encryption; public key cryptography
 - authentication provided by, 538
 - CAs and, 540–541
 - concept of, 537–538
 - confidentiality provided by, 538, 539

Continued

- PKI (Public Key Infrastructure) (*continued*)
 - confirmation provided by, 538
 - digital signatures, 539
 - integrity provided by, 538
 - Kerberos and, 533
 - key management, 540–541
 - KMI/PKI, 9
 - mathematical background of, 529
 - network applications and services depending upon, 539
 - non-repudiation provided by, 538, 540
 - PGP session key and, 532
 - public and private keys, 538–550
 - security features, 538
 - SSL and, 539, 550, 553–554
 - web of trust, 541
- placing a cellular telephone call, 385–386
- plain authentication for e-mail, 296–297
- plain text, 449
- plugins (Web browser)
 - ActiveX controls, 226, 227–228
 - configuring, 226–230
 - Java applets, 226, 228–229
 - JavaScript or Jscript, 226–227, 229–230
- PMK (pairwise master key), 408
- Point-to-Point Protocol (PPP)
 - defined, 374
 - VPNs based on, 547
- Point-to-Point Tunneling Protocol (PPTP), VPNs based on, 547
- poisoning
 - cache, 327–328, 330
 - cookie, 263
- policies. *See* security policies
- polymorphic viruses, 558
- POP before SMTP authentication for e-mail, 299
- POP or POP3 (Post Office Protocol)
 - authentication, 294–295, 530
 - encryption and, 128–129, 530
 - IMAP versus, 295, 530
 - overview, 294–295, 378
 - POP before SMTP authentication, 299
 - privacy data loss and, 277–281
 - SSH and, 119
 - using IMAP instead, 104
- pop3s service (UNIX), 177
- port controls, 69
- port scanners, 440, 443, 564. *See also* scanning for vulnerabilities
- portmap service (UNIX), 175
- ports (Windows)
 - Microsoft recommendations, 104
 - scanning, 104, 108
 - unnneeded, turning off, 104
 - Windows 2003 new installation example, 108–109
- Post Office Protocol. *See* POP or POP3
- POST request (HTTP)
 - overview, 211, 238–239
 - PUT request versus, 249
 - SSL sessions and, 214
- postgresql service (UNIX), 179
- PPP (Point-to-Point Protocol)
 - defined, 374
 - VPNs based on, 547
- PPTP (Point-to-Point Tunneling Protocol), VPNs based on, 547
- PRA (Paperwork Reduction Act), 601
- pre-master key (SSL), 551
- prepare to respond to intrusions (CERT/CC practice), 580
- Presentation layer (OSI), 368, 370
- preset locks, 68
- pre-shared secret keys, 465
- Pretty Good Privacy (PGP)
 - confidentiality, 532
 - creation of, 531
 - digital signature scheme, 531–532
 - for e-mail, 307, 531–532
 - installing on Windows workstations, 119
 - MIME versus, 530
 - PKI and, 539
 - services, 531
 - session key, 532
- preventive controls
 - detection controls versus, 37
 - as ideal, 622
 - management controls, 41
 - operational security controls, 42
 - preventive/administrative access control, 81
 - preventive/physical access control, 82
 - preventive/technical access control, 82
 - technical controls, 41
- previewing e-mail, avoiding, 301
- primary key, 91
- primitives (cryptographic)
 - asymmetric encryption, 467–471
 - hash functions, 471–473
 - overview, 455–456
 - random number generation, 456–460
 - symmetric encryption, 460–467
- principal in Kerberos authentication, 535
- principle of least privilege, 12, 621
- print daemons (UNIX), 176
- Priority One through Five security incidents, 587–588
- privacy
 - cookies and, 148–149, 209, 263
 - e-mail and privacy data loss, 277–281
 - Internet Explorer settings, 234
 - LDAP issues, 360–362
 - security versus, 202
- Privacy Act of 1974, 36
- Private data classification, 132

private networks, 419
 /proc file system (UNIX), 172–173
 procedures, 46
 process areas (PAs) of SE-CMM, 592–593
 process ID parameter (UNIX), 172–173
 production honeypots, 573, 575
 program, defined, 48
 program management, 23
 program management plan, 48
 program manager
 DoD regulations regarding, 49
 overview, 48
 program policies, 23, 45
 programmable locks, 68
 project processes of SSE-CMM, 593
 proprietary encryption algorithms, 476–477
 protocols. *See also specific protocols*
 defined, 367
 e-mail authentication, 296–300
 e-mail transmission, 290–296, 530
 layered architecture for, 367–378
 in OSI layers, 368–375
 packet filtering and, 431
 remote access authentication, 93–95
 in TCP/IP layers, 377–378
 Provos, Niels (Honeyd developer), 576
 proxy firewalls, 433–434
 proxy servers
 for e-mail, 302
 persistent connections and, 247–248
 using a secure proxy, 223
 prudent man rule, 76
 ps -aux command (UNIX), 184
 ps command (UNIX), 180
 pseudorandom number generation. *See also random*
 number generation
 algorithms for, 457–458
 hash functions for, 458, 472
 overview, 456–457
 PSNR (peak signal-to-noise ratio) Test, 526
 PTK (pairwise transient key), 408–409
 public key cryptography. *See also asymmetric*
 encryption; encryption; PKI (Public Key
 Infrastructure)
 in GNU Privacy Guard (GPG), 195, 307
 in KryptoKnight SSO system (IBM), 90
 in Pretty Good Privacy (PGP), 119, 307, 532
 in Secure Shell (SSH), 548
 in SESAME SSO system, 90
 Public Key Infrastructure. *See* PKI
 public networks, 418
 Purple cryptography machine, 455
 PUT request (HTTP), 249

Q

qualitative loss criteria, 62
 quantitative loss criteria, 62
 quarantining attachments to e-mail, 303

R

r commands (UNIX), 175
 RADIUS (Remote Authentication and Dial-In User
 Service), 93, 403
 random number generation
 algorithms for pseudorandom numbers, 457–458
 as cryptography primitive, 456–460
 hash functions for, 458, 472
 impossibility for computers, 455, 456, 457
 pseudorandom number generators and, 456–457
 substitution ciphers and, 454–455
 user input for, 458
 whitening functions, 459–460
 random script (UNIX), 176
 RARP (Reverse Address Resolution Protocol)
 defined, 373
 IP address determination at bootup and, 427
 packet filtering and, 431
 rawdevices service (UNIX), 176
 RC4 stream cipher, 462
 re-accreditation. *See* accreditation
 rebooting, UNIX security and, 161–162
 recertification. *See* certification
 recovery controls, 41
 recovery time frame objectives, 64–65
 recursive queries (DNS), 325–326
 Register.com, 310
 Registry (Windows), 111
 regulatory policies, 45
 relation, defined, 91
 relational databases
 for access control, 90–92
 attributes, 90–91
 data normalization, 92
 example operations, 91
 foreign key, 91
 primary key, 91
 remote access
 Callback authentication method, 95
 CHAP protocol, 94–95
 PAP protocol, 94
 RADIUS service, 93
 SSH and, 548
 TACACS and TACACS+ protocols, 93–94
 VPNs, 543
 Remote Authentication and Dial-In User Service
 (RADIUS), 93, 403
 Remote login (Rlogin), 370
 Remote Procedure Calls (RPC)
 defined, 371
 disabling, 355
 UNIX security issues, 175
 REMOTE_ADDR environment variable, 252
 REMOTE_HOST environment variable, 252
 REMOTE_USER environment variable, 252
 removing digital watermarks, 526

- replay attacks. *See also* man-in-the-middle attacks
 - defined, 152, 204, 216, 284
 - e-mail and, 284–285
 - Kerberos for preventing, 533
 - overview, 561
 - Web browsers and, 217–218
- repudiation attacks, 559
- request and response model (HTTP), 239–242
- request header (HTTP), 240–241
- REQUEST_METHOD environment variable, 252
- research honeypots, 573, 575
- response to attacks (incident handling). *See also* CERT/CC practices
 - automated notice and recovery mechanisms, 588
 - CERT/CC recommended practices, 578–583
 - computer incident response team (CIRT), 568
 - Computer Security and Incident Response Teams (CSIRTs), 585–587
 - critical issues, 578
 - IETF guidance, 583–584
 - information system security policy and, 577–578
 - intrusion detection and, 442, 577–588
 - layered security and IDS, 584–585
 - levels of incidents, 587–588
 - preparing for (UNIX), 164–165
 - preparing for (Windows), 145
 - reporting incidents to CSIRT, 587
 - security incident notification process, 587–588
- restricted sites (Internet Explorer), 234
- results documentation in risk assessment, 40
- return systems to normal operation (CERT/CC practice), 583
- Reverse Address Resolution Protocol (RARP)
 - defined, 373
 - IP address determination at bootup and, 427
 - packet filtering and, 431
- reverse DNS lookups, 316–318
- rexec service (UNIX), 177
- RIP (Routing Information Protocol), 373
- RIP service (UNIX), 179
- risk assessment
 - control analysis, 37
 - control recommendations, 40
 - impact analysis, 38–39
 - likelihood determination, 37–38
 - overview of steps, 35
 - results documentation, 40
 - risk determination, 39–40
 - system characterization, 35–36
 - tasks included in, 31
 - threat identification, 36
 - vulnerability identification, 36–37
- risk, defined, 32, 79, 605
- risk determination
 - mission risk calculation, 39
 - in risk assessment, 39–40
 - risk-level matrix example, 39
- risk management
 - defined, 23
 - evaluation and assessment process, 31, 32, 42
 - key personnel for, 34
 - risk assessment process, 31, 35–40
 - risk mitigation process, 31–32, 40–42
 - SDLC and, 33–42
- “Risk Management Guide for Information Technology Systems” (NIST publication)
 - definitions, 32–33
 - described, 604
 - evaluation and assessment process, 32, 42, 606
 - key personnel, 605
 - OMB Circular A-130 and, 604
 - residual risk, 606
 - risk assessment process, 31, 35–40, 605
 - risk defined, 32, 605
 - risk management activities, 34
 - risk mitigation process, 31–32, 40–42, 606
 - table summarizing, 33–34
- risk mitigation
 - categories of controls, 41–42
 - options, 40–41
 - tasks included in, 31–32
- risky personality behaviors (Windows), 123
- Rivest, Ronald (MD5 creator), 539
- Rivest, Shamir, and Adleman algorithm. *See* RSA algorithm
- Rlogin (Remote login), 178, 370
- robustness, 9
- role-based access control, 81
- rolling or mobile backup, 66
- Roman Empire steganography, 488–489
- root access (UNIX), 192–194
- routers
 - as network segment boundaries, 418
 - overview, 423
 - packet filtering firewalls integrated into, 431
- routing algorithms, 423
- Routing Information Protocol (RIP), 373
- RPC (Remote Procedure Calls)
 - defined, 371
 - disabling, 355
 - UNIX security issues, 175
- rpm command (UNIX), 167
- RSA (Rivest, Shamir, and Adleman) algorithm
 - basic steps, 458
 - as cryptographically secure, 457
 - implementation problem with, 475
 - mathematical attack on, 563
 - PKI and, 539
- rsh service (UNIX), 178
- rsync service (UNIX), 178
- rule-based access control, 80

S

- SAs (security associations), 545
- scanning for vulnerabilities
 - firewalls and, 429
 - IDSs and, 440
 - knowledge gained by, 443
 - Nessus utility for (UNIX), 157
 - port scanners for, 440, 443, 564
 - war driving, 567
 - in Windows, 141
- schema of database, 90
- script kiddies, 100
- scripting
 - cross-site, 346–347
 - disabling for e-mail, 301, 303
 - dynamic, 348
 - UNIX security and, 157, 158
- scripts
 - CGI, 252
 - Web browsers and, 206
- SDLC (systems development life cycle)
 - development/acquisition phase, 21
 - disposal phase, 22
 - implementation phase, 21–22
 - information systems security and, 22–31
 - initiation phase, 21
 - NIST definition of, 21
 - operation/maintenance phase, 22
- SE (systems engineering)
 - corresponding SE and ISSE activities, 19–21
 - definitions of, 5–6
 - “generic” processes, 11
 - ISSE processes based on, 11
 - processes, 10–11
- SEAL stream cipher, 462
- secret communication. *See* cryptography; encryption
- Secure European System for Applications in a Multivendor Environment (SESAME), 90
- secure FTP (sFTP)
 - defined, 369
 - installing on Windows workstations, 119
- Secure Hash Algorithms (SHA), 539
- Secure Password Authentication (SPA), 298–299
- Secure Shell. *See* SSH
- Secure Sockets Layer. *See* SSL
- secure Web sites, SSL for, 220–222
- security associations (SAs), 545
- security awareness training
 - as antivirus protection, 116, 117
 - employee cooperation and, 615–616
 - importance of, 46
 - measuring awareness, 47
 - security awareness defined, 46
 - server security and, 338–339
 - types of, 47
- “Security Considerations in the Information System Development Life Cycle” (NIST publication)
 - described, 22, 25, 606–607
 - information systems security in the SDLC (table), 26–28, 607
- security incident notification process, 587–588
- Security layer (WAP), 415–416
- security policies
 - adhering to, 130
 - advisory policies, 45
 - hierarchy of, 44
 - IMP (information management policy), 13
 - incident handling and, 577–578
 - informative policies, 45
 - IPP (Information Protection Policy), 13
 - overview, 43
 - regulatory policies, 45
 - senior management policy statement, 44–45
 - standards, guidelines, procedures, and baselines, 45–46
 - types of, 23
 - U.S. government policy types, 45
- security requirements checklist
 - control mechanism changes and, 37
 - development of, 36
- Security Self-Assessment Guide for Information Technology Systems* (NIST publication), 36
- security tips, 620–623
- SEI (Software Engineering Institute), 595
- select database operation, 91
- semi-private networks, 418–419
- sendmail (UNIX)
 - described, 179
 - not installing unnecessarily, 166
- senior management
 - approval of business continuity plan, 63
 - policy statement, 44–45
 - responsibility for business continuity plan, 63–64
 - risk management and, 34
 - selling security to, 613–614
- Sequenced Packet Exchange (SPX), 372
- Serial Line Internet Protocol (SLIP), 374
- server applications. *See also* software development
 - data sharing, 358–362
 - instant messaging and chat, 363–364
 - peer-to-peer applications, 362–363
- server security
 - attacks on Web servers, 266–268
 - auditing, 357–358
 - business impact assessment, 339–340
 - CCB responsibilities, 341–342
 - controlling the server configuration, 354–356
 - controlling users and access, 356
 - Defense-in-Depth strategy, 336–337
 - by design, 334–353
 - development environment for, 340–343
 - development practices, 344–351
 - factors affecting design efforts, 334
 - general risks, 333–334
 - GET request and, 250
 - keeping things simple, 337
 - logging, 357–358
 - management support and, 341

Continued

- server security (*continued*)
 - mindset for, 335–340
 - minimizing services, 355
 - monitoring, 357–358
 - network support for development, 343
 - operating servers safely, 354–358
 - overview, 364
 - passwords, 357
 - physical security, 354–355
 - PUT request and, 249
 - respecting the adversary, 338
 - risk-based controls, 335–336
 - security awareness programs, 338–339
 - separation in Defense-in-Depth strategy, 99
 - server applications, 358–364
 - testing, 343, 351–353
- servers. *See also* server security; *specific kinds*
 - address information optimization in, 316, 317, 318
 - authentication servers, 534
 - CGI scripts and, 252
 - client/server model, 248–249
 - dedicated e-commerce servers, 270
 - PHP pages and, 253
 - server-side active content, 254–259
 - as verifiers in Kerberos authentication, 535
 - servers service (UNIX), 178
 - service bureaus as backup service, 66
 - service command (UNIX), 187
 - Service Set Identity (SSID), 401
 - services, minimizing or disabling, 355
 - services (UNIX). *See also specific services*
 - chkconfig command manipulation of, 185–186
 - detecting, 180–182
 - host service security issues, 174
 - init process and, 183–184
 - run via xinetd or inetd, 177–178, 184–185
 - service command for, 187
 - services to avoid, 175–176
 - uncommon services, 178–179
 - useful services, 176–178
 - SESAME (Secure European System for Applications in a Multivendor Environment), 90
 - session hijacking. *See* hijacking
 - session ID (SSL), 550
 - session key
 - in Kerberos, 535
 - in PGP, 532
 - Session layer (OSI)
 - functions, 371
 - gateways and, 424
 - overview, 368, 370
 - protocols, 371
 - Session layer (WAP), 415
 - session replay. *See* replay attacks
 - sessions (HTTP)
 - authentication over, 210–211
 - defined, 206
 - request and response model, 239–242
 - simple HTTP session, 207–208
 - SSH sessions, 305
 - tracking for security, 356
 - typical SSL session, 213–215
 - Set-Cookie header, 261–262
 - setting the UID/GID flags (UNIX), 190–191
 - sFTP (secure FTP)
 - defined, 369
 - installing on Windows workstations, 119
 - sgi_fam service (UNIX), 178
 - SGML (Standard Generalized Markup Language), 251
 - sh scripting language (UNIX), 157
 - SHA (Secure Hash Algorithms), 539
 - Shannon/Hartley channel capacity formula, 393–395
 - sharing keys in symmetric encryption, 465–467
 - SHF (Super High Frequency), 383
 - signature-based IDss, 568, 570
 - signatures (antivirus software updates), 116, 139–140
 - signatures, digital. *See* digital signing
 - SIM (Subscriber Identity Module), 383–384
 - Simple Mail Transfer Protocol. *See* SMTP
 - Simple Network Management Protocol (SNMP), 370
 - sine wave characteristics, 381–382
 - Single Sign-On (SSO)
 - advantages and disadvantages, 86–87
 - implementation methods, 87
 - Kerberos, 87–89, 532–533
 - KryptoKnight system (IBM), 90
 - SESAME, 90
 - single user mode (Linux), 161–162
 - single-key encryption. *See* symmetric encryption or symmetric key cryptography
 - Site Security Handbook* (IETF publication), 583–584
 - site-to-site VPNs, 543–544
 - SLIP (Serial Line Internet Protocol), 374
 - slow start algorithm (HTTP), 244, 245
 - Slurpie password cracker (UNIX), 199
 - smart cards, 69
 - smb service (UNIX), 179
 - SMTP (Simple Mail Transfer Protocol)
 - data encryption not provided by, 128–129
 - defined, 369
 - disabling, 355
 - downloading new application versions, 302
 - overview, 290–293
 - POP before SMTP authentication, 299
 - privacy data loss and, 277–281
 - typical conversation, 291–293
 - smurf attack, 560
 - SNMP (Simple Network Management Protocol), 370
 - snmpd service (UNIX), 179
 - Snort IDS, 435
 - social engineering, 75, 152–153, 563
 - software development. *See also* designing secure servers; server applications
 - choosing the language, 345–346
 - Defense-in-Depth strategy, 337
 - handling data, 344–345

- input validation and content injection, 346–349
- keeping code clean, 345
- network support for, 343
- secure practices, 344–351
- stored procedures and, 348
- testing, 343, 351–353
- trust boundaries, 337
- using encryption, 349–351
- Software Engineering Institute (SEI), 595
- software exploitation, 565–566
- source-routed frames (UNIX), 168
- SP 800-12, “An Introduction to Computer Security” (NIST publication), 45
- SP 800-14. *See* “Generally Accepted Principles and Practices for Securing Information Technology Systems” (NIST publication)
- SP 800-26, *Security Self-Assessment Guide for Information Technology Systems* (NIST publication), 36
- SP 800-27. *See* “Engineering Principles for Information Technology Security” (EP-ITS) (NIST publication)
- SP 800-30. *See* “Risk Management Guide for Information Technology Systems” (NIST publication)
- SP 800-64. *See* “Security Considerations in the Information System Development Life Cycle” (NIST publication)
- SPA (Secure Password Authentication), 298–299
- spam
 - blacklisting, 287
 - defined, 285, 443
 - DoS attacks, 286–287
 - filters, 287–288
 - IDSs and, 440
 - overview, 285–286
 - profitability of, 285
 - steganography mimicking, 519–520
- Spam Mimic steganographic program, 519–520
- Spitzner, Lance (HoneyPot Project president), 573
- split DNS design, 328
- split-split DNS design, 328–329
- spoofing
 - AOL DNS update from spoofed e-mail, 320–321
 - ARP, 282–284
 - cache poisoning, 327–328, 330
 - DNS, 327–328
 - firewalls and, 429
 - overview, 560–561
 - packet filtering and, 431
 - smurf attack, 560
- spread spectrum technology
 - defined, 393
 - direct sequence (DSSS), 395
 - fast frequency hopping (FFHSS), 396
 - frequency hopping (FHSS), 395–396
 - low frequency hopping (LFHSS), 396
 - Orthogonal Frequency Division Multiplexing (OFDM), 396–397
 - Shannon/Hartley channel capacity formula, 393–395
- spreadsheet steganography example, 490
- SPX (Sequenced Packet Exchange), 372
- spyware
 - cookies and, 148–149
 - defined, 148
 - PC surveillance tools, 149
 - risks from, 148
 - Windows security and, 148–149
- SQL (Structured Query Language)
 - defined, 267, 371
 - example database, 267
 - injection, 268, 347–348
 - stored procedures, 348
- SSAA (System Security Authorization Agreement), 596–597
- SSE (systems security engineering), 5
- SSE-CMM (Systems Security Engineering Capability Maturity Model), 592–593
- SSH (Secure Shell)
 - advantages and disadvantages, 306–307
 - configuring e-mail clients, 305–306
 - described, 303
 - e-mail security and, 118–119, 303–307
 - encryption, 195–196
 - establishing a session, 305
 - installing on Windows workstations, 118–119
 - mail command with, 304
 - overview, 303–304
 - PKI and, 539
 - remote access and, 548
 - setting up a tunnel, 304–306
 - versions, 548
 - VPNs and, 548
- sshd service (UNIX), 176
- SSID (Service Set Identity), 401
- SSL (Secure Sockets Layer)
 - benefits of encryption, 212–213
 - certificates, 213–215, 550–552
 - “change cipher spec” message, 552
 - client key exchange, 551
 - defined, 212
 - development of, 549
 - “finish” message, 552
 - firewalls and, 553–554
 - functional layout, 549
 - handshake, 550–553
 - introduction of, 213
 - for operating Web browsers safely, 220–222
 - overview, 549
 - performance issues, 215–216, 351
 - PKI and, 539, 550, 553–554
 - pre-master key, 551
 - record protocol, 553–554

Continued

- SSL (Secure Sockets Layer) (*continued*)
 - session ID, 550
 - software development and, 349, 350–351
 - Transport Layer Security (TLS), 403, 415, 539, 554
 - typical session, 213–215
- SSO (Single Sign-On)
 - advantages and disadvantages, 86–87
 - implementation methods, 87
 - Kerberos, 87–89, 532–533
 - KryptoKnight system (IBM), 90
 - SESAME, 90
- stable personality behaviors (Windows), 122–123
- Standard Generalized Markup Language (SGML), 251
- standards. *See also specific standards*
 - auditing, 610
 - Bluetooth, 413
 - defined, 45
 - HTML, 251
 - OSI model, 368–369
 - Physical layer (OSI), 374–375
 - Presentation layer (OSI), 370
 - in security policies, 45–46
 - SQL, 267
 - TEMPEST, 267
 - wireless transmission systems, 388–393
- state
 - applications needing, 260
 - cookies for tracking, 261–264
 - defined, 260
 - hidden fields for tracking, 266
 - hidden frames for tracking, 265–266
 - HTTP as stateless, 206, 260
 - maintaining by Web browsers, 210–211
 - tracking in HTTP, 261
 - URL tracking, 265
 - Web bugs, 264–265
- stateful packet-filtering techniques, 432–433
- statement of work, 50
- static passwords, 85
- static rules for anomaly detection, 440
- statistical anomaly-based IDSs, 439–440, 568, 571
- stealth viruses, 558
- Steganographia* (Trithemius), 481
- steganographic programs
 - Camouflage, 516–517
 - Digital Picture Envelope (DPE), 514–516
 - EZ-Stego, 511–512
 - Gif Shuffle, 517–518
 - Hide and Seek, 506–507
 - Image Hide, 512–514
 - Jsteg, 508–511
 - Spam Mimic, 519–520
 - S-Tools, 503–506
- steganography. *See also* cryptography; digital watermarking
 - advantages of, 484–485
 - algorithmic-based, 496–497
 - amount of data and, 493
 - availability and, 491
 - color tables and, 501–502, 511–512
 - confidentiality and, 490
 - core areas of network security and, 490–492
 - covert channels versus, 486–487
 - cryptography versus, 479, 493–495
 - Defense-in-Depth strategy and, 485
 - defined, 479, 482
 - detection and, 492, 493
 - digital dead drop, 484–485
 - digital watermarking, 481, 520–526
 - digital watermarking versus, 524
 - disadvantages of, 485
 - ease of removal and, 493
 - Easter eggs versus, 487
 - encryption with, 480, 493–495
 - with the environment, 489
 - future of, 482
 - generation technique, 501
 - grammar-based, 497
 - graphic example, 479–481
 - history of, 488–489
 - insertion technique, 498–500
 - insertion-based, 496
 - integrity and, 491
 - invisibility and, 492
 - least significant bits (LSB) for, 496, 503–504
 - microdots, 481
 - need for, 483–484
 - origins of, 481
 - overview, 482–487, 526–527
 - principles of, 492–493
 - protecting your ring example, 493
 - public interest in, 484
 - substitution technique, 500–501
 - survivability and, 491–492
 - tools for implementing, 503–520
 - Trojan horses versus, 486
 - types of, 495–502
 - uses for, 481, 482, 484
 - Word examples, 498–500, 501
- Stir Mark program (Petitcolas, Fabien), 526
- S-Tools steganographic program
 - capabilities, 503
 - for images, 503–504
 - using, 504–506
- stored procedures, 348
- strace command (UNIX), 170–172
- stream ciphers
 - one-time pad, 453–454, 462
 - overview, 462–463
- Structured Query Language (SQL)
 - defined, 267, 371
 - example database, 267
 - injection, 268, 347–348
 - stored procedures, 348
- subdomains, 311
- subject, defined, 79

- subnet masks, 424
 - subnetting
 - overview, 424
 - semi-private networks as subnets, 418–419
 - switching and, 425
 - Subscriber Identity Module (SIM), 383–384
 - substitution ciphers
 - defined, 449
 - key for, 450
 - one-time pad, 453–454, 462, 540
 - overview, 449–450
 - random number generators for, 454–455
 - Vigenere cipher, 450–453
 - XOR function for, 454
 - substitution steganography, 500–501
 - Super High Frequency (SHF), 383
 - surveillance tools for PCs, 149
 - survivability as goal of steganography, 491–492
 - switch control, 69
 - switches
 - IDS issues, 572
 - as network segment boundaries, 418
 - overview, 423
 - switching overview, 425
 - Symantec
 - antivirus software, 103, 117
 - IDS, 436
 - symmetric encryption or symmetric key cryptography
 - block ciphers, 463–465
 - cast of characters for examples, 460
 - computationally secure, 461–462
 - in Kerberos, 87–89, 532–533
 - overview, 460–462
 - performance and, 468
 - in SESAME SSO system, 90
 - sharing keys, 465–467
 - stream ciphers, 462–463
 - in WEP, 400–402
 - SYN attack, 560
 - sys directory (UNIX), 173
 - SysCop digital watermarking program (MediaSec Technologies), 525
 - syslog process (UNIX), 176
 - sysstat command, disabling, 355
 - system calls
 - defined, 170
 - tracing (UNIX), 170–172
 - UNIX security, 170–172
 - system characterization in risk assessment, 35–36
 - system hardening. *See* hardening UNIX systems; hardening Windows systems
 - system infector viruses, 558
 - System Security Authorization Agreement (SSAA), 596–597
 - systems development life cycle (SDLC)
 - development/acquisition phase, 21
 - disposal phase, 22
 - implementation phase, 21–22
 - information systems security and, 22–31
 - initiation phase, 21
 - NIST definition of, 21
 - operation/maintenance phase, 22
 - systems engineer tasks, 17
 - systems engineering (SE)
 - corresponding SE and ISSE activities, 19–21
 - definitions of, 5–6
 - “generic” processes, 11
 - ISSE processes based on, 11
 - processes, 10–11
 - systems engineering management plan
 - contents of, 48–49
 - overview, 48
 - principle headings in, 49–50
 - statement of work, 50
 - technical performance measurement (TPM), 54
 - test and evaluation master plan (TEMP), 55
 - work breakdown structure (WBS), 51–53
 - Systems Security Engineering Capability Maturity Model (SSE-CMM), 592–593
 - systems security engineering (SSE), 5
 - system-specific policies, 23, 45
- ## T
- TACACS and TACACS+ (Terminal Access Controller Access Control System), 93–94
 - TACS (Total Access Communication System), 389, 391
 - Tagged Image File Format (TIFF), 370
 - talk service (UNIX), 178
 - task-based access control, 81
 - TCP (Transmission Control Protocol)
 - burstable TCP service, 250–251
 - defined, 371–372
 - security cumbersome with, 544
 - sequence number attacks, 567
 - Transport layer and, 424
 - TCP wrapper (UNIX), 198
 - tcpdump utility (UNIX), 156
 - TCP/IP model. *See also specific layers*
 - layers, 377–378
 - overview, 375–377
 - tcpreplay utility (UNIX), 157
 - TDD (Time Division Duplex) mode, 390
 - TDMA (Time Division Multiple Access)
 - for GSM, 388
 - for IMT-2000, 389
 - overview, 386
 - for PDC, 388
 - teardrop attack, 560
 - technical controls
 - detective/technical access control, 83
 - nontechnical controls versus, 37
 - for physical security, 69–70, 71
 - preventive/technical access control, 82
 - technical effort management
 - program management plan, 48
 - program manager, 48
 - systems engineering management plan, 48–55

- technical performance measurement (TPM), 54
- technologies
 - of Defense-in-Depth, 7–8
 - wireless networking, 386–387
- telnet service
 - defined, 178
 - disabling, 355
 - UNIX security issues, 175
- TEMP (test and evaluation master plan), 55
- TEMPEST (transient electromagnetic pulse emanation standard)
 - attacks, 150
 - standard for shielding, 72
- Temporal Key Integrity Protocol. *See* TKIP
- temporal key (TK), 409
- ten common security mistakes, 618–619
- Terminal Access Controller Access Control System (TACACS and TACACS+), 93–94
- test and evaluation master plan (TEMP), 55
- testing. *See also* assessment
 - applications in Windows, 141
 - assurance approaches and methodologies, 591–596
 - disaster recovery plan, 66
 - establishing a test environment, 343
 - hardened Windows systems, 107, 120
 - to identify vulnerabilities, 36
 - penetration testing, 607–610
 - software development and, 343, 351–353, 566
 - test and evaluation master plan (TEMP), 55
 - visualizing requirements for, 352–353
- text, determining if encrypted, 494–495
- TFTP (Trivial File Transfer Protocol), 369
- TGS (Ticket Granting Service) in Kerberos, 87–89, 536
- theft
 - physical security and, 161
 - of private information, 216
- “This Land” parody, 250
- threats
 - defined, 32, 79
 - identification in risk assessment, 36
 - to physical security, 67
- threat-source, 32
- 3G wireless systems, 386, 387
- throughput rate in biometrics, 71, 86
- Ticket Granting Service (TGS) in Kerberos, 87–89, 536
- TIFF (Tagged Image File Format), 370
- Time Division Duplex (TDD) mode, 390
- Time Division Multiple Access (TDMA)
 - for GSM, 388
 - for IMT-2000, 389
 - overview, 386
 - for PDC, 388
- time service (UNIX), 178
- timestamps
 - by Authentication Servers, 534
 - by Kerberos, 533
 - replay attacks and, 561
- tiny fragment attack, 562
- Title III, 576
- TK (temporal key), 409
- TKIP (Temporal Key Integrity Protocol)
 - development of, 402
 - 802.1X authentication, 402–403
 - IV sequencing discipline, 405, 406
 - Message Integrity Code (MIC), 405–407
 - need for, 403
 - pre-packet key missing function, 404–405
 - rekeying against key reuse, 407–408
 - upgrades for WEP weaknesses, 404
- TLS (Transport Layer Security). *See also* SSL (Secure Sockets Layer)
 - as advanced SSL, 554
 - EAPOL support for, 403
 - PKI and, 539
 - WTLS based on, 415
- top-level domain names, 310–315
- topology of cellular telephone networks, 385
- Total Access Communication System (TACS), 389, 391
- TPM (technical performance measurement), 54
- traceroute command, 279
- tracing system calls (UNIX), 170–172
- training. *See* security awareness training
- Transaction layer (WAP), 415
- Transaction Signatures (TSIGs), 323
- transient electromagnetic pulse emanation standard (TEMPEST)
 - attacks, 150
 - standard for shielding, 72
- Transmission Control Protocol (TCP)
 - burstable TCP service, 250–251
 - defined, 371–372
 - security cumbersome with, 544
 - sequence number attacks, 567
 - Transport layer and, 424
- Transport layer (OSI)
 - gateways and, 424
 - overview, 369, 371
 - protocols, 371–372, 424
- Transport Layer Security (TLS)
 - as advanced SSL, 554
 - EAPOL support for, 403
 - PKI and, 539
 - WTLS based on, 415
- Transport layer (TCP/IP)
 - MAC addresses and, 426
 - overview, 377
- Transport layer (WAP), 416
- transport mode IPsec-based VPNs, 545
- Trip-wire IDS, 436
- Trithemius (*Steganographia*), 481
- Trivial File Transfer Protocol (TFTP), 369
- Trojan horses. *See also* malicious code (malcode or malware)
 - avoiding, 132–133
 - defined, 147, 558
 - overview, 147–148

- steganography versus, 486
- viruses versus, 558
- Windows security and, 147–148
- true negative IDS result, 441
- true positive IDS result, 441
- trust boundaries, 337
- trusted networks, Windows security and, 103, 115
- trusted signature introducers, 541
- trusted sites (Internet Explorer), 233
- TSIGs (Transaction Signatures), 323
- tunneled mode IPsec-based VPNs, 545
- 2G wireless systems, 386
- two-key encryption. *See* asymmetric encryption

U

- UDP (User Datagram Protocol), 372
- UHF (Ultra-High Frequency), 383
- UID (user ID) flag (UNIX), 189, 190–191
- Ultra-High Frequency (UHF), 383
- UMTS (Universal Mobile Telecommunications Systems), 390, 392
- union database operation, 91
- Universal Mobile Telecommunications Systems (UMTS), 390, 392
- UNIX security
 - backups and, 164–165
 - checking strong passwords, 198–199
 - configuration control, 166–173
 - controlling processes, 174–187
 - controlling users, 187–194
 - detecting hardware changes, 162–163
 - detecting services, 180–182
 - detection and, 165
 - disk partitioning and, 163–164
 - encryption and certificates, 194–196
 - file permissions, 188–190
 - hardening systems, 196–200
 - inventory and, 165
 - journaling and, 163
 - limiting physical access, 161–162
 - listing all installed packages, 167
 - listing all loaded kernel modules, 169–170
 - malcode protection, 174
 - open source issues, 156, 158–160
 - operating UNIX safely, 174–196
 - overview, 200
 - packages that should not be installed unnecessarily, 166
 - packet filtering, 199–200
 - physical, 160–165
 - preparing for attacks, 164–165
 - /proc file system, 172–173
 - processes controlling processes, 183–187
 - root access, 192–194
 - services to avoid, 175–176
 - setting the UID/GID flags, 190–191

- software exploitation (AIX), 565
- TCP wrapper, 198
- tracing system calls, 170–172
- uncommon services, 178–179
- UNIX as a poor target, 157–160
- UNIX vulnerability, 155–157
- useful services, 176–178
- updates, upgrades, and patches
 - for antivirus software, 116, 139
 - for applications, 139
 - automatic update services (UNIX), 166
 - keeping current, 138–140, 623
 - Microsoft recommendations, 103
 - using the most modern Windows version, 140, 142
 - for Web browsers, 220
 - for Windows, 138–139
 - Windows security and, 103, 138–140
- URL tracking, 265
- U.S. Constitution, 576
- U.S. Department of Defense. *See* DoD
- U.S. government policy types, 45
- user accounts (Windows)
 - change of user status and, 126–127
 - checking parameters for, 113
 - controlling users, 128
 - good passwords for, 113
 - limiting user rights, 112, 125–126
 - managing, 126–127
 - recommended settings for, 112–113
 - termination of personnel and, 127
- User Datagram Protocol (UDP), 372
- user groups, Windows security and, 111–112
- user ID (UID) flag (UNIX), 189, 190–191
- user input. *See* input to programs
- user management in Defense-in-Depth strategy, 99–100
- user-directed discretionary access control, 80
- utilities, software exploitation and, 566

V

- van Dam, Andries (hypertext developer), 247
- Vanstone (*Handbook of Applied Cryptography*), 458
- variables, checking, 159
- Verance digital watermarking program, 525
- verifier in Kerberos authentication, 535
- Very High Frequency (VHF), 383
- VideoMark digital watermarking program (Alpha Tec Ltd), 525
- Vigenere, Blaise de (cipher inventor), 450
- Vigenere cipher
 - frequency analysis and, 451–453
 - index of coincidence and, 451–452, 453
 - overview, 450–451
- violation analysis, 612
- violation reports from audit trail information, 83
- virtual hosting of e-commerce, 269–270
- virtual local area network. *See* VLAN

- Virtual Private Networks. *See* VPNs
- viruses. *See also* antivirus software; malicious code (malcode or malware)
 - avoiding, 132–133
 - defined, 116, 145, 557
 - means of spreading, 116, 132–133, 146, 557
 - operating Web browsers safely, 220
 - overview, 145–146, 557
 - Trojan horses versus, 558
 - types of, 558–559
 - Windows security and, 116–118, 125, 132–133, 145–146
 - worms versus, 559
- Visa Card Holder Information Security Program (CISP), 222
- visible watermarking, 523
- visitor location register (VLC), 384
- Visual Basic, disabling, 146
- VLAN (virtual local area network)
 - architecture, 425
 - for developers, 343
 - separation in Defense-in-Depth strategy, 99
- VLC (visitor location register), 384
- VolMark digital watermarking program (Alpha Tec Ltd), 525
- Von Neumann (whitening function creator), 459
- VPNs (Virtual Private Networks)
 - design issues, 543–544
 - encryption, 349
 - IPSec-based, 544–547
 - PPTP/PPP-based, 547
 - remote access VPNs, 543
 - Secure Shell (SSH) and, 548
 - as semi-private network, 419
 - site-to-site or LAN-to-LAN VPNs, 543–544
 - typical connection, 542
 - uses for, 542
 - as WAN security backbone, 541–542
- vsftpd service (UNIX), 175
- vulnerability
 - assessment, 61–62
 - defined, 32, 79
 - DNS statistics, 327
 - e-mail data vulnerabilities, 273–274
 - identification in risk assessment, 36–37
 - NIST database, 36
 - open source implementations and, 156, 158–160
 - scanning Windows system for, 141
 - of UNIX systems, 155–160
- W**
- WAN (wide area network)
 - separation in Defense-in-Depth strategy, 99
 - VPNs as security backbone, 541–542
- WAP (Wireless Application Protocol), 414–416
- war dialing attacks, 567
- war driving, 567
- war, steganography in, 489
- warm backup site, 65
- watermarking. *See* digital watermarking
- wavelength
 - defined, 381
 - relationship between frequency and, 382
- WBS (work breakdown structure)
 - aircraft system example, 52–53
 - defined, 51
 - levels of activity, 51
 - overview in *Department of Defense Handbook*, 51
- W-CDMA technology, 390
- Web browsers. *See also* cookies; Internet connection
 - attacks, 216–219
 - authentication over sessions, 210–211
 - avoiding using private data, 223–224
 - avoiding viruses, 220
 - caching by, 212, 231
 - categories of security risks, 204
 - client risk and, 201–205
 - configuration items, 225–236
 - convenience of, 201, 202
 - disabling ActiveX controls, 227–228
 - disabling Java applets, 228–229
 - disabling JavaScript or Jscript, 229–230
 - evolution of, 203–204
 - general recommendations for using, 224–225
 - how they work, 205–216
 - HTTP protocol and, 205–208
 - information returned using, 205–206
 - Internet Explorer-specific issues, 231–236
 - issues working against attackers, 205
 - keeping current with patches, 220
 - maintaining state and, 210–211
 - Netscape-specific issues, 230–231
 - operating safely, 219–225
 - overview, 236
 - parasites, 218–219
 - plugins and, 226–230
 - privacy versus security, 202
 - productivity and popularity of, 201, 202–203
 - risky personalities and, 123
 - secure proxy for, 223
 - securing the network environment, 222
 - SSL and, 212–216, 220–222, 549
 - stable personalities and, 122
 - as targets for hackers, 201
 - user groups for browsing rights, 125
 - Windows business workstation security, 114
 - Web bugs, 264–265
 - web of trust for asymmetric encryption, 469–470, 541
 - Web security. *See also* cookies; HTTP (Hypertext Transfer Protocol)
 - attacks on Web servers, 266–268
 - client content, 254–259
 - e-commerce design and, 269–271
 - server content, 252–253
 - state and, 260–266
 - transition from FTP to HTTP and, 237

- Web server attacks
 - account harvesting, 266–267
 - SQL injection, 267–268, 347–348
- Web sites. *See* Internet resources
- WEP (Wired Equivalent Privacy)
 - defined, 400
 - 802.1X authentication, 402–403
 - Initialization Vector (IV) for symmetric key, 400
 - open authentication, 401
 - overview, 400–401
 - Service Set Identity (SSID), 401
 - shared key authentication, 401–402
 - Temporal Key Integrity Protocol (TKIP), 402, 403–408
 - upgrades, 402–408
 - weaknesses of, 400
- “white hat” hackers, 160
- whitening functions for pseudorandom number generation, 459–460
- wide area network (WAN)
 - separation in Defense-in-Depth strategy, 99
 - VPNs as security backbone, 541–542
- Windows Internet Name Service (WINS), 108
- Windows security. *See also* hardening Windows systems
 - administrator account, 112, 130
 - architecture for workstations and, 120–121
 - attacks against workstations, 145–153
 - auditing, 144
 - AUTORUN and, 111
 - backups for, 137
 - for business workstations, 114
 - cleaning up the system, 144
 - Defense-in-Depth strategy and, 99–100
 - ease of installation and, 101–102
 - ease-of-use versus, 101
 - file extension hiding and, 151
 - file permissions and, 111
 - firewalls, 103, 104, 114, 118, 121–122
 - for gaming systems, 114–115
 - hardening systems, 99, 103–115
 - importance of, 99, 102
 - installing applications, 115–119
 - intrusion detection systems, 122
 - large installation base and, 101, 102
 - logging, 144
 - maintenance and testing, 140–145
 - Microsoft recommendations, 103–104
 - monitoring, 143
 - NetBIOS and, 108–109, 116, 119, 135
 - NTFS file system and, 111
 - null sessions and, 109, 136–137
 - obtaining list of services, 107
 - operating Windows safely, 122–137
 - overview, 153–154
 - passwords, 104, 113, 133–135
 - performance and, 141–142
 - physical, 120, 124–125
 - preparing for attacks, 145
 - preventing DoS attacks, 151
 - putting the workstation on the network, 120–122
 - re-evaluating and rebuilding periodically, 142–143
 - Registry and, 111
 - scanning for vulnerabilities, 141
 - software exploitation, 565
 - stable versus risky personalities and, 122–123
 - trusted networks and, 103, 115
 - upgrades and patches, 138–140
 - user groups rights and, 111–112
 - user level accounts and, 112–113
 - using the most modern Windows version, 140, 142
- WINS (Windows Internet Name Service), 108
- Wired Equivalent Privacy. *See* WEP
- Wireless Application Protocol (WAP), 414–416
- Wireless Markup Language (WML), 415
- wireless networking
 - ad hoc mode, 398, 428
 - Bluetooth, 413–414
 - cellular phone network, 383–385
 - IEEE 802.11 wireless security, 400–413
 - IEEE wireless LAN standards, 397–399
 - infrastructure mode, 398
 - pervasive wireless data network technologies, 393–397
 - placing a cellular telephone call, 385–386
 - spread spectrum technology, 393–397
 - technologies, 386–387
 - terminology, 381–383
 - transmission systems, 386–393
 - war driving, 567
 - Wireless Application Protocol (WAP), 414–416
- wireless proximity readers, 69
- wireless security
 - 802.11i standard, 408–413
 - WEP overview, 400–402
 - WEP upgrades, 402–408
- Wireless Transactional Protocol (WTP), 415
- wireless transmission systems
 - advanced mobile phone system (AMPS), 388, 391
 - CDMA2000 technology, 390
 - cellular digital packet data (CDPD), 388, 392
 - Enhanced Data rate for GSM Evolution (EDGE), 393
 - Enhanced Total Access Communication System (ETACS), 389, 391
 - General Packet Radio Service (GPRS), 393
 - Global System for Mobile Communications (GSM), 388, 392
 - International Mobile Telephone Standard 2000 (IMT-2000), 389, 392
 - Narrow-Band Total Access Communication System (NTACS), 391
 - Nordic Mobile Telephone (NMT), 389, 391
 - personal digital cellular (PDC), 388, 392
 - technologies, 386–387
 - Total Access Communication System (TACS), 389, 391
 - Universal Mobile Telecommunications Systems (UMTS), 390, 392
 - W-CDMA technology, 390

- Wireless Transport Layer Security (WTLS), 415–416
 - Wiretap Act (1968), 576
 - WML (Wireless Markup Language), 415
 - Word (Microsoft)
 - hidden metadata in documents, 131
 - macro viruses, 558
 - Melissa virus and, 146
 - steganography examples, 498–500, 501
 - word processing
 - user groups for, 125
 - Windows business workstation security, 114
 - work breakdown structure (WBS)
 - aircraft system example, 52–53
 - defined, 51
 - levels of activity, 51
 - overview in Department of Defense Handbook, 51
 - workstation security. *See* UNIX security; Windows security
 - World Wide Web. *See* Web security
 - worms. *See also* malicious code (malcode or malware)
 - avoiding, 132–133
 - defined, 146, 559
 - overview, 146–147
 - viruses versus, 559
 - Windows security and, 146–147
 - WTLS (Wireless Transport Layer Security), 415–416
 - WTP (Wireless Transactional Protocol), 415
 - wuftp service (UNIX), 175
- ## X
- X.509 certificate (SSL), 550–552
 - xfx (X Font server) service (UNIX), 176
 - xinetd service (UNIX)
 - overview, 176, 184–185
 - services run via, 176–177
 - XOR function for cryptography, 454
 - X-Window system, 371
- ## Z
- zero knowledge penetration test, 609
 - Zero-Configuration networks, 428
 - Zimmermann, Phil (PGP creator), 531
 - zone transfers
 - alternatives, 324
 - defined, 322
 - DNS security extensions (DNSSEC), 324
 - historical problems with, 322
 - master slave DNS and, 331
 - specifying transfer sites, 322
 - TSIGs, 323